

OWNER'S MANUAL

AIR CONDITIONER

KTIR
SERIES

KLIMAIRE[®] ≈

Thank you very much for purchasing our air conditioner, please read this owner's manual carefully before using your air conditioner

CONTENT

IMPORTANT SAFETY INFORMATION-----	1
HINTS FOR ECONOMICAL OPERATION-----	2
PARTS NAMES-----	2
MANUAL OPERATION-----	3
ADJUSTING AIR FLOW DIRECTION-----	4
MAINTENANCE-----	5
AIR CONDITIONER OPERATIONS AND PERFORMANCE-----	7
INSTALLATION-----	8
TROUBLES AND CAUSES-----	9
TROUBLES AND CAUSES(CONCERNING REMOTE CONTROLLER)-----	9

IMPORTANT SAFETY INFORMATION

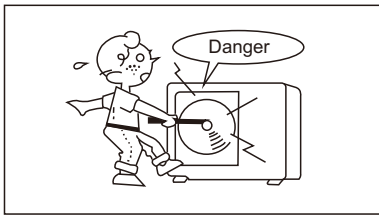

▲ CAUTION

Do not attempt to install this unit by yourself. This unit requires installation by qualified persons.

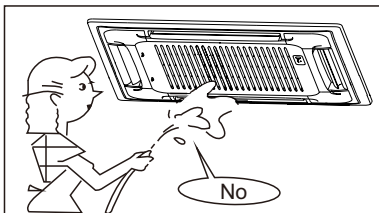

▲ DANGER

Do not attempt to service the unit yourself. This unit has no user serviceable components. Opening or removing the cover will expose you to dangerous voltage. Turning off the power supply will not prevent potential electric shock.

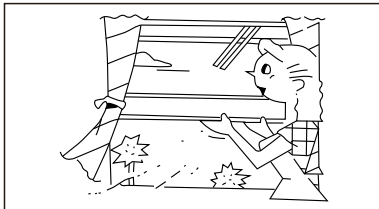

▲ DANGER

To avoid the risk of serious electrical shock, Never sprinkle or spill water or liquids on unit.

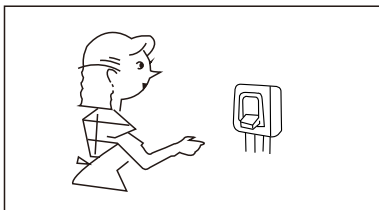

▲ WARNING

Ventilate the room regularly while the air conditioner is in use, especially if there is also a gas appliance in use in this room, Failure to follow these directions may result in a loss of oxygen in the room.

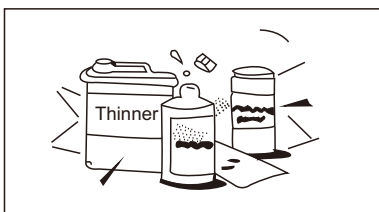

▲ WARNING

To prevent electric shock, turn off the power or disconnect the power supply plug before beginning any cleaning or other routine maintenance. Follow the directions for cleaning in the Owner's Manual.

▲ WARNING

Do not use liquid cleaners or aerosol cleaners, use a soft and dry cloth for cleaning the unit. To avoid electric shock, never attempt to clean the units by sprinkling water.

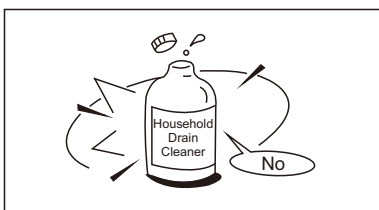

▲ CAUTION

Do not use caustic household drain cleaners in the unit. Drain cleaners can quickly destroy the unit components (drain pan and heat exchanger coil etc).

▲ NOTE

For proper performance, operate the unit in temperature and humidity ranges indicated in this owner's manual. If the unit is operated beyond these conditions, it may cause malfunctions of the unit or dew dripping from the unit.

■ Four-way Cassette(slim) Type

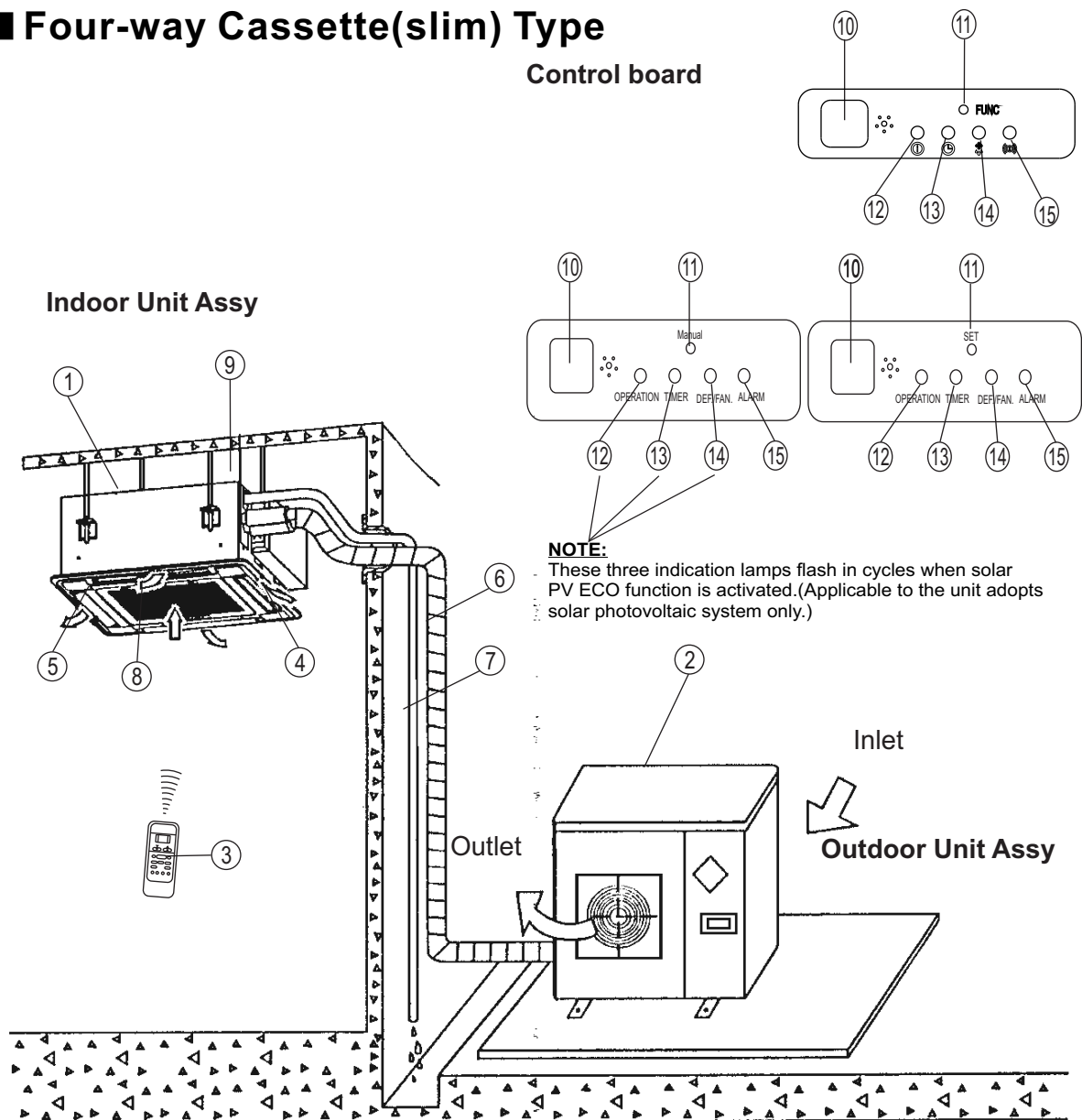

This picture is based on the type of 18000Btu/h, So the appearance and function may be slightly different from the unit you purchased.

Parts Names:

① Indoor Unit	② Outdoor Unit	③ Remote Controller
④ Air outlet	⑤ Vertical louver	⑥ Connecting pipe
⑦ Drain hose	⑧ Air Inlet (Air filter installed inside to prevent the dust)	
⑨ Drain Pump (Internal installed), water drain from indoor unit.		
⑩ Infrared Signal receiver	⑪ Manual button/SET button	⑫ Run lamp
⑬ Timer indicator	⑭ Defrost indicator heating/cooling type or fan indicator (cooling only type)	
⑮ Alarm indicator		

MANUAL OPERATION

■ Ceiling & Floor

This function is used to operate the unit temporarily in case you misplace the remote controller or its batteries are exhausted. Two modes including AUTO and FORCED COOL can be selected through the TEMPORARY BUTTON on the air-in grill control box of the indoor unit. Once you push this button, the air conditioner will run in such order: AUTO, FORCED COOL, OFF, and back to AUTO.

1 AUTO

The OPERATION lamp is lit, and the air conditioner will run under AUTO mode. The remote controller operation is enabled to operate according to the received signal.

2 FORCED COOL

The OPERATION lamp flashes, the air conditioner will turn to AUTO after it is enforced to cool with a wind speed of HIGH for 30 minutes. The remote controller operation is disabled.

3 OFF

The OPERATION lamp goes off. The air conditioner is OFF while the remote controller operation is enabled.

■ Four-way Cassette

This function is used to operate the unit temporarily in case you misplace the remote controller or its batteries are exhausted. Two modes including AUTO and mandatory COOL can be selected through the TEMPORARY BUTTON on the air inlet grill control box of the indoor unit. Once you push this button, the air conditioner will run in such order: AUTO, mandatory COOL, OFF, and back to AUTO.

1 AUTO

The OPERATION lamp is lit, and the air conditioner will run under AUTO mode. The remote controller operation is enabled to operate according to the received signal.

2 MANDATORY COOL

The OPERATION lamp flashes, the air conditioner will turn to AUTO after it is enforced to cool with a wind speed of HIGH for 30 minutes. The remote controller operation is disabled.

3 OFF

The OPERATION lamp goes off. The air conditioner is OFF while the remote controller operation is enabled.

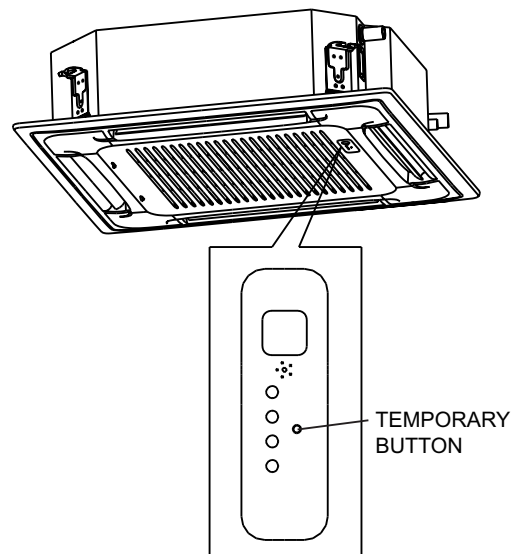

ADJUSTING AIR FLOW DIRECTION

■ Cassette Type

While the unit is in operation, you can adjust the air flow louver to change the flow direction and naturalize the room temperature evenly. Thus you can enjoy it more comfortably.

1. Set the desired air flow direction.

Push the **SWING** button to adjust the louver to the desired position and push this button again to maintain the louver at this position.

2. Adjust the air flow direction automatically.

Push the **SWING** button, the louver will swing automatically.

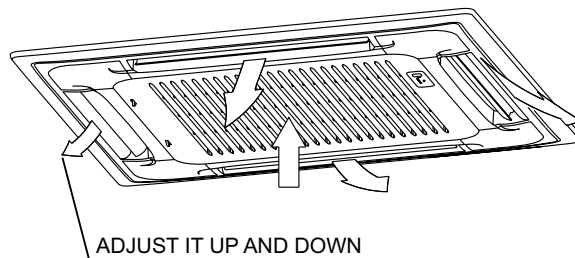

While this function is set, the swing fan of indoor unit runs; otherwise, the swing fan doesn't run. The swing scale of every side is 30°. When the air conditioner isn't in operation (including when "TIMER ON" is set), the **SWING** button will be disabled.

Duct and Ceiling Type

The following is how to adjust air flow direction when air outlet part (separately saled) is used with the indoor unit.

Cooling

To effectively cool the whole room, please set the louver so that the air can come out horizontally.

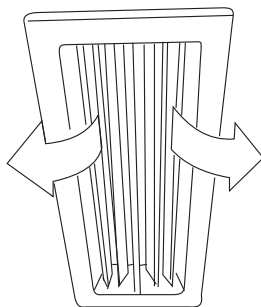

Heating

To effectively heat the bottom of the room, Please set the louver so that the air can come out downwards.

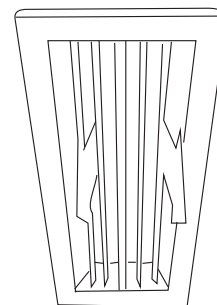

MAINTENANCE

WARNING

WARNING

Before you clean the air conditioner, be sure to disconnect the power supply plug.

Cleaning the indoor unit and remote controller

CAUTIONS

- Use a dry cloth to wipe the indoor unit and remote controller.
- A cloth dampened with cold water may be used on the indoor unit if it is very dirty.
- Never use a damp cloth on the remote controller.
- Do not use a chemically-treated duster for wiping or leave such material on the unit for long, because it may damage or fade the surface of the unit.
- Do not use benzine, thinner, polishing powder, or similar solvents for cleaning. These may cause the plastic surface to crack or deform.

If you do not plan to use the unit for at least 1 month.

- (1) Operate the fan for about half a day to dry the inside of the unit.
- (2) Stop the air conditioner and disconnect power.
- (3) Remove the batteries from the remote controller.

Checks before operation

CAUTIONS

- Check that the wiring is not broken off or disconnected.
- Check that the air filter is installed. (Some air-conditioners haven't air filters.)
- Check that the outdoor unit air outlet or inlet is not blocked.

Before you clean the air conditioner, be sure to disconnect the power supply plug.

Cleaning the air filter

- The air filter can prevent the dust or other particulate from going inside .In case of blockage of the filter , the working efficiency of the air conditioner may greatly decrease .Therefore , the filter must be cleaned once two weeks during long time usage.
- If the air conditioner is positioned in a dust place , the cleaning frequency of the air filter must be increased .
- If the accumulated dust is too heavy to be cleaned , please replace the filter with a new one(replaceable air filter is an optional fitting).
- The filter cleaning should be performed by a suitable service provider.

■ Cassette Type

1. Open the air-in grill

Push the grill switches towards the middle simultaneously as indicated in sketch A. Then pull down the air-in grill.

Cautions: The control box cables ,which are originally connected with the main body electrical terminators must be pulled off before doing as indicated above.

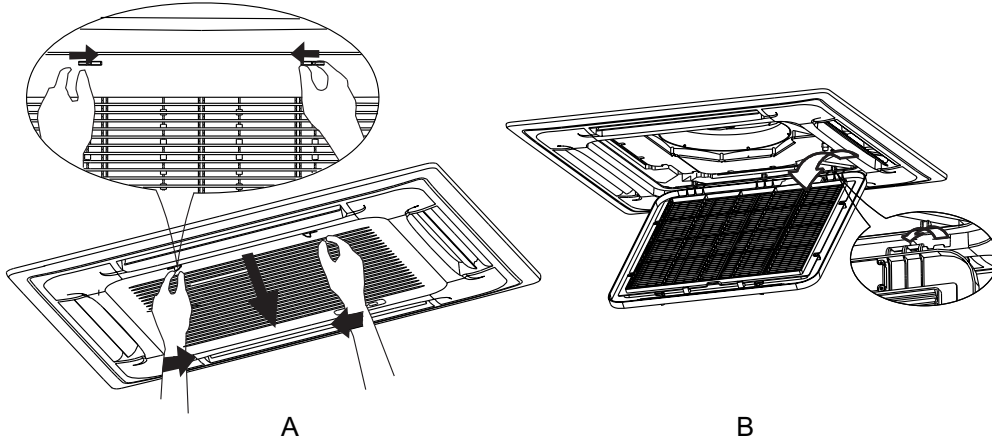

2. Take out the air-in grill (together with the air filter shown in Sketch B)

Pull the air-in grill down at 45 ° and lift it up to take out the grill.

3. Dismantle the air filter

4. Clean the air filter(Vacuum cleaner or pure water may be used to clean the air filter. If the dust accumulation is too heavy , please use soft brush and mild detergent to clean it and dry out in cool place) .

■ Duct and Ceiling Type

1. Open the air-in grill

Push the grill switches towards the middle simultaneously as indicated in follow figure sketch. Then pull down the air-in grill.

Cautions: The control box cables ,which are originally connected with the main body electrical terminators must be pulled off before doing as indicated above.

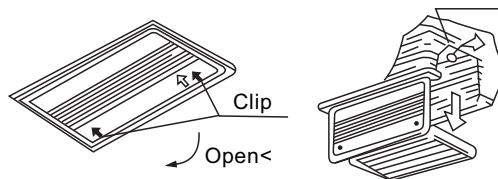

2. Take out the air-in grill.

3. Dismantle the air filter

4. Clean the air filter (Vacuum cleaner or pure water may be used to clean the air filter. If the dust accumulation is too heavy , please use soft brush and mild detergent to clean it and dry out in cool place) .

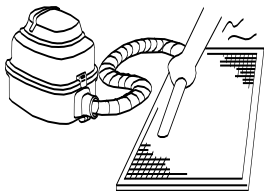

Fig. 1

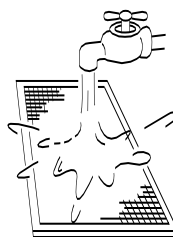

Fig. 2

- The air-in side should face up when using vacuum cleaner. (See Fig. 1)
- The air-in side should face down when using water. (See Fig. 2)

Cautions : Do not dry out the air filter under direct sunshine or with fire.

5. Re-install the air filter

6. Install and close the air-in grill in the reverse order of step 1 and 2 and connect the control box cables to the corresponding terminators of the main body .

Note: High-static Pressure Parvis Split Type has no air filter.

AIR CONDITIONER OPERATIONS AND PERFORMANCE

Three-minute protection feature

A protection feature prevents the air conditioner from being activated for approximately 3 minutes when it restarts immediately after operation.

Power failure

Power failure during operation will stop the unit completely.

- The OPERATION lamp on the indoor unit will start flashing when power is restored.
- To restart operation, push the ON/OFF button on the remote controller.
- Lightning or a car wireless telephone operating nearby may cause the unit to malfunction.

Disconnect the unit with the power and then connect the unit with the power again. Push the ON/OFF button on the remote controller to restart operation.

Air conditioner operating conditions

For proper performance, run the air conditioner under the following temperature conditions:

Mode	Cooling operation	Heating operation	Drying operation
Room temperature	17°C~32°C (62°F~90°F)	0°C~30°C (32°F~86°F)	17°C~ 32°C/ 62°F~ 90°F
Outdoor temperature	18°C~43°C (64°F~109°F)	-7°C~24°C (20°F~76°F)	18°C~ 43°C/64°F~109°F
	(-7°C~43°C/20°F~109°F: For the models with low temperature cooling system)		
	18°C~52°C/64°F~126°F: For special tropical models		18°C~52°C/64°F~126°F (For special tropical models)

NOTE:

1. If air conditioner is used outside of the above conditions, certain safety protection features may come into operation and cause the unit to function abnormally.
2. Room relative humidity less than 80%. If the air conditioner operates in excess of this figure, the surface of the air conditioner may attract condensation. Please sets the vertical air flow louver to its maximum angle (vertically to the floor), and set HIGH fan mode.
3. Optimum performance will be achieved within these operating temperature.

Special functions

Refrigerant Leakage Detection(optional):

With this new technology, the display area will appear EC (if applicable) and the LED indication lamps continue flashing when the outdoor unit detects refrigerant leakage.

Louver Angle Memory Function(optional):

For some models, the machine is special designed with louver angle memory function. Power failure during operation or pressing the ON/OFF button on the remote controller will stop the unit completely. When the power restores or pressing the ON/OFF button on the remote controller again, the unit restarts automatically with the previous open angle of the horizontal louver by the memory function. So we strongly recommend that the open angle of the horizontal louver should not be set too small, in case the condensed water forms and drops from the horizontal louver. Press the Manual control button and the open angle of the horizontal louver will be restored to the standard angle.

INSTALLATION

Location:

- During cooling operation, the air conditioner will dry the room air, so please fix a pipe to drain all the water away from the air conditioner.
- Please let the indoor unit more than one metre away from the TV set and the radio in order to avoid the picture and noise interference.
- Powerful radio transmitters or any other devices radiating high frequency radio waves can cause the air conditioner to malfunction. Please consult the dealer where you purchased the air conditioner before installing it.
- Don't fix the unit in the dangerous region with combustible gas or volatile matter.
- If the air conditioner operates in an atmosphere containing oils (machine oil), salt (near a coastal area), sulfide gas (near a hot spring), etc., such substances may lead to failure of the air conditioner.

Be careful of noise or vibrations

- Please fix the unit in the stable place to avoid the noise or vibrations.
- The noise near the air outlet of the outdoor unit may enter the air exit.
- Locate the outdoor unit where noise emitted by it or hot air from its air outlet will cause no nuisance to your neighbours.
- If the air conditioner sounds abnormal during operation, contact the dealer where you purchased the air conditioner.

Wire

- To avoid the electric shock, please link the air conditioner with the ground. The plug in the air conditioner has joined the ground wiring, please don't change it freely.
- The power socket is used as the air conditioner specially.
- Don't pull the power wiring hard.
- When linking the air conditioner with the ground, observe the local rulers.
- If necessary, use the power fuse or the circuit, breaker or the corresponding scale ampere.
If you want to change the power wiring, please contact the centre service of the local MD electric appliance.

Relocation

If you move out or if it is desired to relocate the air conditioner, consult your dealer, because special skills to withdraw Freon, purge air and perform other operations are required.

TROUBLES AND CAUSES

Before you ask for servicing or repairs, check the following points.

Recheck

Inoperative

- The power fuse is blown or the circuit breaker has been tripped.
- The batteries in the remote controller are exhausted.
- The timer is set.

Does not cool or heat well.

- The air inlet or outlet of the outdoor unit is blocked.
- Doors or windows are open.
- The air filter is clogged with dust.
- The louver is not at the correct position.
- The fan speed is set to low.
- The temperature setting is too high or too low.

These are not failures

Room air is smelly.

A bad odor comes from the air conditioner.

- Smells impregnated in the wall, carpet, furniture, clothing, or furs, are coming out. A white mist of chilled air or water is generated from the outdoor unit.

CAUTION

If any of the following conditions occur, stop the air conditioner immediately, set to off the power switch, and contact the dealer:

- The indicator lamps flash rapidly (five times per second), you disconnect the unit with the power and then connect the unit with the power again after two or three minutes but the lamps still flash.
- Switch operations are erratic.
- The fuse is blown frequently or the circuit breaker is tripped frequently.
- Foreign matter or water has fallen inside the air conditioner.
- Any other unusual condition is observed.

TROUBLES AND CAUSES (CONCERNING REMOTE CONTROLLER)

Before you ask for servicing or repairs, check the following points.

Setting Change is Impossible		
Symptoms	Causes	Reason and Disposal
The fan speed can not be changed.	<ul style="list-style-type: none"> • Check whether the MODE indicated on the display is "AUTO" 	When the automatic mode is selected, the air conditioner automatically selects the fan speed.
	<ul style="list-style-type: none"> • Check whether the MODE indicated on the display is "DRY" 	When dry operation is selected, the air conditioner automatically select the fan speed. The fan speed can be selected during "COOL" and "FAN ONLY", and "HEAT"

The Transmission Indicator "▲" Never Comes On		
Symptoms	Causes	Reason and Disposal
The remote control signal is not transmitted even when the ON/OFF button is pushed.	<ul style="list-style-type: none"> • Check whether the batteries in the remote controller are exhausted. 	The remote control signal is not transmitted, because the power supply is off.

The Display Never Comes On		
Symptoms	Causes	Reason
The TEMP. indicator does not come on.	<ul style="list-style-type: none"> • Check whether the MODE indicated on the display is "FAN ONLY". FAN ONLY 	The temperature cannot be set during fan only operation.

The Display Goes Off		
Symptoms	Causes	Reason
The indication on the display disappears after a lapse of time.	<ul style="list-style-type: none"> • Check whether the timer operation has come to an end when the OFF TIMER is indicated on the display. 	The air conditioner operation stops since the set time elapsed.
The ON TIMER indicators go off after a lapse of certain time.	<ul style="list-style-type: none"> • Check whether the timer operation is started when the ON TIMER is indicated on the display. 	When the time set to start the air conditioner is reached, the air conditioner will automatically start and the appropriate indicator will go off.

The Signal Receiving Tone does Not Sound		
Symptoms	Causes	Disposal
No receiving tone sounds from the indoor unit even when the ON/OFF button is pushed.	<ul style="list-style-type: none"> • Check whether the signal transmitter of the remote controller is properly directed to the receiver of the indoor unit when the ON/OFF button is pushed. 	Direct the signal transmitter of the remote controller to the receiver of the indoor unit, and then repeatedly push the ON/OFF button twice.
Buttons on the remote controller don't work.		Press Reset button.

The following displays indicate an error or problem:

NO	Malfunction	Display (nixie tube)	timer lamp	running lamp (flashes per second)
1	Indoor EEPROM error	E0.	OFF	1
2	Communication malfunction between indoor and outdoor units	E1.	OFF	2
3	Indoor fan speed malfunction	E3.	OFF	4
4	Indoor room temperature sensor open circuit or short circuit	E4.	OFF	5
5	Evaporator coil temperature sensor open circuit or short circuit	E5.	OFF	6
6	Refrigerant leakage detection malfunction	EC.	OFF	7
7	Water-level alarm malfunction	EE.	OFF	8
8	Communication malfunction between two indoor units (for twins model)	E8.	OFF	9
9	Other malfunction of twins model	E9.	OFF	10
10	Current overload protection	F0.	ON.	1
11	Outdoor room temperature sensor open circuit or short circuit	F1.	ON.	2
12	Outdoor condenser pipe temperature sensor error	F2.	ON.	3
13	Discharging air temperature sensor error	F3.	ON.	4
14	Outdoor EEPROM error	F4.	ON.	5
15	Outdoor fan speed malfunction (Only for DC fan motor)	F5.	ON.	6
16	T2b sensor error	F6.	ON.	7
17	Lifting panel communication checking channel is abnormal	F7.	ON.	8
18	Lifting panel malfunction	F8.	ON.	9
19	Lifting panel is not closed	F9.	ON.	10
20	Inverter module IPM protection	P0.	Flash.	1
21	High/Low voltage protection	P1.	Flash.	2
22	High temperature protection of compressor top	P2.	Flash.	3
23	Outdoor low temp. Protection	P3.	Flash.	4
24	Compressor drive error	P4.	Flash.	5
25	Mode conflict	P5.	Flash.	6

The displayed error code differs from appliance to appliance. The actual display of the indoor unit shall prevail.



The Klimaïre logo is a registered Trademark of Klimaïre Products inc.
Copyright 2016 Klimaïre Products inc.

2190 NW 89 Place, Doral, FL 33172 - USA

Tel: (305)594-4972 Fax (305) 499 4378
www.klimaïre.com sales@klimaïre.com