

Service Manual

Multi-Split Type Air Conditioners 2/3/4MXS-N Series

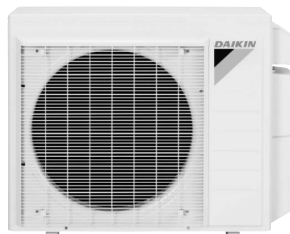

[Applied Models]

- Inverter Multi : Heat Pump

Multi-Split Type Air Conditioners 2/3/4MXS-N Series

●Heat Pump

Indoor Unit

CTXG09QVJUW	FDXS09LVJU	FVXS09NVJU	FFQ09Q2VJU
CTXG09QVJUS	FDXS12LVJU	FVXS12NVJU	FFQ12Q2VJU
CTXG12QVJUW	CDXS15LVJU	FVXS15NVJU	FFQ15Q2VJU
CTXG12QVJUS	CDXS18LVJU	FVXS18NVJU	FFQ18Q2VJU
CTXG18QVJUW	CDXS24LVJU		
CTXG18QVJUS			

CTXS07LVJU
FTXS09LVJU
FTXS12LVJU
FTXS15LVJU
FTXS18LVJU
FTXS24LVJU

Outdoor Unit

2MXS18NMVJU
3MXS24NMVJU
4MXS36NMVJU

1. Safety Cautions.....	vi
1.1 Warnings and Cautions Regarding Safety of Workers.....	vi
1.2 Warnings and Cautions Regarding Safety of Users.....	viii
2. Icons Used	xi
Part 1 List of Functions	1
1. Functions.....	2
Part 2 Specifications	8
1. Indoor Unit.....	9
1.1 CTXG Series	9
1.2 CTXS, FTXS Series	11
1.3 FDXS, CDXS Series.....	13
1.4 FVXS Series.....	15
1.5 FFQ Series	16
2. Outdoor Unit.....	17
Part 3 Printed Circuit Board Connector Wiring Diagram	20
1. Indoor Unit.....	21
1.1 CTXG09/12/18QVJUW(S).....	21
1.2 CTXS07LVJU, FTXS09/12LVJU	23
1.3 FTXS15/18/24LVJU	25
1.4 FDXS09/12LVJU, CDXS15/18/24LVJU	27
1.5 FVXS09/12/15/18NVJU.....	29
1.6 FFQ09/12/15/18Q2VJU.....	31
2. Wired Remote Controller.....	32
2.1 BRC1E73	32
3. Wireless Remote Controller Kit	33
3.1 BRC082A41W, BRC082A42W(S).....	33
4. Outdoor Unit.....	34
Part 4 Functions and Control.....	37
1. Common Functions	39
1.1 Temperature Control	39
1.2 Frequency Principle.....	39
2. CTXG, CTXS, FTXS, CDXS, FDXS, FVXS Series Functions.....	41
2.1 Airflow Direction Control.....	41
2.2 Fan Speed Control for Indoor Unit	45
2.3 Program Dry Operation	46
2.4 Automatic Operation.....	47
2.5 Thermostat Control.....	48
2.6 NIGHT SET Mode	49
2.7 ECONO Operation	50
2.8 2-Area INTELLIGENT EYE Operation	51
2.9 INTELLIGENT EYE Operation	53

2.10	POWERFUL Operation	54
2.11	Multi-Monitor Lamp/TIMER Lamp	55
2.12	Clock Setting	56
2.13	WEEKLY TIMER Operation	57
2.14	Other Functions.....	63
3.	FFQ Series Functions	65
3.1	Airflow Direction Control.....	65
3.2	Fan Speed Control for Indoor Unit	65
3.3	Program Dry Operation	66
3.4	Clock and Calendar Setting (With Wired Remote Controller BRC1E73)	67
3.5	Schedule TIMER Operation (With Wired Remote Controller BRC1E73)	69
3.6	Setback Function (With Wired Remote Controller BRC1E73)	73
3.7	Drain Pump Control.....	73
3.8	Hot Start Control (In Heating Operation Only).....	75
3.9	Presence and Floor Sensors (Option).....	76
3.10	Other Functions.....	79
4.	Control Specification	80
4.1	Thermistor Functions.....	80
4.2	Mode Hierarchy	82
4.3	Frequency Control.....	83
4.4	Controls at Mode Changing/Start-up.....	85
4.5	Discharge Pipe Temperature Control.....	86
4.6	Input Current Control.....	87
4.7	Freeze-up Protection Control	88
4.8	Heating Peak-cut Control	88
4.9	Outdoor Fan Control.....	89
4.10	Liquid Compression Protection Function.....	89
4.11	Defrost Control	90
4.12	Low Hz High Pressure Limit.....	91
4.13	Electronic Expansion Valve Control	92
4.14	Malfunctions	97

Part 5 Remote Controller 98

1.	Applicable Remote Controller	99
2.	ARC466A36	100
3.	ARC452A21	102
4.	ARC452A23	104
5.	ARC466A21	106
6.	BRC1E73 (Wired Remote Controller)	108
7.	BRC082A41W, BRC082A42W(S) (Wireless Remote Controller Kit).....	114

Part 6 Service Diagnosis..... 116

1.	General Problem Symptoms and Check Items	118
2.	Troubleshooting with LED	119

2.1	Indoor Unit.....	119
2.2	Outdoor Unit.....	121
3.	Service Diagnosis	122
3.1	CTXG, CTXS, FTXS, CDXS, FDXS, FVXS Series	122
3.2	FFQ Series.....	128
4.	Code Indication on Remote Controller	134
4.1	CTXG, CTXS, FTXS, CDXS, FDXS, FVXS Series	134
4.2	FFQ Series.....	134
4.3	Outdoor Unit.....	135
5.	Troubleshooting for CTXG, CTXS, FTXS, CDXS, FDXS, FVXS Series.....	136
5.1	Indoor Unit PCB Abnormality	136
5.2	Freeze-up Protection Control/Heating Peak-cut Control.....	138
5.3	Indoor Fan Motor or Related Abnormality	139
5.4	Thermistor or Related Abnormality.....	143
5.5	Front Panel Open/Close Fault.....	144
5.6	Signal Transmission Error (Between Indoor Unit and Outdoor Unit).....	145
5.7	Mismatching of Indoor Unit and Outdoor Unit	147
6.	Troubleshooting for FFQ Series	148
6.1	Indoor Unit PCB Abnormality	148
6.2	Drain Level Control System Abnormality.....	149
6.3	Indoor Fan Motor (DC Motor) or Related Abnormality	150
6.4	Humidifier or Related Abnormality.....	152
6.5	Thermistor or Related Abnormality.....	153
6.6	Presence Sensor or Floor Sensor Abnormality	154
6.7	Remote Controller Thermistor Abnormality	155
6.8	Signal Transmission Error (Between Indoor Unit and Outdoor Unit).....	156
6.9	Signal Transmission Error (Between Indoor Unit and Remote Controller)	158
6.10	Signal Transmission Error (Between MAIN Remote Controller and SUB Remote Controller)	159
6.11	Mismatching of Indoor Unit and Outdoor Unit	160
7.	Troubleshooting for Outdoor Unit.....	161
7.1	Refrigerant Shortage	161
7.2	Low-voltage Detection or Over-voltage Detection.....	163
7.3	Wiring Error Check Unexecuted.....	165
7.4	Unspecified Voltage (Between Indoor Unit and Outdoor Unit)/ Anti-icing Control in Other Rooms.....	166
7.5	Anti-icing Control for Indoor Unit	167
7.6	Outdoor Unit PCB Abnormality.....	169
7.7	OL Activation (Compressor Overload)	170
7.8	Compressor Lock	172
7.9	DC Fan Lock	173
7.10	Input Overcurrent Detection	174
7.11	Four Way Valve Abnormality.....	175
7.12	Discharge Pipe Temperature Control.....	177
7.13	High Pressure Control in Cooling	178
7.14	Compressor Sensor System Abnormality	179

7.15	Position Sensor Abnormality	181
7.16	CT or Related Abnormality	183
7.17	Thermistor or Related Abnormality (Outdoor Unit)	185
7.18	Electrical Box Temperature Rise	187
7.19	Radiation Fin Temperature Rise	188
7.20	Output Overcurrent Detection	189
8.	Check	191
8.1	Thermistor Resistance Check	191
8.2	Indoor Fan Motor Connector Check	192
8.3	Hall IC Check	192
8.4	Power Supply Waveform Check	193
8.5	Electronic Expansion Valve Check	194
8.6	Four Way Valve Performance Check	195
8.7	Inverter Unit Refrigerant System Check	195
8.8	Inverter Analyzer Check	196
8.9	Rotation Pulse Check on the Outdoor Unit PCB	197
8.10	Installation Condition Check	198
8.11	Discharge Pressure Check	198
8.12	Outdoor Fan System Check	199
8.13	Main Circuit Short Check	199
8.14	Capacitor Voltage Check	200
8.15	Power Module Check	201

Part 7 Trial Operation and Field Settings..... 202

1.	Pump Down Operation	203
2.	Forced Cooling Operation	204
3.	Wiring Error Check Function	205
4.	Trial Operation	207
4.1	CTXG, CTXS, FTXS, CDXS, FDXS, FVXS Series	207
4.2	FFQ Series	209
5.	Field Settings	212
5.1	Outdoor Unit	212
5.2	CTXG, CTXS, FTXS, CDXS, FDXS, FVXS Series	214
5.3	FFQ Series	219
6.	Silicone Grease on Power Transistor/Diode Bridge	227





Part 8 Appendix..... 228

1.	Piping Diagrams	229
1.1	Indoor Unit	229
1.2	Outdoor Unit	232
2.	Wiring Diagrams	234
2.1	Indoor Unit	234
2.2	Outdoor Unit	240
3.	Operation Limit	243



1. Safety Cautions

Be sure to read the following safety cautions before conducting repair work. After the repair work is complete, be sure to conduct a test operation to ensure that the equipment operates normally, and explain the cautions for operating the product to the customer.







Caution Items





The caution items are classified into  **Warning** and  **Caution**. The  **Warning** items are especially important since death or serious injury can result if they are not followed closely. The  **Caution** items can also lead to serious accidents under some conditions if they are not followed. Therefore, be sure to observe all the safety caution items described below.







Pictograms



-  This symbol indicates an item for which caution must be exercised. The pictogram shows the item to which attention must be paid.
-  This symbol indicates a prohibited action. The prohibited item or action is shown in the illustration or near the symbol.
-  This symbol indicates an action that must be taken, or an instruction. The instruction is shown in the illustration or near the symbol.

1.1 Warnings and Cautions Regarding Safety of Workers









 Warning	
Do not store equipment in a room with fire sources (e.g., naked flames, gas appliances, electric heaters).	
Be sure to disconnect the power cable from the socket before disassembling equipment for repair. Working on equipment that is connected to the power supply may cause an electrical shock. If it is necessary to supply power to the equipment to conduct the repair or inspect the circuits, do not touch any electrically charged sections of the equipment.	
If refrigerant gas is discharged during repair work, do not touch the discharged refrigerant gas. Refrigerant gas may cause frostbite.	
When disconnecting the suction or discharge pipe of the compressor at the welded section, evacuate the refrigerant gas completely at a well-ventilated place first. If there is gas remaining inside the compressor, the refrigerant gas or refrigerating machine oil discharges when the pipe is disconnected, and it may cause injury.	
If refrigerant gas leaks during repair work, ventilate the area. Refrigerant gas may generate toxic gases when it contacts flames.	
Be sure to discharge the capacitor completely before conducting repair work. The step-up capacitor supplies high-voltage electricity to the electrical components of the outdoor unit. A charged capacitor may cause an electrical shock.	







 Warning	
<p>Do not turn the air conditioner on or off by plugging in or unplugging the power cable. Plugging in or unplugging the power cable to operate the equipment may cause an electrical shock or fire.</p>	
<p>Be sure to wear a safety helmet, gloves, and a safety belt when working in a high place (more than 2 m (6.5 ft)). Insufficient safety measures may cause a fall.</p>	
<p>In case of R-32 / R-410A refrigerant models, be sure to use pipes, flare nuts and tools intended for the exclusive use with the R-32 / R-410A refrigerant. The use of materials for R-22 refrigerant models may cause a serious accident, such as a damage of refrigerant cycle or equipment failure.</p>	
<p>Do not mix air or gas other than the specified refrigerant (R-32 / R-410A / R-22) in the refrigerant system. If air enters the refrigerant system, an excessively high pressure results, causing equipment damage and injury.</p>	





 Caution	
<p>Do not repair electrical components with wet hands. Working on the equipment with wet hands may cause an electrical shock.</p>	
<p>Do not clean the air conditioner with water. Washing the unit with water may cause an electrical shock.</p>	
<p>Be sure to provide an earth / grounding when repairing the equipment in a humid or wet place, to avoid electrical shocks.</p>	
<p>Be sure to turn off the power switch and unplug the power cable when cleaning the equipment. The internal fan rotates at a high speed, and may cause injury.</p>	
<p>Be sure to conduct repair work with appropriate tools. The use of inappropriate tools may cause injury.</p>	
<p>Be sure to check that the refrigerating cycle section has cooled down enough before conducting repair work. Working on the unit when the refrigerating cycle section is hot may cause burns.</p>	





 Caution	
Conduct welding work in a well-ventilated place. Using a welder in an enclosed room may cause oxygen deficiency.	

1.2 Warnings and Cautions Regarding Safety of Users

 Warning	
Do not store the equipment in a room with fire sources (e.g., naked flames, gas appliances, electric heaters).	
Be sure to use parts listed in the service parts list of the applicable model and appropriate tools to conduct repair work. Never attempt to modify the equipment. The use of inappropriate parts or tools may cause an electrical shock, excessive heat generation or fire.	
If the power cable and lead wires are scratched or have deteriorated, be sure to replace them. Damaged cable and wires may cause an electrical shock, excessive heat generation or fire.	
Do not use a joined power cable or extension cable, or share the same power outlet with other electrical appliances, since it may cause an electrical shock, excessive heat generation or fire.	
Be sure to use an exclusive power circuit for the equipment, and follow the local technical standards related to the electrical equipment, the internal wiring regulations, and the instruction manual for installation when conducting electrical work. Insufficient power circuit capacity and improper electrical work may cause an electrical shock or fire.	
Be sure to use the specified cable for wiring between the indoor and outdoor units. Make the connections securely and route the cable properly so that there is no force pulling the cable at the connection terminals. Improper connections may cause excessive heat generation or fire.	
When wiring between the indoor and outdoor units, make sure that the terminal cover does not lift off or dismount because of the cable. If the cover is not mounted properly, the terminal connection section may cause an electrical shock, excessive heat generation or fire.	
Do not damage or modify the power cable. Damaged or modified power cables may cause an electrical shock or fire. Placing heavy items on the power cable, or heating or pulling the power cable may damage it.	





 Warning	
<p>Do not mix air or gas other than the specified refrigerant (R-32 / R-410A / R-22) in the refrigerant system. If air enters the refrigerant system, an excessively high pressure results, causing equipment damage and injury.</p>	
<p>If the refrigerant gas leaks, be sure to locate the leaking point and repair it before charging the refrigerant. After charging the refrigerant, make sure that there is no leak. If the leaking point cannot be located and the repair work must be stopped, be sure to pump-down, and close the service valve, to prevent refrigerant gas from leaking into the room. Refrigerant gas itself is harmless, but it may generate toxic gases when it contacts flames, such as those from fan type and other heaters, stoves and ranges.</p>	
<p>When relocating the equipment, make sure that the new installation site has sufficient strength to withstand the weight of the equipment. If the installation site does not have sufficient strength or the installation work is not conducted securely, the equipment may fall and cause injury.</p>	
<p>Check to make sure that the power cable plug is not dirty or loose, then insert the plug into a power outlet securely. If the plug is dusty or has a loose connection, it may cause an electrical shock or fire.</p>	
<p>When replacing the coin battery in the remote controller, be sure to dispose of the old battery to prevent children from swallowing it. If a child swallows the coin battery, see a doctor immediately.</p>	

 Caution	
<p>Installation of a leakage breaker is necessary in some cases depending on the conditions of the installation site, to prevent electrical shocks.</p>	
<p>Do not install the equipment in a place where there is a possibility of combustible gas leaks. If combustible gas leaks and remains around the unit, it may cause a fire.</p>	
<p>Check to see if parts and wires are mounted and connected properly, and if connections at the soldered or crimped terminals are secure. Improper installation and connections may cause excessive heat generation, fire or an electrical shock.</p>	
<p>If the installation platform or frame has corroded, replace it. A corroded installation platform or frame may cause the unit to fall, resulting in injury.</p>	

 Caution	
<p>Check the earth / grounding, and repair it if the equipment is not properly earthed / grounded. Improper earth / grounding may cause an electrical shock.</p>	
<p>Be sure to measure insulation resistance after the repair, and make sure that the resistance is 1 MΩ or higher. Faulty insulation may cause an electrical shock.</p>	
<p>Be sure to check the drainage of the indoor unit after the repair. Faulty drainage may cause water to enter the room and wet the furniture and floor.</p>	
<p>Do not tilt the unit when removing it. The water inside the unit may spill and wet the furniture and floor.</p>	

2. Icons Used

The following icons are used to attract the attention of the reader to specific information.

Icon	Type of Information	Description
 Warning	Warning	A Warning is used when there is danger of personal injury.
 Caution	Caution	A Caution is used when there is danger that the reader, through incorrect manipulation, may damage equipment, lose data, get an unexpected result or have to restart (part of) a procedure.
 Note:	Note	A Note provides information that is not indispensable, but may nevertheless be valuable to the reader, such as tips and tricks.
	Reference	A Reference guides the reader to other places in this binder or in this manual, where he/she will find additional information on a specific topic.

Part 1

List of Functions

1. Functions.....2

1. Functions

Category	Functions	CTXG09/12/18QVJUW(S)	Category	Functions	CTXG09/12/18QVJUW(S)
Basic Functions	Inverter (with inverter power control)	●	Health & Cleanliness	Air-purifying filter	—
	Operation limit for cooling	—		Titanium apatite deodorizing filter (option)	●
	Operation limit for heating	—		Longlife filter (option)	—
	PAM control	—		Air filter (prefilter)	●
Compressor	Oval scroll compressor	—		Wipe-clean flat panel	●
	Swing compressor	—		Washable grille	—
	Rotary compressor	—		Filter cleaning indicator	—
	Reluctance DC motor	—		Good-sleep cooling operation	—
Comfortable Airflow	Power-airflow flap (horizontal blade)	—	Timer	WEEKLY TIMER operation	●
	Power-airflow dual flaps (horizontal blade)	●		24-hour ON/OFF timer	●
	Power-airflow diffuser	—		NIGHT SET mode	●
	Wide-angle louvers (vertical blades)	●	Worry Free (Reliability & Durability)	Auto-restart (after power failure)	●
	Auto-swing (up and down)	●		Self-diagnosis (R/C, LED)	●
	Auto-swing (right and left)	●		Wiring error check function	—
	3-D airflow	●		Anti-corrosion treatment of outdoor heat exchanger	—
	COMFORT AIRFLOW operation	●			
Comfort Control	Auto fan speed	●	Flexibility	Multi-split/split type compatible indoor unit	—
	Indoor unit quiet operation	●		Flexible power supply correspondence	—
	NIGHT QUIET mode (automatic)	—		High ceiling application	—
	OUTDOOR UNIT QUIET operation (manual)	●		Chargeless	—
	INTELLIGENT EYE operation	—		Either side drain (right or left)	●
	2-area INTELLIGENT EYE operation	●		Power selection	—
	Quick warming function	—		°F/°C changeover R/C temperature display (factory setting: °F)	●
	Hot-start function	●			
	Automatic defrosting	—		Remote Control	Remote control adaptor (normal open pulse contact) (option)
Operation	Automatic operation	●	Remote control adaptor (normal open contact) (option)		●
	Program dry operation	●	DIII-NET compatible (adaptor) (option)		●
	Fan only	●	Wireless LAN connection (option)	●	
Lifestyle Convenience	POWERFUL operation (non-inverter)	—	Remote Controller	Wireless	●
	POWERFUL operation (inverter)	●		Wired (option)	●
	Priority-room setting	—			
	COOL/HEAT mode lock	—			
	HOME LEAVE operation	—			
	ECONO operation	●			
	Indoor unit ON/OFF button	●			
	Signal receiving sign	●			
	R/C with back light	●			
	Temperature display	—			

Note: ● : Available
 — : Not Available

Category	Functions			Category	Functions			
		CTXS07LVJU	FTXS09/12/15/18/24LVJU			CTXS07LVJU	FTXS09/12/15/18/24LVJU	
Basic Functions	Inverter (with inverter power control)	●	●	Health & Cleanliness	Air-purifying filter	—	—	
	Operation limit for cooling	—	—		Titanium apatite deodorizing filter	●	●	
	Operation limit for heating	—	—		Longlife filter (option)	—	—	
	PAM control	—	—		Air filter (prefilter)	●	●	
Compressor	Oval scroll compressor	—	—		Wipe-clean flat panel	●	●	
	Swing compressor	—	—		Washable grille	—	—	
	Rotary compressor	—	—		Filter cleaning indicator	—	—	
	Reluctance DC motor	—	—		Good-sleep cooling operation	—	—	
Comfortable Airflow	Power-airflow flap (horizontal blade)	—	—		Timer	WEEKLY TIMER operation	●	●
	Power-airflow dual flaps (horizontal blade)	●	●			24-hour ON/OFF TIMER	●	●
	Power-airflow diffuser	—	—	NIGHT SET mode		●	●	
	Wide-angle louvers (vertical blades)	●	●	Worry Free (Reliability & Durability)	Auto-restart (after power failure)	●	●	
	Auto-swing (up and down)	●	●		Self-diagnosis (R/C, LED)	●	●	
	Auto-swing (right and left)	●	●		Wiring error check function	—	—	
	3-D airflow	●	●		Anti-corrosion treatment of outdoor heat exchanger	—	—	
	COMFORT AIRFLOW operation	●	●	Flexibility	Multi-split/split type compatible indoor unit	—	●	
Comfort Control	Auto fan speed	●	●		Flexible power supply correspondence	—	—	
	Indoor unit quiet operation	●	●		High ceiling application	—	—	
	NIGHT QUIET mode (automatic)	—	—		Chargeless	—	—	
	OUTDOOR UNIT QUIET operation (manual)	●	●		Either side drain (right or left)	●	●	
	INTELLIGENT EYE operation	●	●		Power selection	—	—	
	2-area INTELLIGENT EYE operation	—	—		°F/°C changeover R/C temperature display (factory setting: °F)	●	●	
	Quick warming function	—	—		Remote Control	Remote control adaptor (normal open pulse contact) (option)	●	●
	Hot-start function	●	●	Remote control adaptor (normal open contact) (option)		●	●	
Automatic defrosting	—	—	DIII-NET compatible (adaptor) (option)	●		●		
Operation	Automatic operation	●	●	Wireless LAN connection (option)		—	—	
	Program dry function	●	●	Remote Controller	Wireless	●	●	
	Fan only	●	●		Wired (option)	●	●	
Lifestyle Convenience	POWERFUL operation (non-inverter)	—	—					
	POWERFUL operation (inverter)	●	●					
	Priority-room setting	—	—					
	COOL/HEAT mode lock	—	—					
	HOME LEAVE operation	—	—					
	ECONO operation	●	●					
	Indoor unit ON/OFF button	●	●					
	Signal receiving sign	●	●					
	R/C with back light	●	●					
Temperature display	—	—						

Note: ● : Available
— : Not available

Category	Functions	FDXS09/12LVJU	CDXS15/18/24LVJU	Category	Functions	FDXS09/12LVJU	CDXS15/18/24LVJU	
Basic Functions	Inverter (with inverter power control)	●	●	Health & Cleanliness	Air-purifying filter	—	—	
	Operation limit for cooling	—	—		Titanium apatite deodorizing filter	—	—	
	Operation limit for heating	—	—		Longlife filter (option)	—	—	
	PAM control	—	—		Air filter (prefilter)	●	●	
Compressor	Oval scroll compressor	—	—		Wipe-clean flat panel	—	—	
	Swing compressor	—	—		Washable grille	—	—	
	Rotary compressor	—	—		Filter cleaning indicator	—	—	
	Reluctance DC motor	—	—		Good-sleep cooling operation	—	—	
Comfortable Airflow	Power-airflow flap (horizontal blade)	—	—		Timer	WEEKLY TIMER operation	—	—
	Power-airflow dual flaps (horizontal blade)	—	—			24-hour ON/OFF TIMER	●	●
	Power-airflow diffuser	—	—			NIGHT SET mode	●	●
	Wide-angle louvers (vertical blades)	—	—		Worry Free (Reliability & Durability)	Auto-restart (after power failure)	●	●
	Auto-swing (up and down)	—	—	Self-diagnosis (R/C, LED)		●	●	
	Auto-swing (right and left)	—	—	Wiring error check function		—	—	
	3-D airflow	—	—	Anti-corrosion treatment of outdoor heat exchanger		—	—	
	COMFORT AIRFLOW operation	—	—	Flexibility	Multi-split/split type compatible indoor unit	●	—	
Comfort Control	Auto fan speed	●	●		Flexible power supply correspondence	—	—	
	Indoor unit quiet operation	●	●		High ceiling application	—	—	
	NIGHT QUIET mode (automatic)	—	—		Chargeless	—	—	
	OUTDOOR UNIT QUIET operation (manual)	●	●		Either side drain (right or left)	—	—	
	INTELLIGENT EYE operation	—	—		Power selection	—	—	
	2-area INTELLIGENT EYE operation	—	—		°F/°C changeover R/C temperature display (factory setting: °F)	●	●	
	Quick warming function	—	—		Remote Control	Remote control adaptor (normal open pulse contact) (option)	●	●
	Hot-start function	●	●	Remote control adaptor (normal open contact) (option)		●	●	
Automatic defrosting	—	—	DIII-NET compatible (adaptor) (option)	●		●		
Operation	Automatic operation	●	●	Wireless LAN connection (option)		—	—	
	Program dry function	●	●	Remote Controller	Wireless (option)	●	●	
	Fan only	●	●		Wired (option)	●	●	
Lifestyle Convenience	POWERFUL operation (non-inverter)	—	—					
	POWERFUL operation (inverter)	●	●					
	Priority-room setting	—	—					
	COOL/HEAT mode lock	—	—					
	HOME LEAVE operation	—	—					
	ECONO operation	●	●					
	Indoor unit ON/OFF button	●	●					
	Signal receiving sign	●	●					
	R/C with back light	●	●					
Temperature display	—	—						

Note: ● : Available
 — : Not available

Category	Functions	FVXS09/12/15/18NVJU	Category	Functions	FVXS09/12/15/18NVJU	
Basic Functions	Inverter (with inverter power control)	●	Health & Cleanliness	Air-purifying filter	—	
	Operation limit for cooling	—		Titanium apatite deodorizing filter	●	
	Operation limit for heating	—		Longlife filter (option)	—	
	PAM control	—		Air filter (prefilter)	●	
Compressor	Oval scroll compressor	—		Wipe-clean flat panel	●	
	Swing compressor	—		Washable grille	—	
	Rotary compressor	—		Filter cleaning indicator	—	
	Reluctance DC motor	—		Good-sleep cooling operation	—	
Comfortable Airflow	Power-airflow flap (horizontal blade)	●		Timer	WEEKLY TIMER operation	●
	Power-airflow dual flaps (horizontal blade)	—			24-hour ON/OFF TIMER	●
	Power-airflow diffuser	—			NIGHT SET mode	●
	Wide-angle louvers (vertical blades)	●		Worry Free (Reliability & Durability)	Auto-restart (after power failure)	●
	Auto-swing (up and down)	●	Self-diagnosis (R/C, LED)		●	
	Auto-swing (right and left)	—	Wiring error check function		—	
	3-D airflow	—	Anti-corrosion treatment of outdoor heat exchanger		—	
	COMFORT AIRFLOW operation	—				
Comfort Control	Auto fan speed	●	Flexibility	Multi-split/split type compatible indoor unit	—	
	Indoor unit quiet operation	●		Flexible power supply correspondence	—	
	NIGHT QUIET mode (automatic)	—		High ceiling application	—	
	OUTDOOR UNIT QUIET operation (manual)	●		Chargeless	—	
	INTELLIGENT EYE operation	—		Either side drain (right or left)	—	
	2-area INTELLIGENT EYE operation	—		Power selection	—	
	Quick warming function	—		°F/°C changeover R/C temperature display (factory setting: °F)	●	
	Hot-start function	●				
	Automatic defrosting	—	Remote Control	Remote control adaptor (normal open pulse contact) (option)	●	
Operation	Automatic operation	●		Remote control adaptor (normal open contact) (option)	●	
	Program dry function	●		DIII-NET compatible (adaptor) (option)	●	
	Fan only	●	Wireless LAN connection (option)	—		
Lifestyle Convenience	POWERFUL operation (non-inverter)	—	Remote Controller	Wireless	●	
	POWERFUL operation (inverter)	●		Wired (option)	—	
	Priority-room setting	—				
	COOL/HEAT mode lock	—				
	HOME LEAVE operation	—				
	ECONO operation	●				
	Indoor unit ON/OFF button	●				
	Signal receiving sign	●				
	R/C with back light	●				
	Temperature display	—				

Note: ● : Available
 — : Not available

Category	Functions	FFQ09/12/15/18Q2VJU with BYFQ60B3W1	FFQ09/12/15/18Q2VJU with BYFQ60C2W1W(S)	Category	Functions	FFQ09/12/15/18Q2VJU with BYFQ60B3W1	FFQ09/12/15/18Q2VJU with BYFQ60C2W1W(S)
Basic Functions	Inverter (with inverter power control)	●	●	Health & Cleanliness	Auto cleaning filter	—	—
	Operation limit for cooling	—	—		Air-purifying filter	—	—
	Operation limit for heating	—	—		Titanium apatite deodorizing filter	—	—
	PAM control	—	—		Longlife filter	●	●
	Standby electricity saving	—	—		Air filter	—	—
Compressor	Oval scroll compressor	—	—		Filter cleaning indicator	●	●
	Swing compressor	—	—		Wipe-clean flat panel	—	—
	Rotary compressor	—	—		Washable grille	●	●
	Reluctance DC motor	—	—		MOLD PROOF operation	—	—
Comfortable Airflow	Power-airflow flap (horizontal blade)	—	—		Timer	Good-sleep cooling operation	—
	Power-airflow dual flaps (horizontal blade)	—	—	Schedule TIMER operation		●★1	●★1
	Power-airflow diffuser	—	—	72-hour ON/OFF TIMER		●★2	●★2
	Wide-angle louvers (vertical blades)	—	—	Off Timer (power off forget prevention)		●★1	●★1
	Auto-swing (up and down)	●	●	Worry Free (Reliability & Durability)	NIGHT SET mode	—	—
	Auto-swing (right and left)	—	—		Auto-restart (after power failure)	●	●
	Individual flap control	—	●★1		Self-diagnosis (R/C, LED)	●	●
	3-D airflow	—	—		Wiring error check function	—	—
COMFORT AIRFLOW operation	—	—	Anti-corrosion treatment of outdoor heat exchanger	—	—		
Comfort Control	Auto fan speed	●★1	●★1	Flexibility	Multi-split/split type compatible indoor unit	●	●
	Indoor unit quiet operation	—	—		H/P, C/O compatible indoor unit	—	—
	NIGHT QUIET mode (automatic)	—	—		Flexible power supply correspondence	—	—
	OUTDOOR UNIT QUIET operation (manual)	—	—		Chargeless	—	—
	Presence and floor sensor (option)	—	●★1		Either side drain (right or left)	—	—
	Hot-start function	●	●		Power selection	—	—
	Draft prevention with sensor	●	●		°F/°C changeover R/C temperature display (factory setting: °F)	●★1	●★1
	Automatic defrosting	●	●				
Operation	Automatic operation	●	●	Remote Control	Remote control adaptor (normal open pulse contact) (option)	—	—
	Program dry function	●	●		Remote control adaptor (normal open contact) (option)	—	—
	Fan only	●	●		DIII-NET compatible (adaptor) (option)	—	—
	Setback function	●★1	●★1	Remote Controller	Wireless (option)	●	●
Lifestyle Convenience	POWERFUL operation (non-inverter)	—	—		Wired (option)	●	●
	POWERFUL operation (inverter)	—	—				
	Priority-room setting	—	—				
	COOL/HEAT mode lock	—	—				
	HOME LEAVE operation	—	—				
	ECONO operation	—	—				
	Indoor unit ON/OFF button	—	—				
	Signal receiving sign	●★2 ★3	●★2 ★3				
R/C with back light	●★1	●★1					

Note: ● : Available
— : Not available

★1: With wired remote controller
★2: With wireless remote controller
★3: Receiving sound only

Category	Functions	2MXS18NMVJU	3MXS24NMVJU 4MXS36NMVJU	Category	Functions	2MXS18NMVJU	3MXS24NMVJU 4MXS36NMVJU	
Basic Functions	Inverter (with inverter power control)	●	●	Health & Cleanliness	Air-purifying filter	—	—	
	Operation limit for cooling	Refer to P. 243			Titanium apatite deodorizing filter	—	—	
	Operation limit for heating				Longlife filter (option)	—	—	
	PAM control	●	●		Air filter (prefilter)	—	—	
Compressor	Oval scroll compressor	—	—		Wipe-clean flat panel	—	—	
	Swing compressor	●	●		Washable grille	—	—	
	Rotary compressor	—	—		Filter cleaning indicator	—	—	
	Reluctance DC motor	●	●		Good-sleep cooling operation	—	—	
Comfortable Airflow	Power-airflow flap (horizontal blade)	—	—		Timer	WEEKLY TIMER operation	—	—
	Power-airflow dual flaps (horizontal blade)	—	—			24-hour ON/OFF timer	—	—
	Power-airflow diffuser	—	—	NIGHT SET mode		—	—	
	Wide-angle louvers (vertical blades)	—	—	Worry Free (Reliability & Durability)	Auto-restart (after power failure)	—	—	
	Auto-swing (up and down)	—	—		Self-diagnosis (R/C, LED)	●	●	
	Auto-swing (right and left)	—	—		Wiring error check function	●	●	
	3-D airflow	—	—		Anti-corrosion treatment of outdoor heat exchanger	●	●	
COMFORT AIRFLOW operation	—	—	Flexibility	Multi-split/split type compatible indoor unit	—	—		
Comfort Control	Auto fan speed	—		—	Flexible power supply correspondence	—	—	
	Indoor unit quiet operation	—		—	High ceiling application	—	—	
	NIGHT QUIET mode (automatic)	●		●	Chargeless	98.4 ft (30 m)	131.6 ft (40 m)	
	OUTDOOR UNIT QUIET operation (manual)	●		●	Either side drain (right or left)	—	—	
	INTELLIGENT EYE operation	—		—	Power selection	—	—	
	2-area INTELLIGENT EYE operation	—		—	°F/°C changeover R/C temperature display (factory setting: °F)	—	—	
	Quick warming function	●		●	Remote Control	Remote control adaptor (normal open pulse contact) (option)	—	—
	Hot-start function	—	—	Remote control adaptor (normal open contact) (option)		—	—	
Automatic defrosting	●	●	DIII-NET compatible (adaptor) (option)	—		—		
Operation	Automatic operation	—	—	Wireless LAN connection (option)		—	—	
	Program dry function	—	—	Remote Controller	Wireless	—	—	
	Fan only	—	—		Wired (option)	—	—	
	Lifestyle Convenience	POWERFUL operation (non-inverter)	—	—				
		POWERFUL operation (inverter)	—	—				
		Priority-room setting	●	●				
		COOL/HEAT mode lock	●	●				
		HOME LEAVE operation	—	—				
		ECONO operation	—	—				
Indoor unit ON/OFF button		—	—					
Signal receiving sign		—	—					
R/C with back light	—	—						
Temperature display	—	—						

Note: ● : Available
— : Not available

Part 2 Specifications

- 1. Indoor Unit..... 9
 - 1.1 CTXG Series 9
 - 1.2 CTXS, FTXS Series 11
 - 1.3 FDXS, CDXS Series..... 13
 - 1.4 FVXS Series..... 15
 - 1.5 FFQ Series 16
- 2. Outdoor Unit..... 17

1. Indoor Unit

1.1 CTXG Series

60 Hz, 208 - 230 V

Model			CTXG09QVJUW		CTXG09QVJUS	
			Cooling	Heating	Cooling	Heating
Rated Capacity			9 kBtu/h Class		9 kBtu/h Class	
Front Panel Color			White		Silver	
Airflow Rate	H	cfm (m ³ /min)	279 (7.9)	367 (10.4)	279 (7.9)	367 (10.4)
	M		212 (6.0)	265 (7.5)	212 (6.0)	265 (7.5)
	L		162 (4.6)	205 (5.8)	162 (4.6)	205 (5.8)
	SL		134 (3.8)	117 (3.3)	134 (3.8)	117 (3.3)
Fan	Type		Cross Flow Fan		Cross Flow Fan	
	Motor Output	W	29		29	
	Speed	Steps	5 Steps, Quiet, Auto		5 Steps, Quiet, Auto	
Air Direction Control			Right, Left, Horizontal, Downward		Right, Left, Horizontal, Downward	
Air Filter			Removable, Washable, Mildew Proof		Removable, Washable, Mildew Proof	
Running Current (Rated)		A	0.07 - 0.07	0.13 - 0.12	0.07 - 0.07	0.13 - 0.12
Power Consumption (Rated)		W	13 - 13	26 - 26	13 - 13	26 - 26
Power Factor (Rated)		%	89.2 - 80.7	96.2 - 94.2	89.2 - 80.7	96.2 - 94.2
Temperature Control			Microcomputer Control		Microcomputer Control	
Dimensions (H x W x D)		in. (mm)	11-15/16 x 39-5/16 x 8-3/8 (303 x 998 x 212)		11-15/16 x 39-5/16 x 8-3/8 (303 x 998 x 212)	
Packaged Dimensions (H x W x D)		in. (mm)	12-11/16 x 43-3/8 x 15-5/16 (322 x 1,101 x 389)		12-11/16 x 43-3/8 x 15-5/16 (322 x 1,101 x 389)	
Weight (Mass)		Lbs (kg)	27 (12)		27 (12)	
Gross Weight (Gross Mass)		Lbs (kg)	36 (16)		36 (16)	
Sound Pressure Level	H / M / L / SL	dB(A)	38 / 32 / 25 / 21	41 / 34 / 28 / 21	38 / 32 / 25 / 21	41 / 34 / 28 / 21
Sound Power Level		dB	—	—	—	—
Heat Insulation			Both Liquid and Gas Pipes		Both Liquid and Gas Pipes	
Piping Connections	Liquid	in. (mm)	φ 1/4 (φ 6.4)		φ 1/4 (φ 6.4)	
	Gas	in. (mm)	φ 3/8 (φ 9.5)		φ 3/8 (φ 9.5)	
	Drain	in. (mm)	φ 11/16 (φ 18)		φ 11/16 (φ 18)	
Drawing No.			3D105562		3D105565	

Model			CTXG12QVJUW		CTXG12QVJUS	
			Cooling	Heating	Cooling	Heating
Rated Capacity			12 kBtu/h Class		12 kBtu/h Class	
Front Panel Color			White		Silver	
Airflow Rate	H	cfm (m ³ /min)	353 (10.0)	420 (11.9)	353 (10.0)	420 (11.9)
	M		230 (6.5)	300 (8.5)	230 (6.5)	300 (8.5)
	L		162 (4.6)	219 (6.2)	162 (4.6)	219 (6.2)
	SL		134 (3.8)	124 (3.5)	134 (3.8)	124 (3.5)
Fan	Type		Cross Flow Fan		Cross Flow Fan	
	Motor Output	W	29		29	
	Speed	Steps	5 Steps, Quiet, Auto		5 Steps, Quiet, Auto	
Air Direction Control			Right, Left, Horizontal, Downward		Right, Left, Horizontal, Downward	
Air Filter			Removable, Washable, Mildew Proof		Removable, Washable, Mildew Proof	
Running Current (Rated)		A	0.13 - 0.12	0.19 - 0.17	0.13 - 0.12	0.19 - 0.17
Power Consumption (Rated)		W	26 - 26	38 - 38	26 - 26	38 - 38
Power Factor (Rated)		%	96.1 - 94.2	96.1 - 97.1	96.1 - 94.2	96.1 - 97.1
Temperature Control			Microcomputer Control		Microcomputer Control	
Dimensions (H x W x D)		in. (mm)	11-15/16 x 39-5/16 x 8-3/8 (303 x 998 x 212)		11-15/16 x 39-5/16 x 8-3/8 (303 x 998 x 212)	
Packaged Dimensions (H x W x D)		in. (mm)	12-11/16 x 43-3/8 x 15-5/16 (322 x 1,101 x 389)		12-11/16 x 43-3/8 x 15-5/16 (322 x 1,101 x 389)	
Weight (Mass)		Lbs (kg)	27 (12)		27 (12)	
Gross Weight (Gross Mass)		Lbs (kg)	36 (16)		36 (16)	
Sound Pressure Level	H / M / L / SL	dB(A)	45 / 34 / 26 / 22	45 / 37 / 29 / 22	45 / 34 / 26 / 22	45 / 37 / 29 / 22
Sound Power Level		dB	—	—	—	—
Heat Insulation			Both Liquid and Gas Pipes		Both Liquid and Gas Pipes	
Piping Connections	Liquid	in. (mm)	φ 1/4 (φ 6.4)		φ 1/4 (φ 6.4)	
	Gas	in. (mm)	φ 3/8 (φ 9.5)		φ 3/8 (φ 9.5)	
	Drain	in. (mm)	φ 11/16 (φ 18)		φ 11/16 (φ 18)	
Drawing No.			3D105563		3D105566	

Conversion Formulae
kcal/h = kW × 860
Btu/h = kW × 3412
cfm = m ³ /min × 35.3

60 Hz, 208 - 230 V

Model			CTXG18QVJUW		CTXG18QVJUS	
			Cooling	Heating	Cooling	Heating
Rated Capacity			18 kBtu/h Class		18 kBtu/h Class	
Front Panel Color			White		Silver	
Airflow Rate	H	cfm (m ³ /min)	364 (10.3)	438 (12.4)	364 (10.3)	438 (12.4)
	M		286 (8.1)	350 (9.9)	286 (8.1)	350 (9.9)
	L		233 (6.6)	265 (7.5)	233 (6.6)	265 (7.5)
	SL		219 (6.2)	212 (6)	219 (6.2)	212 (6)
Fan	Type		Cross Flow Fan		Cross Flow Fan	
	Motor Output	W	29		29	
	Speed	Steps	5 Steps, Quiet, Auto		5 Steps, Quiet, Auto	
Air Direction Control			Right, Left, Horizontal, Downward		Right, Left, Horizontal, Downward	
Air Filter			Removable, Washable, Mildew Proof		Removable, Washable, Mildew Proof	
Running Current (Rated)		A	0.14 - 0.14	0.21 - 0.21	0.14 - 0.14	0.21 - 0.21
Power Consumption (Rated)		W	28 - 28	42 - 42	28 - 28	42 - 42
Power Factor (Rated)		%	96.1 - 87.0	96.2 - 87.0	96.1 - 87.0	96.2 - 87.0
Temperature Control			Microcomputer Control		Microcomputer Control	
Dimensions (H x W x D)		in. (mm)	11-15/16 x 39-5/16 x 8-3/8 (303 x 998 x 212)		11-15/16 x 39-5/16 x 8-3/8 (303 x 998 x 212)	
Packaged Dimensions (H x W x D)		in. (mm)	12-11/16 x 43-3/8 x 15-5/16 (322 x 1,101 x 389)		12-11/16 x 43-3/8 x 15-5/16 (322 x 1,101 x 389)	
Weight (Mass)		Lbs (kg)	27 (12)		27 (12)	
Gross Weight (Gross Mass)		Lbs (kg)	36 (16)		36 (16)	
Sound Pressure Level	H / M / L / SL	dB(A)	46 / 40 / 35 / 32	47 / 41 / 35 / 32	46 / 40 / 35 / 32	47 / 41 / 35 / 32
Sound Power Level		dB	—		—	
Heat Insulation			Both Liquid and Gas Pipes		Both Liquid and Gas Pipes	
Piping Connections	Liquid	in. (mm)	φ 1/4 (φ 6.4)		φ 1/4 (φ 6.4)	
	Gas	in. (mm)	φ 1/2 (φ 12.7)		φ 1/2 (φ 12.7)	
	Drain	in. (mm)	φ 11/16 (φ 18)		φ 11/16 (φ 18)	
Drawing No.			3D105564		3D105567	

Conversion Formulae
kcal/h = kW × 860
Btu/h = kW × 3412
cfm = m ³ /min × 35.3

1.2 CTXS, FTXS Series

60 Hz, 208 - 230 V

Model			CTXS07LVJU	
			Cooling	Heating
Rated Capacity			7 kBtu/h Class	
Front Panel Color			White	
Airflow Rate	H	cfm (m³/min)	332 (9.4)	350 (9.9)
	M		261 (7.4)	290 (8.2)
	L		194 (5.5)	233 (6.6)
	SL		145 (4.1)	219 (6.2)
Fan	Type		Cross Flow Fan	
	Motor Output	W	23	
	Speed	Steps	5 Steps, Quiet, Auto	
Air Direction Control			Right, Left, Horizontal, Downward	
Air Filter			Removable, Washable, Mildew Proof	
Running Current (Rated)		A	0.09 - 0.08	0.11 - 0.10
Power Consumption (Rated)		W	18 - 18	21 - 21
Power Factor (Rated)		%	96.2 - 97.8	91.8 - 91.3
Temperature Control			Microcomputer Control	
Dimensions (H x W x D)		in. (mm)	11-5/8 x 31-1/2 x 8-7/16 (295 x 800 x 215)	
Packaged Dimensions (H x W x D)		in. (mm)	10-13/16 x 34-1/4 x 14-7/16 (274 x 870 x 366)	
Weight (Mass)		Lbs (kg)	20 (9)	
Gross Weight (Gross Mass)		Lbs (kg)	29 (13)	
Sound Pressure Level	H / M / L / SL	dB(A)	38 / 32 / 25 / 22	38 / 33 / 28 / 25
Sound Power Level		dB	54	54
Heat Insulation			Both Liquid and Gas Pipes	
Piping Connections	Liquid	in. (mm)	φ 1/4 (φ 6.4)	
	Gas	in. (mm)	φ 3/8 (φ 9.5)	
	Drain	in. (mm)	φ 5/8 (φ 16.0)	
Drawing No.			3D075490	

Model			FTXS09LVJU		FTXS12LVJU	
			Cooling	Heating	Cooling	Heating
Rated Capacity			9 kBtu/h Class		12 kBtu/h Class	
Front Panel Color			White		White	
Airflow Rate	H	cfm (m³/min)	381 (10.8)	420 (11.9)	403 (11.4)	438 (12.4)
	M		279 (7.9)	321 (9.1)	307 (8.7)	335 (9.5)
	L		194 (5.5)	233 (6.6)	205 (5.8)	240 (6.8)
	SL		145 (4.1)	219 (6.2)	155 (4.4)	212 (6.0)
Fan	Type		Cross Flow Fan		Cross Flow Fan	
	Motor Output	W	23		23	
	Speed	Steps	5 Steps, Quiet, Auto		5 Steps, Quiet, Auto	
Air Direction Control			Right, Left, Horizontal, Downward		Right, Left, Horizontal, Downward	
Air Filter			Removable, Washable, Mildew Proof		Removable, Washable, Mildew Proof	
Running Current (Rated)		A	0.09 - 0.08	0.11 - 0.10	0.13 - 0.12	0.14 - 0.13
Power Consumption (Rated)		W	18 - 18	21 - 21	26 - 26	28 - 28
Power Factor (Rated)		%	96.2 - 97.8	91.8 - 91.3	96.2 - 94.2	96.2 - 93.6
Temperature Control			Microcomputer Control		Microcomputer Control	
Dimensions (H x W x D)		in. (mm)	11-5/8 x 31-1/2 x 8-7/16 (295 x 800 x 215)		11-5/8 x 31-1/2 x 8-7/16 (295 x 800 x 215)	
Packaged Dimensions (H x W x D)		in. (mm)	10-13/16 x 34-1/4 x 14-7/16 (274 x 870 x 366)		10-13/16 x 34-1/4 x 14-7/16 (274 x 870 x 366)	
Weight (Mass)		Lbs (kg)	20 (9)		22 (10)	
Gross Weight (Gross Mass)		Lbs (kg)	29 (13)		31 (14)	
Sound Pressure Level	H / M / L / SL	dB(A)	41 / 33 / 25 / 22	42 / 35 / 28 / 25	45 / 37 / 29 / 23	45 / 39 / 29 / 26
Sound Power Level		dB	57	58	61	61
Heat Insulation			Both Liquid and Gas Pipes		Both Liquid and Gas Pipes	
Piping Connections	Liquid	in. (mm)	φ 1/4 (φ 6.4)		φ 1/4 (φ 6.4)	
	Gas	in. (mm)	φ 3/8 (φ 9.5)		φ 3/8 (φ 9.5)	
	Drain	in. (mm)	φ 5/8 (φ 16)		φ 5/8 (φ 16)	
Drawing No.			3D075491A		3D075492A	

<p>Conversion Formulae</p> <p>kcal/h = kW x 860</p> <p>Btu/h = kW x 3412</p> <p>cfm = m³/min x 35.3</p>

60 Hz, 208 - 230 V

Model			FTXS15LVJU		FTXS18LVJU	
			Cooling	Heating	Cooling	Heating
Rated Capacity			15 kBtu/h Class		18 kBtu/h Class	
Front Panel Color			White		White	
Airflow Rate	H	cfm (m ³ /min)	568 (16.1)	593 (16.8)	583 (16.5)	625 (17.7)
	M		477 (13.5)	505 (14.3)	484 (13.7)	526 (14.9)
	L		385 (10.9)	417 (11.8)	385 (10.9)	431 (12.2)
	SL		360 (10.2)	371 (10.5)	360 (10.2)	399 (11.3)
Fan	Type		Cross Flow Fan		Cross Flow Fan	
	Motor Output	W	48		48	
	Speed	Steps	5 Steps, Quiet, Auto		5 Steps, Quiet, Auto	
Air Direction Control			Right, Left, Horizontal, Downward		Right, Left, Horizontal, Downward	
Air Filter			Removable, Washable, Mildew Proof		Removable, Washable, Mildew Proof	
Running Current (Rated)		A	0.31 - 0.29	0.31 - 0.29	0.32 - 0.30	0.32 - 0.30
Power Consumption (Rated)		W	38 - 38	38 - 38	38 - 38	38 - 38
Power Factor (Rated)		%	58.9 - 57.0	58.9 - 57.0	57.1 - 55.1	57.1 - 55.1
Temperature Control			Microcomputer Control		Microcomputer Control	
Dimensions (H x W x D)		in. (mm)	13-3/8 x 41-5/16 x 9-3/4 (340 x 1,050 x 248)		13-3/8 x 41-5/16 x 9-3/4 (340 x 1,050 x 248)	
Packaged Dimensions (H x W x D)		in. (mm)	13 x 45-11/16 x 16-7/8 (331 x 1,160 x 429)		13 x 45-11/16 x 16-7/8 (331 x 1,160 x 429)	
Weight (Mass)		Lbs (kg)	31 (14)		31 (14)	
Gross Weight (Gross Mass)		Lbs (kg)	44 (20)		44 (20)	
Sound Pressure Level	H / M / L / SL	dB(A)	45 / 40 / 35 / 32	43 / 38 / 33 / 30	46 / 41 / 36 / 33	45 / 40 / 35 / 32
Sound Power Level		dB	61	59	62	61
Heat Insulation			Both Liquid and Gas Pipes		Both Liquid and Gas Pipes	
Piping Connections	Liquid	in. (mm)	φ 1/4 (φ 6.4)		φ 1/4 (φ 6.4)	
	Gas	in. (mm)	φ 1/2 (φ 12.7)		φ 1/2 (φ 12.7)	
	Drain	in. (mm)	φ 5/8 (φ 16)		φ 5/8 (φ 16)	
Drawing No.			3D075043A		3D075044A	

Model			FTXS24LVJU	
			Cooling	Heating
Rated Capacity			24 kBtu/h Class	
Front Panel Color			White	
Airflow Rate	H	cfm (m ³ /min)	643 (18.2)	699 (19.8)
	M		494 (14.0)	572 (16.2)
	L		350 (9.9)	445 (12.6)
	SL		328 (9.3)	403 (11.4)
Fan	Type		Cross Flow Fan	
	Motor Output	W	48	
	Speed	Steps	5 Steps, Quiet, Auto	
Air Direction Control			Right, Left, Horizontal, Downward	
Air Filter			Removable, Washable, Mildew Proof	
Running Current (Rated)		A	0.57 - 0.51	0.57 - 0.51
Power Consumption (Rated)		W	69 - 68	69 - 68
Power Factor (Rated)		%	58.2 - 58.0	58.2 - 58.0
Temperature Control			Microcomputer Control	
Dimensions (H x W x D)		in. (mm)	13-3/8 x 41-5/16 x 9-3/4 (340 x 1,050 x 248)	
Packaged Dimensions (H x W x D)		in. (mm)	13 x 45-11/16 x 16-7/8 (331 x 1,160 x 429)	
Weight (Mass)		Lbs (kg)	31 (14)	
Gross Weight (Gross Mass)		Lbs (kg)	46 (21)	
Sound Pressure Level	H / M / L / SL	dB(A)	51 / 44 / 37 / 34	48 / 42 / 37 / 34
Sound Power Level		dB	67	64
Heat Insulation			Both Liquid and Gas Pipes	
Piping Connections	Liquid	in. (mm)	φ 1/4 (φ 6.4)	
	Gas	in. (mm)	φ 5/8 (φ 15.9)	
	Drain	in. (mm)	φ 5/8 (φ 16)	
Drawing No.			3D075045A	

Conversion Formulae
kcal/h = kW × 860
Btu/h = kW × 3412
cfm = m ³ /min × 35.3

1.3 FDXS, CDXS Series

60 Hz, 208 - 230 V

Model			FDXS09LVJU		FDXS12LVJU	
			Cooling	Heating	Cooling	Heating
Rated Capacity			9 kBtu/h Class		12 kBtu/h Class	
External Static Pressure		inAq (Pa)	0.12 (30)		0.12 (30)	
Airflow Rate	H	cfm (m ³ /min)	305 (8.6)	305 (8.6)	305 (8.6)	305 (8.6)
	M		280 (7.9)	280 (7.9)	280 (7.9)	280 (7.9)
	L		260 (7.4)	260 (7.4)	260 (7.4)	260 (7.4)
	SL		235 (6.7)	235 (6.7)	235 (6.7)	235 (6.7)
Fan	Type		Sirocco Fan		Sirocco Fan	
	Motor Output	W	62		62	
	Speed	Steps	5 Steps, Quiet, Auto		5 Steps, Quiet, Auto	
Air Filter			Removable, Washable, Mildew Proof		Removable, Washable, Mildew Proof	
Running Current (Rated)		A	0.58 - 0.52	0.58 - 0.52	0.58 - 0.52	0.58 - 0.52
Power Consumption (Rated)		W	72 - 72	72 - 72	72 - 72	72 - 72
Power Factor (Rated)		%	59.7 - 60.2	59.7 - 60.2	59.7 - 60.2	59.7 - 60.2
Temperature Control			Microcomputer Control		Microcomputer Control	
Dimensions (H x W x D)		in. (mm)	7-7/8 x 27-9/16 x 24-7/16 (200 x 700 x 620)		7-7/8 x 27-9/16 x 24-7/16 (200 x 700 x 620)	
Packaged Dimensions (H x W x D)		in. (mm)	10-13/16 x 36-5/16 x 30-1/4 (274 x 923 x 768)		10-13/16 x 36-5/16 x 30-1/4 (274 x 923 x 768)	
Weight (Mass)		Lbs (kg)	47 (21)		47 (21)	
Gross Weight (Gross Mass)		Lbs (kg)	64 (29)		64 (29)	
Sound Pressure Level	H / M / L	dB(A)	35 / 33 / 31	35 / 33 / 31	35 / 33 / 31	35 / 33 / 31
Sound Power Level		dB	51	51	51	51
Heat Insulation			Both Liquid and Gas Pipes		Both Liquid and Gas Pipes	
Piping Connections	Liquid	in. (mm)	φ 1/4 (φ 6.4)		φ 1/4 (φ 6.4)	
	Gas	in. (mm)	φ 3/8 (φ 9.5)		φ 3/8 (φ 9.5)	
	Drain	in. (mm)	φ 25/32 (φ 20)		φ 25/32 (φ 20)	
Drawing No.			3D075493		3D075494	

Model			CDXS15LVJU		CDXS18LVJU	
			Cooling	Heating	Cooling	Heating
Rated Capacity			15 kBtu/h Class		18 kBtu/h Class	
External Static Pressure		inAq (Pa)	0.16 (40)		0.16 (40)	
Airflow Rate	H	cfm (m ³ /min)	424 (12.0)	424 (12.0)	424 (12.0)	424 (12.0)
	M		388 (11.0)	388 (11.0)	388 (11.0)	388 (11.0)
	L		353 (10.0)	353 (10.0)	353 (10.0)	353 (10.0)
	SL		297 (8.4)	297 (8.4)	297 (8.4)	297 (8.4)
Fan	Type		Sirocco Fan		Sirocco Fan	
	Motor Output	W	130		130	
	Speed	Steps	5 Steps, Quiet, Auto		5 Steps, Quiet, Auto	
Air Filter			Removable, Washable, Mildew Proof		Removable, Washable, Mildew Proof	
Running Current (Rated)		A	0.79	0.79	0.79	0.79
Power Consumption (Rated)		W	172	172	172	172
Power Factor (Rated)		%	94.4	94.4	94.4	94.4
Temperature Control			Microcomputer Control		Microcomputer Control	
Dimensions (H x W x D)		in. (mm)	7-7/8 x 35-7/16 x 24-7/16 (200 x 900 x 620)		7-7/8 x 35-7/16 x 24-7/16 (200 x 900 x 620)	
Packaged Dimensions (H x W x D)		in. (mm)	10-1/2 x 43-9/16 x 29-9/16 (266 x 1,106 x 751)		10-1/2 x 43-9/16 x 29-9/16 (266 x 1,106 x 751)	
Weight (Mass)		Lbs (kg)	60 (27)		60 (27)	
Gross Weight (Gross Mass)		Lbs (kg)	75 (34)		75 (34)	
Sound Pressure Level	H / M / L / SL	dB(A)	37 / 35 / 33 / 31	37 / 35 / 33 / 31	37 / 35 / 33 / 31	37 / 35 / 33 / 31
Heat Insulation			Both Liquid and Gas Pipes		Both Liquid and Gas Pipes	
Piping Connections	Liquid	in. (mm)	φ 1/4 (φ 6.4)		φ 1/4 (φ 6.4)	
	Gas	in. (mm)	φ 1/2 (φ 12.7)		φ 1/2 (φ 12.7)	
	Drain	in. (mm)	VP20 (O.D. φ 1-1/32 (φ 26), I.D. φ 25/32 (φ 20))		VP20 (O.D. φ 1-1/32 (φ 26), I.D. φ 25/32 (φ 20))	
Drawing No.			C: 3D075721		C: 3D075722	

Conversion Formulae
kcal/h = kW × 860
Btu/h = kW × 3412
cfm = m ³ /min × 35.3

60 Hz, 208 - 230 V

Model			CDXS24LVJU	
			Cooling	Heating
Rated Capacity			24 kBtu/h Class	
External Static Pressure		inAq (Pa)	0.16 (40)	
Airflow Rate	H	cfm (m ³ /min)	565 (16.0)	565 (16.0)
	M		523 (14.8)	523 (14.8)
	L		477 (13.5)	477 (13.5)
	SL		395 (11.2)	395 (11.2)
Fan	Type	Sirocco Fan		
	Motor Output	W	130	
	Speed	Steps	5 Steps, Quiet, Auto	
Air Filter			Removable, Washable, Mildew Proof	
Running Current (Rated)		A	0.79	0.79
Power Consumption (Rated)		W	160	160
Power Factor (Rated)		%	90.3	92.8
Temperature Control			Microcomputer Control	
Dimensions (H x W x D)		in. (mm)	7-7/8 x 43-5/16 x 24-7/16 (200 x 1,100 x 620)	
Packaged Dimensions (H x W x D)		in. (mm)	10-1/2 x 52-1/16 x 30-1/4 (266 x 1,323 x 768)	
Weight (Mass)		Lbs (kg)	66 (30)	
Gross Weight (Gross Mass)		Lbs (kg)	84 (38)	
Sound Pressure Level	H / M / L / SL	dB(A)	38 / 36 / 34 / 32	38 / 36 / 34 / 32
Heat Insulation			Both Liquid and Gas Pipes	
Piping Connections	Liquid	in. (mm)	φ 1/4 (φ 6.4)	
	Gas	in. (mm)	φ 5/8 (φ 15.9)	
	Drain	in. (mm)	VP20 (O.D. φ 1-1/32 (φ 26), I.D. φ 25/32 (φ 20))	
Drawing No.			3D080590	

Conversion Formulae
kcal/h = kW × 860
Btu/h = kW × 3412
cfm = m ³ /min × 35.3

1.4 FVXS Series

60 Hz, 208 - 230 V

Model			FVXS09NVJU		FVXS12NVJU	
			Cooling	Heating	Cooling	Heating
Rated Capacity			9 kBtu/h Class		12 kBtu/h Class	
Front Panel Color			White		White	
Airflow Rate	H	cfm (m ³ /min)	290 (8.2)	311 (8.8)	300 (8.5)	332 (9.4)
	M		230 (6.5)	244 (6.9)	237 (6.7)	258 (7.3)
	L		169 (4.8)	177 (5.0)	173 (4.9)	184 (5.2)
	SL		145 (4.1)	155 (4.4)	159 (4.5)	166 (4.7)
Fan	Type		Turbo Fan		Turbo Fan	
	Motor Output	W	12.3		13.4	
	Speed	Steps	5 Steps, Quiet, Auto		5 Steps, Quiet, Auto	
Air Direction Control			Right, Left, Horizontal, Downward		Right, Left, Horizontal, Downward	
Air Filter			Removable, Washable, Mildew Proof		Removable, Washable, Mildew Proof	
Running Current (Rated)		A	0.14 - 0.13	0.15 - 0.14	0.14 - 0.13	0.15 - 0.14
Power Consumption (Rated)		W	15 - 15	17 - 17	15 - 15	17 - 17
Power Factor (Rated)		%	51.5 - 50.2	54.5 - 52.8	51.5 - 50.2	54.5 - 52.8
Temperature Control			Microcomputer Control		Microcomputer Control	
Dimensions (H x W x D)		in. (mm)	23-5/8 x 27-9/16 x 8-1/4 (600 x 700 x 210)		23-5/8 x 27-9/16 x 8-1/4 (600 x 700 x 210)	
Packaged Dimensions (H x W x D)		in. (mm)	27-3/8 x 30-15/16 x 11 (695 x 786 x 279)		27-3/8 x 30-15/16 x 11 (695 x 786 x 279)	
Weight (Mass)		Lbs (kg)	31 (14)		31 (14)	
Gross Weight (Gross Mass)		Lbs (kg)	40 (18)		40 (18)	
Sound Pressure Level	H / M / L / SL	dB(A)	38 / 32 / 26 / 23	38 / 32 / 26 / 23	39 / 33 / 27 / 24	39 / 33 / 27 / 24
Sound Power Level		dB	—	—	—	—
Heat Insulation			Both Liquid and Gas Pipes		Both Liquid and Gas Pipes	
Piping Connections	Liquid	in. (mm)	ϕ 1/4 (ϕ 6.4)		ϕ 1/4 (ϕ 6.4)	
	Gas	in. (mm)	ϕ 3/8 (ϕ 9.5)		ϕ 3/8 (ϕ 9.5)	
	Drain	in. (mm)	ϕ 13/16 (ϕ 20)		ϕ 13/16 (ϕ 20)	
Drawing No.			3D101722		3D101724	

Model			FVXS15NVJU		FVXS18NVJU	
			Cooling	Heating	Cooling	Heating
Rated Capacity			15 kBtu/h Class		18 kBtu/h Class	
Front Panel Color			White		White	
Airflow Rate	H	cfm (m ³ /min)	378 (10.7)	417 (11.8)	378 (10.7)	417 (11.8)
	M		325 (9.2)	357 (10.1)	325 (9.2)	357 (10.1)
	L		275 (7.8)	300 (8.5)	275 (7.8)	300 (8.5)
	SL		233 (6.6)	251 (7.1)	233 (6.6)	251 (7.1)
Fan	Type		Turbo Fan		Turbo Fan	
	Motor Output	W	23.3		23.3	
	Speed	Steps	5 Steps, Quiet, Auto		5 Steps, Quiet, Auto	
Air Direction Control			Right, Left, Horizontal, Downward		Right, Left, Horizontal, Downward	
Air Filter			Removable, Washable, Mildew Proof		Removable, Washable, Mildew Proof	
Running Current (Rated)		A	0.19 - 0.17	0.21 - 0.19	—	—
Power Consumption (Rated)		W	27 - 27	34 - 34	—	—
Power Factor (Rated)		%	68.3 - 69.1	77.8 - 77.8	—	—
Temperature Control			Microcomputer Control		Microcomputer Control	
Dimensions (H x W x D)		in. (mm)	23-5/8 x 27-9/16 x 8-1/4 (600 x 700 x 210)		23-5/8 x 27-9/16 x 8-1/4 (600 x 700 x 210)	
Packaged Dimensions (H x W x D)		in. (mm)	27-3/8 x 30-15/16 x 11 (696 x 786 x 280)		27-3/8 x 30-15/16 x 11 (695 x 786 x 279)	
Weight (Mass)		Lbs (kg)	31 (14)		31 (14)	
Gross Weight (Gross Mass)		Lbs (kg)	40 (18)		40 (18)	
Sound Pressure Level	H / M / L / SL	dB(A)	44 / 40 / 36 / 32	45 / 40 / 36 / 32	44 / 40 / 36 / 32	45 / 40 / 36 / 32
Sound Power Level		dB	—	—	—	—
Heat Insulation			Both Liquid and Gas Pipes		Both Liquid and Gas Pipes	
Piping Connections	Liquid	in. (mm)	ϕ 1/4 (ϕ 6.4)		ϕ 1/4 (ϕ 6.4)	
	Gas	in. (mm)	ϕ 1/2 (ϕ 12.7)		ϕ 1/2 (ϕ 12.7)	
	Drain	in. (mm)	ϕ 13/16 (ϕ 20.0)		ϕ 13/16 (ϕ 20)	
Drawing No.			3D101718		3D094866	

Conversion Formulae

kcal/h = kW × 860
 Btu/h = kW × 3412
 cfm = m³/min × 35.3

1.5 FFQ Series

60 Hz, 208 - 230 V

Model			FFQ09Q2VJU		FFQ12Q2VJU	
			Cooling	Heating	Cooling	Heating
Rated Capacity ★			9 kBtu/h Class		12 kBtu/h Class	
Decoration Panel (1)	Model		BYFQ60B3W1		BYFQ60B3W1	
	Color		White		White	
	Dimensions (H × W × D)	in. (mm)	2-3/16 × 27-9/16 × 27-9/16 (55 × 700 × 700)		2-3/16 × 27-9/16 × 27-9/16 (55 × 700 × 700)	
	Weight (Mass)	Lbs (kg)	6 (2.7)		6 (2.7)	
Decoration Panel (2)	Model		BYFQ60C2W1W / BYFQ60C2W1S		BYFQ60C2W1W / BYFQ60C2W1S	
	Color		White / Silver		White / Silver	
	Dimensions (H × W × D)	in. (mm)	1-13/16 × 24-7/16 × 24-7/16 (46 × 620 × 620)		1-13/16 × 24-7/16 × 24-7/16 (46 × 620 × 620)	
	Weight (Mass)	Lbs (kg)	6.2 (2.8)		6.2 (2.8)	
Airflow Rate	H	cfm (m³/min)	378 (10.7)	399 (11.3)	406 (11.5)	427 (12.1)
	M		339 (9.6)	357 (10.1)	353 (10.0)	371 (10.5)
	L		268 (7.6)	282 (8.0)	268 (7.6)	282 (8.0)
Fan	Type		Turbo Fan		Turbo Fan	
	Motor Output	W	—		—	
	Speed	Steps	3 Steps		3 Steps	
Air Direction Control			—		—	
Running Current (Rated)	A	0.23 - 0.21	0.23 - 0.21	0.27 - 0.24	0.27 - 0.24	
Power Consumption (Rated)	W	23	23	27	27	
Power Factor (Rated)	%	48.1 - 47.6	48.1 - 47.6	48.1 - 48.9	48.1 - 48.9	
Temperature Control			Microcomputer Control		Microcomputer Control	
Dimensions (H × W × D)	in. (mm)	10-1/4 × 22-5/8 × 22-5/8 (260 × 575 × 575)		10-1/4 × 22-5/8 × 22-5/8 (260 × 575 × 575)		
Packaged Dimensions (H × W × D)	in. (mm)	11 × 27 × 23-1/2 (280 × 686 × 597)		11 × 27 × 23-1/2 (280 × 686 × 597)		
Weight (Mass)	Lbs (kg)	36 (16)		36 (16)		
Gross Weight (Gross Mass)	Lbs (kg)	40 (18)		40 (18)		
Sound Pressure Level	H / M / L	dB(A)	38 / 35 / 29	38 / 35 / 29	39 / 36 / 30	
Heat Insulation			Both Liquid and Gas Pipes		Both Liquid and Gas Pipes	
Piping Connections	Liquid	in. (mm)	φ 1/4 (φ 6.4)		φ 1/4 (φ 6.4)	
	Gas	in. (mm)	φ 3/8 (φ 9.5)		φ 3/8 (φ 9.5)	
	Drain	in. (mm)	VP20 (O.D. φ 1-1/32 (φ 26))		VP20 (O.D. φ 1-1/32 (φ 26))	
Drawing No.			3D106061A		3D106062	

Model			FFQ15Q2VJU		FFQ18Q2VJU	
			Cooling	Heating	Cooling	Heating
Rated Capacity ★			15 kBtu/h Class		18 kBtu/h Class	
Decoration Panel (1)	Model		BYFQ60B3W1		BYFQ60B3W1	
	Color		White		White	
	Dimensions (H × W × D)	in. (mm)	2-3/16 × 27-9/16 × 27-9/16 (55 × 700 × 700)		2-3/16 × 27-9/16 × 27-9/16 (55 × 700 × 700)	
	Weight (Mass)	Lbs (kg)	6 (2.7)		6 (2.7)	
Decoration Panel (2)	Model		BYFQ60C2W1W / BYFQ60C2W1S		BYFQ60C2W1W / BYFQ60C2W1S	
	Color		White / Silver		White / Silver	
	Dimensions (H × W × D)	in. (mm)	1-13/16 × 24-7/16 × 24-7/16 (46 × 620 × 620)		1-13/16 × 24-7/16 × 24-7/16 (46 × 620 × 620)	
	Weight (Mass)	Lbs (kg)	6.2 (2.8)		6.2 (2.8)	
Airflow Rate	H	cfm (m³/min)	420 (11.9)	441 (12.5)	448 (12.7)	498 (14.1)
	M		367 (10.4)	385 (10.9)	378 (10.7)	420 (11.9)
	L		293 (8.3)	307 (8.7)	275 (7.8)	307 (8.7)
Fan	Type		Turbo Fan		Turbo Fan	
	Motor Output	W	—		—	
	Speed	Steps	3 Steps		3 Steps	
Air Direction Control			—		—	
Running Current (Rated)	A	0.29 - 0.26	0.29 - 0.26	0.52 - 0.47	0.52 - 0.47	
Power Consumption (Rated)	W	28	28	51 - 51	51 - 51	
Power Factor (Rated)	%	46.4 - 46.8	46.4 - 46.8	47.2 - 47.2	47.2 - 47.2	
Temperature Control			Microcomputer Control		Microcomputer Control	
Dimensions (H × W × D)	in. (mm)	10-1/4 × 22-5/8 × 22-5/8 (260 × 575 × 575)		10-1/4 × 22-5/8 × 22-5/8 (260 × 575 × 575)		
Packaged Dimensions (H × W × D)	in. (mm)	11 × 27 × 23-1/2 (280 × 686 × 597)		11 × 27 × 23-1/2 (280 × 686 × 597)		
Weight (Mass)	Lbs (kg)	36 (16)		39.0 (17.5)		
Gross Weight (Gross Mass)	Lbs (kg)	40 (18)		42.0 (19.0)		
Sound Pressure Level	H / M / L	dB(A)	40 / 37 / 31	40 / 37 / 31	44 / 40 / 32	
Heat Insulation			Both Liquid and Gas Pipes		Both Liquid and Gas Pipes	
Piping Connections	Liquid	in. (mm)	φ 1/4 (φ 6.4)		φ 1/4 (φ 6.4)	
	Gas	in. (mm)	φ 1/2 (φ 12.7)		φ 1/2 (φ 12.7)	
	Drain	in. (mm)	VP20 (O.D. φ 1-1/32 (φ 26))		VP20 (O.D. φ 1-1/32 (φ 26))	
Drawing No.			3D106063A		3D106064	

Conversion Formulae
kcal/h = kW × 860
Btu/h = kW × 3412
cfm = m³/min × 35.3

2. Outdoor Unit

60 Hz, 208 - 230 V

Model		2MXS18NMVJU	
		Cooling	Heating
COP ★	W/W	—	4.1
EER ★	Btu/W·h	9.5 ~ 12.5	—
SEER / HSPF		14.0 ~ 18.9	8.2 ~ 10.7
Casing Color		Ivory White	
Compressor	Type	Hermetically Sealed Swing Type	
	Model	2YC36PXD	
	Motor Output	W 1,100	
Refrigerant Oil	Model	FVC50K	
	Charge	oz (L) 21.5 (0.61)	
Refrigerant	Type	R-410A	
	Charge	Lbs (kg) 3.86 (1.75)	
Airflow Rate	H	2,150	2,179
	M	2,150	2,179
	L	1,953	1,119
	H	60.9	61.7
	M	60.9	61.7
	L	55.3	31.7
Fan	Type	Propeller	
	Motor Output	W 56	
	Running Current	A H: 0.29 / M: 0.29 / L: 0.25 H: 0.29 / M: 0.29 / L: 0.05	
	Power Consumption	W H: 65 / M: 65 / L: 58 H: 66 / M: 66 / L: 12	
Starting Current	A	14.0	
Dimension (H × W × D)	in. (mm)	28-15/16 × 34-1/4 × 12-5/8 (735 × 870 × 320)	
Packaged Dimension (H × W × D)	in. (mm)	31-7/8 × 41-9/16 × 17-1/2 (810 × 1,056 × 444)	
Weight (Mass)	Lbs (kg)	123 (56)	
Gross Weight (Gross Mass)	Lbs (kg)	141 (64)	
Sound Pressure Level	dB(A)	50	51
Piping Connections	Liquid	in. (mm) φ 1/4 × 2 (φ 6.4 × 2)	
	Gas	in. (mm) φ 3/8 × 1, φ 1/2 × 1 (φ 9.5 × 2, φ 12.7 × 1)	
	Drain	in. (mm) φ 11/16 (φ 18.0)	
Heat Insulation		Both Liquid and Gas Pipes	
No. of Wiring Connections		3 for Power Supply, 4 for Interunit Wiring	
Max. Interunit Piping Length	ft (m)	164 (50) (for Total of Each Room)	
		82 (25) (for One Room)	
Amount of Additional Charge of Refrigerant	oz/ft (g/m)	0.21 (20) (98-3/8 ft (30 m) or more)	
Max. Installation Height Difference	ft (m)	49-1/4 (15) (between Indoor Unit and Outdoor Unit)	
		24-5/8 (7.5) (between Indoor Units)	
Drawing No.		3D093257	

- Notes:**
- ★ Max.: for the combination of CTXS, FTXS series indoor units
Min.: for the combination of CDXS, FDXS series indoor units
 - The data are based on the conditions shown in the table below.

Cooling	Indoor ; 80°FDB (26.7°CDB) / 67°FWB (19.4°CWB) Outdoor ; 95°FDB (35°CDB) / 75°FWB (24°CWB)
Heating	Indoor ; 70°FDB (21°CDB) / 60°FWB (15.6°CWB) Outdoor ; 47°FDB (8.3°CDB) / 43°FWB (6°CWB)
Piping Length	25 ft (7.5 m)

Conversion Formulae
kcal/h = kW × 860
Btu/h = kW × 3412
cfm = m³/min × 35.3

60 Hz, 208 - 230 V

Model		3MXS24NMVJU	
		Cooling	Heating
COP ★	W/W	—	3.2 ~ 4.6
EER ★	Btu/W·h	9.7 ~ 12.7	—
SEER / HSPF		14.0 ~ 17.9	8.2 ~ 12.5
Casing Color		Ivory White	
Compressor	Type	Hermetically Sealed Swing Type	
	Model	2YC63AAXD	
	Motor Output	W	1,920
Refrigerant Oil	Model	FVC50K	
	Charge	oz (L)	29.8 (0.85)
Refrigerant	Type	R-410A	
	Charge	Lbs (kg)	6.17 (2.8)
Airflow Rate	H	cfm	2,094
	M		1,981
	L		1,119
	H	m³/min	59.3
	M		56.1
	L		31.7
Fan	Type	Propeller	
	Motor Output	W	51
	Running Current	A	H: 0.28 / M: 0.28 / L: 0.26
	Power Consumption	W	H: 63 / M: 63 / L: 59
Starting Current	A	15.5	
Dimension (H × W × D)	in. (mm)	28-15/16 × 34-1/4 × 12-5/8 (735 × 870 × 320)	
Packaged Dimension (H × W × D)	in. (mm)	31-7/8 × 41-9/16 × 17-1/2 (810 × 1,056 × 444)	
Weight (Mass)	Lbs (kg)	137 (62)	
Gross Weight (Gross Mass)	Lbs (kg)	154 (70)	
Sound Pressure Level	dB(A)	52	54
Piping Connections	Liquid	in. (mm)	φ 1/4 × 3 (φ 6.4 × 3)
	Gas	in. (mm)	φ 3/8 × 1, φ 1/2 × 2 (φ 9.5 × 1, φ 12.7 × 2)
	Drain	in. (mm)	φ 11/16 (φ 17.5)
Heat Insulation		Both Liquid and Gas Pipes	
No. of Wiring Connections		3 for Power Supply, 4 for Interunit Wiring	
Max. Interunit Piping Length	ft (m)	230 (70) (for Total of Each Room)	
		82 (25) (for One Room)	
Amount of Additional Charge of Refrigerant	oz/ft (g/m)	0.21 (20) (131-5/8 ft (40 m) or more)	
Max. Installation Height Difference	ft (m)	49-1/4 (15) (between Indoor Unit and Outdoor Unit)	
		24-5/8 (7.5) (between Indoor Units)	
Drawing No.		3D093259	

- Notes:**
- ★ Max.: for the combination of CTXS, FTXS series indoor units
Min.: for the combination of CDXS, FDXS series indoor units
 - The data are based on the conditions shown in the table below.

Cooling	Indoor ; 80°FDB (26.7°CDB) / 67°FWB (19.4°CWB) Outdoor ; 95°FDB (35°CDB) / 75°FWB (24°CWB)
Heating	Indoor ; 70°FDB (21°CDB) / 60°FWB (15.6°CWB) Outdoor ; 47°FDB (8.3°CDB) / 43°FWB (6°CWB)
Piping Length	25 ft (7.5 m)

Conversion Formulae
kcal/h = kW × 860
Btu/h = kW × 3412
cfm = m³/min × 35.3

60 Hz, 208 - 230 V

Model		4MXS36NMVJU		
		Cooling	Heating	
COP ★	W/W	—	3.5 ~ 4.5	
EER ★	Btu/W·h	7.9 ~ 9.2	—	
SEER / HSPF		14.0 ~ 17.7	8.2 ~ 12.2	
Casing Color		Ivory White		
Compressor	Type	Hermetically Sealed Swing Type		
	Model	2YC63AAXD		
	Motor Output	W		
		1,920		
Refrigerant Oil	Model	FVC50K		
	Charge	oz (L)		
		29.8 (0.85)		
Refrigerant	Type	R-410A		
	Charge	Lbs (kg)		
		6.17 (2.8)		
Airflow Rate	H	cfm	2,613	2,351
	M		2,440	2,210
	L		1,727	1,119
	H	m³/min	74.0	66.6
	M		69.1	62.6
	L		59.3	31.7
Fan	Type	Propeller		
	Motor Output	W		
		75		
	Running Current	A		H: 0.52 / M: 0.40 / L: 0.27
			H: 0.38 / M: 0.32 / L: 0.06	
	Power Consumption	W		H: 116 / M: 90 / L: 61
				H: 85 / M: 72 / L: 14
Starting Current	A	17.5		
Dimension (H × W × D)	in. (mm)	28-15/16 × 34-1/4 × 12-5/8 (735 × 870 × 320)		
Packaged Dimension (H × W × D)	in. (mm)	31-7/8 × 41-9/16 × 17-1/2 (810 × 1,056 × 444)		
Weight (Mass)	Lbs (kg)	139 (63)		
Gross Weight (Gross Mass)	Lbs (kg)	157 (71)		
Sound Pressure Level	dB(A)	54		56
Piping Connections	Liquid	in. (mm)	φ 1/4 × 4 (φ 6.4 × 4)	
	Gas	in. (mm)	φ 3/8 × 1, φ 1/2 × 2, φ 5/8 × 1 (φ 9.5 × 1, φ 12.7 × 2, φ 15.9 × 1)	
	Drain	in. (mm)	φ 11/16 (φ 17.5)	
Heat Insulation		Both Liquid and Gas Pipes		
No. of Wiring Connections		3 for Power Supply, 4 for Interunit Wiring		
Max. Interunit Piping Length	ft (m)	230 (70) (for Total of Each Room)		
		82 (25) (for One Room)		
Amount of Additional Charge of Refrigerant	oz/ft (g/m)	0.21 (20) (131-5/8 ft (40 m) or more)		
Max. Installation Height Difference	ft (m)	49-1/4 (15) (between Indoor Unit and Outdoor Unit)		
		24-5/8 (7.5) (between Indoor Units)		
Drawing No.		3D093260		

Notes:

- ★ Max.: for the combination of CTXS, FTXS series indoor units
Min.: for the combination of CDXS, FDXS series indoor units
- The data are based on the conditions shown in the table below.

Cooling	Indoor ; 80°FDB (26.7°CDB) / 67°FWB (19.4°CWB) Outdoor ; 95°FDB (35°CDB) / 75°FWB (24°CWB)
Heating	Indoor ; 70°FDB (21°CDB) / 60°FWB (15.6°CWB) Outdoor ; 47°FDB (8.3°CDB) / 43°FWB (6°CWB)
Piping Length	25 ft (7.5 m)

Conversion Formulae

kcal/h = kW × 860
Btu/h = kW × 3412
cfm = m³/min × 35.3

Part 3

Printed Circuit Board Connector Wiring Diagram

1. Indoor Unit.....	21
1.1 CTXG09/12/18QVJUW(S).....	21
1.2 CTXS07LVJU, FTXS09/12LVJU	23
1.3 FTXS15/18/24LVJU	25
1.4 FDXS09/12LVJU, CDXS15/18/24LVJU	27
1.5 FVXS09/12/15/18NVJU.....	29
1.6 FFQ09/12/15/18Q2VJU.....	31
2. Wired Remote Controller.....	32
2.1 BRC1E73	32
3. Wireless Remote Controller Kit	33
3.1 BRC082A41W, BRC082A42W(S).....	33
4. Outdoor Unit.....	34

1. Indoor Unit

1.1 CTXG09/12/18QVJUW(S)

Control PCB (A1P)

- | | |
|---------------|--|
| 1) S21 | Connector for centralized control (HA) |
| 2) S25 | Connector for INTELLIGENT EYE sensor PCB (A3P) |
| 3) S32 | Indoor heat exchanger thermistor |
| 4) S41 | Connector for swing motors |
| 5) S42 | Connector for reduction motor (front panel mechanism) and limit switch |
| 6) S46 | Connector for display/signal receiver PCB (A2P) |
| 7) S200 | Connector for DC fan motor |
| 8) H1, H2, H3 | Connector for terminal strip (indoor - outdoor transmission) |
| 9) FG | Connector for terminal strip (frame ground) |
| 10) JB | Fan speed setting when compressor stops for thermostat OFF |
| | * Refer to page 218 for details. |
| 11) JC | Power failure recovery function (auto-restart) |
| | * Refer to page 218 for details. |
| 12) LED A | LED for service monitor (green) |
| 13) F1U, F2U | Fuse (3.15 A, 250 V) |
| 14) V1 | Varistor |

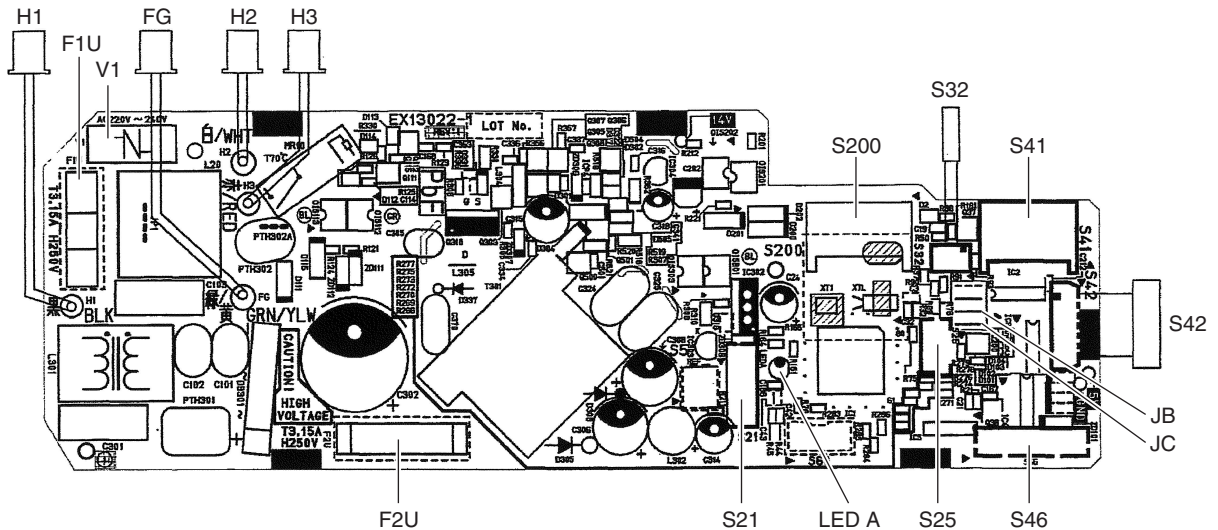

2P357399-6



Caution Replace the PCB if you accidentally cut a wrong jumper.

Jumpers are necessary for electronic circuit. Improper operation may occur if you cut any of them.

Display/Signal Receiver PCB (A2P)

- 1) S51 Connector for control PCB (A1P)
 - 2) S52 Connector for room temperature thermistor
 - 3) S1W Indoor unit **ON/OFF** button
 - 4) H1P LED for operation (multi-color)
 - 5) H2P LED for INTELLIGENT EYE (green)
 - 6) JA Address setting jumper
- * Refer to page 216 for details.

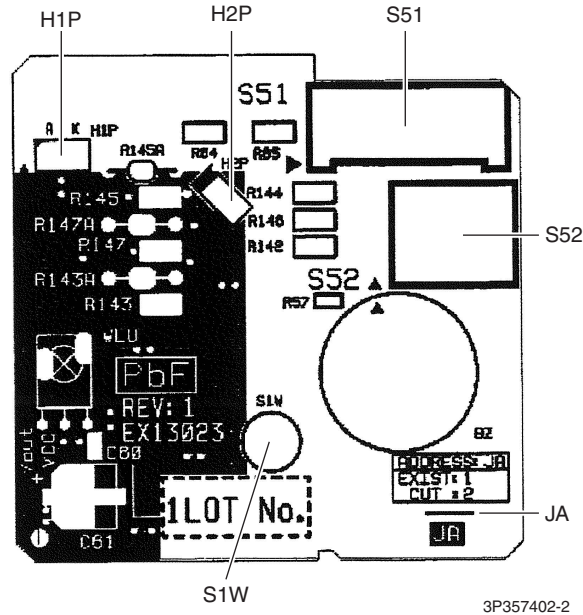

Caution

Replace the PCB if you accidentally cut a wrong jumper.
Jumpers are necessary for electronic circuit. Improper operation may occur if you cut any of them.

INTELLIGENT EYE Sensor PCB (A3P)

- 1) S36 Connector for control PCB (A1P)

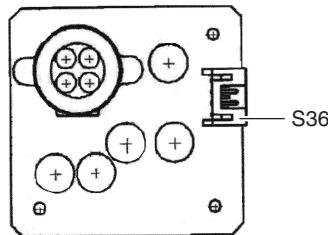

1.2 CTXS07LVJU, FTXS09/12LVJU

Control PCB (PCB1)

- | | |
|--------------------|--|
| 1) S1 | Connector for DC fan motor |
| 2) S21 | Connector for centralized control (HA) |
| 3) S25 | Connector for INTELLIGENT EYE sensor PCB (PCB4) |
| 4) S32 | Indoor heat exchanger thermistor |
| 5) S41 | Connector for swing motors |
| 6) S46 | Connector for display PCB (PCB3) |
| 7) S47 | Connector for signal receiver PCB (PCB2) |
| 8) H1, H2, H3, FG | Connector for terminal strip |
| 9) JA | Address setting jumper |
| | * Refer to page 216 for details. |
| 10) JB | Fan speed setting when compressor stops for thermostat OFF |
| | * Refer to page 218 for details. |
| 11) JC | Power failure recovery function (auto-restart) |
| | * Refer to page 218 for details. |
| 12) LED A | LED for service monitor (green) |
| 13) FU1 (F1U), FU2 | Fuse (3.15 A, 250 V) |
| 14) V1 | Varistor |

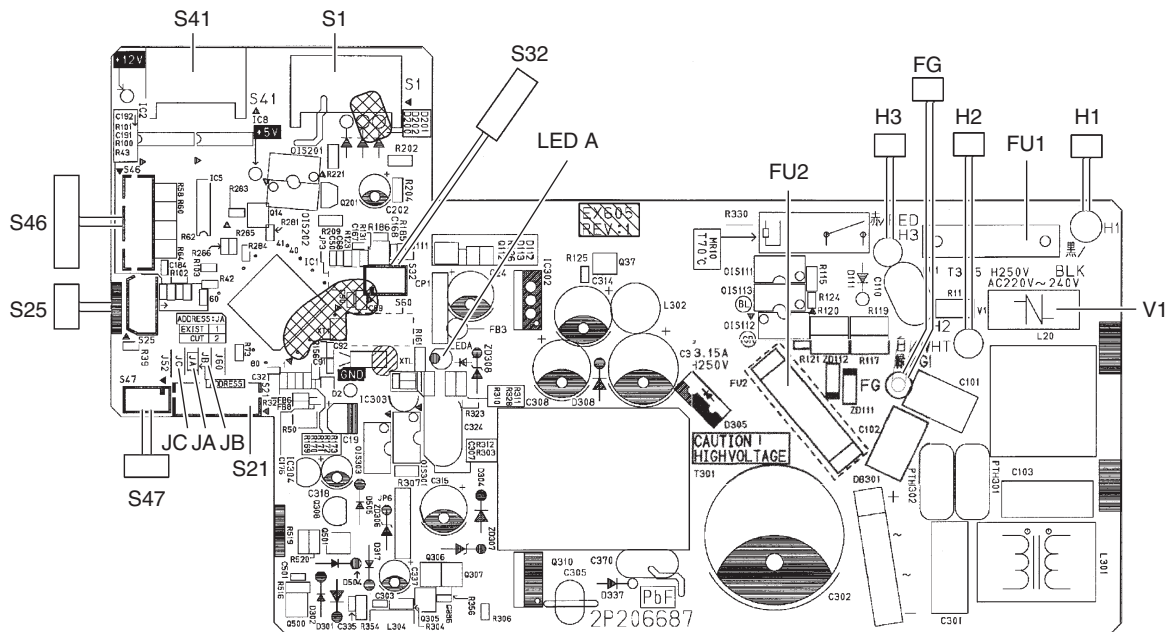

2P206687-4



Caution

Replace the PCB if you accidentally cut a wrong jumper.

Jumpers are necessary for electronic circuit. Improper operation may occur if you cut any of them.



Note:

The symbols in the parenthesis are the names on the appropriate wiring diagram.

Signal Receiver PCB (PCB2)

- 1) S48 Connector for control PCB (PCB1)

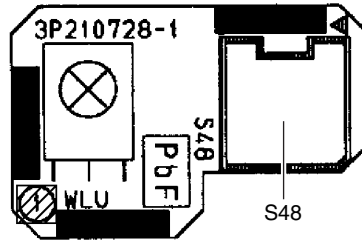

3P210728-1

Display PCB (PCB3)

- 1) S49 Connector for control PCB (PCB1)
- 2) SW1 Indoor unit **ON/OFF** button
- 3) LED1 (H1P) LED for operation (green)
- 4) LED2 (H2P) LED for timer (yellow)
- 5) LED3 (H3P) LED for INTELLIGENT EYE (green)
- 6) RTH1 (R1T) Room temperature thermistor

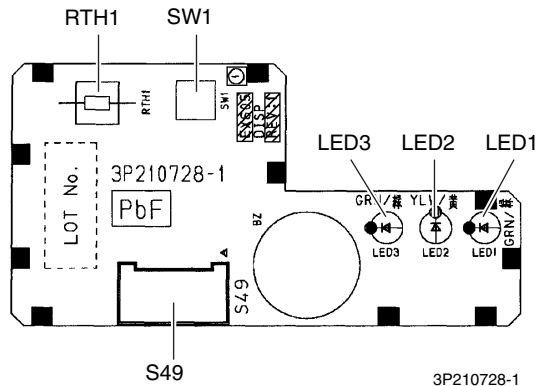

3P210728-1

INTELLIGENT EYE Sensor PCB (PCB4)

- 1) S26 Connector for control PCB (PCB1)

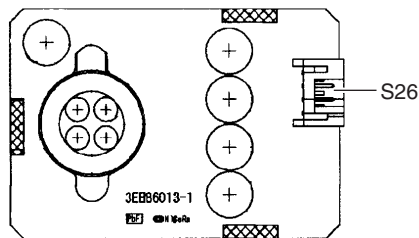

3EB86013-1



Note: The symbols in the parenthesis are the names on the appropriate wiring diagram.

1.3 FTXS15/18/24LVJU

Control PCB (PCB1)

- | | |
|-----------------------------|--|
| 1) S1 | Connector for DC fan motor |
| 2) S21 | Connector for centralized control (HA) |
| 3) S25 | Connector for INTELLIGENT EYE sensor PCB (PCB4) |
| 4) S32 | Indoor heat exchanger thermistor |
| 5) S41 | Connector for swing motors |
| 6) S46 | Connector for display PCB (PCB3) |
| 7) S47 | Connector for signal receiver PCB (PCB2) |
| 8) H1, H2, H3, FG | Connector for terminal strip |
| 9) JA | Address setting jumper |
| | * Refer to page 216 for details. |
| 10) JB | Fan speed setting when compressor stops for thermostat OFF |
| | * Refer to page 218 for details. |
| 11) JC | Power failure recovery function (auto-restart) |
| | * Refer to page 218 for details. |
| 12) LED A | LED for service monitor (green) |
| 13) FU1 (F1U),
FU2 (F2U) | Fuse (3.15 A, 250 V) |
| 14) V1 | Varistor |

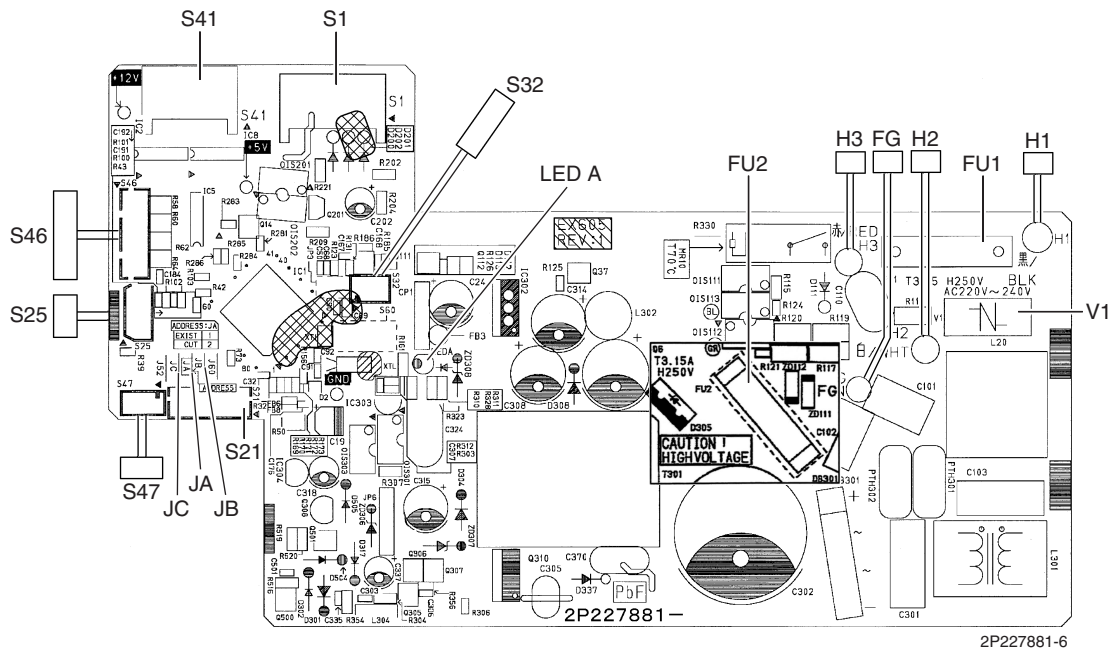

Caution

Replace the PCB if you accidentally cut a wrong jumper.

Jumpers are necessary for electronic circuit. Improper operation may occur if you cut any of them.



Note:

The symbols in the parenthesis are the names on the appropriate wiring diagram.

Signal Receiver PCB (PCB2)

- 1) S48 Connector for control PCB (PCB1)

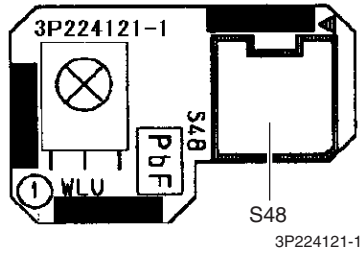

Display PCB (PCB3)

- 1) S49 Connector for control PCB (PCB1)
- 2) SW1 Indoor unit **ON/OFF** button
- 3) LED1 (H1P) LED for operation (green)
- 4) LED2 (H2P) LED for timer (yellow)
- 5) LED3 (H3P) LED for INTELLIGENT EYE (green)
- 6) RTH1 (R1T) Room temperature thermistor

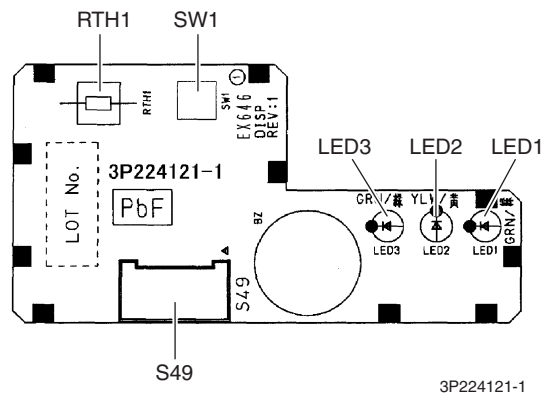

INTELLIGENT EYE Sensor PCB (PCB4)

- 1) S36 Connector for control PCB (PCB1)

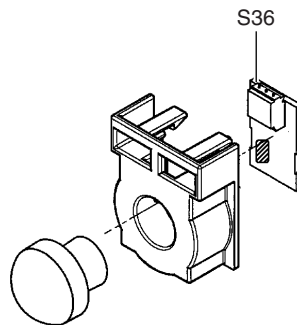

3P227885-1



Note: The symbols in the parenthesis are the names on the appropriate wiring diagram.

1.4 FDXS09/12LVJU, CDXS15/18/24LVJU

Control PCB (A1P)

- | | |
|---------------|--|
| 1) S1 | Connector for AC fan motor |
| 2) S7 | Connector for AC fan motor (Hall IC) |
| 3) S21 | Connector for centralized control (HA) |
| 4) S26 | Connector for display/signal receiver PCB (A2P) |
| 5) S32 | Connector for indoor heat exchanger thermistor |
| 6) H1, H2, H3 | Connector for terminal block |
| 7) FG (GND) | Connector for terminal block (ground) |
| 8) JA | Address setting jumper |
| | * Refer to page 216 for details. |
| 9) JB | Fan speed setting when compressor stops for thermostat OFF |
| | * Refer to page 218 for details. |
| 10) JC | Power failure recovery function (auto-restart) |
| | * Refer to page 218 for details. |
| 11) LED A | LED for service monitor (green) |
| 12) FU1 (F1U) | Fuse (3.15 A, 250 V) |
| 13) V1 | Varistor |

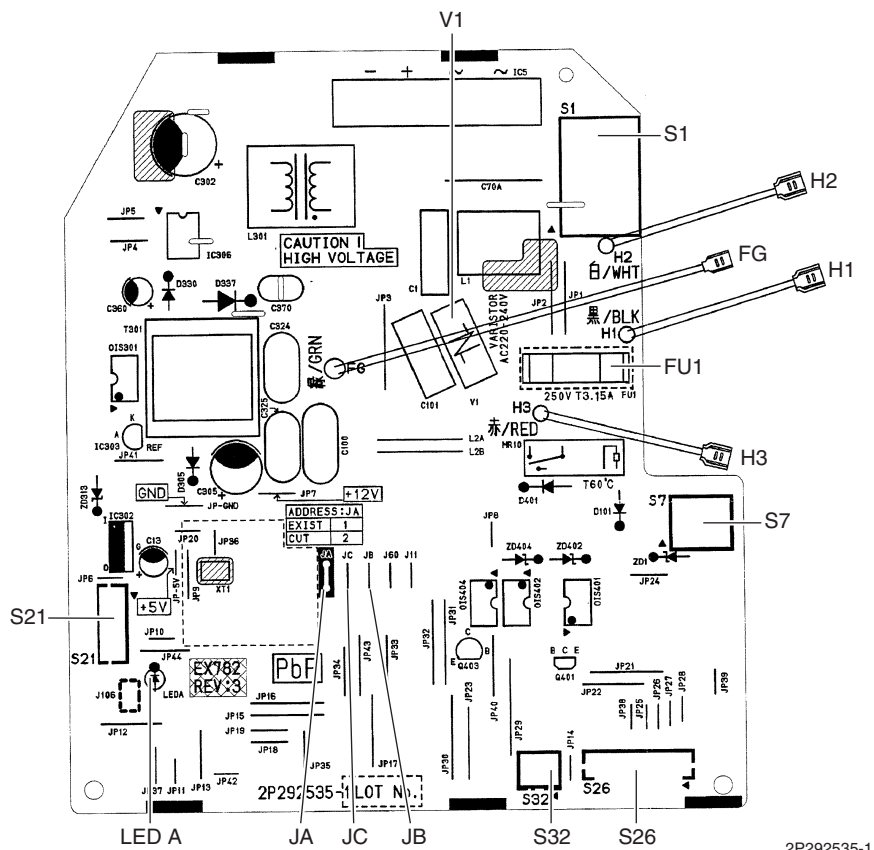

Caution

Replace the PCB if you accidentally cut a wrong jumper.

Jumpers are necessary for electronic circuit. Improper operation may occur if you cut any of them.



Note:

The symbols in the parenthesis are the names on the appropriate wiring diagram.

Display/Signal Receiver PCB (A2P)

- | | |
|---------------|----------------------------------|
| 1) S1 | Connector for control PCB (A1P) |
| 2) SW1 (S1W) | Indoor unit ON/OFF button |
| 3) LED2 (H2P) | LED for timer (yellow) |
| 4) LED3 (H3P) | LED for operation (green) |
| 5) RTH1 (R1T) | Room temperature thermistor |

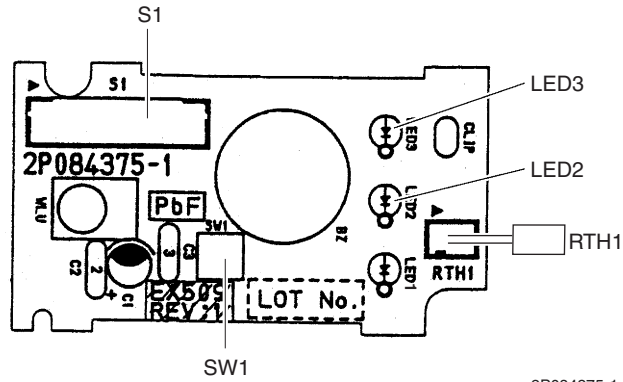

2P084375-1

★LED 1 does not function.



Note: The symbols in the parenthesis are the names on the appropriate wiring diagram.

1.5 FVXS09/12/15/18NVJU

Control PCB (PCB2)

- | | |
|-----------------------------|--|
| 1) S1 | Connector for DC fan motor |
| 2) S21 | Connector for centralized control (HA) |
| 3) S26 | Connector for service PCB (PCB3) |
| 4) S32 | Indoor heat exchanger thermistor |
| 5) S41 | Connector for lower air outlet motor |
| 6) S42 | Connector for swing motor |
| 7) S46 | Connector for display/signal receiver PCB (PCB4) |
| 8) S48 | Connector for sensor PCB (PCB1) |
| 9) H1, H2, H3 | Connector for terminal strip |
| 10) E1 | Terminal for ground wire |
| 11) JA | Address setting jumper |
| | * Refer to page 216 for details. |
| 12) JB | Fan speed setting when compressor stops for thermostat OFF |
| | * Refer to page 218 for details. |
| 13) JC | Power failure recovery function |
| | * Refer to page 218 for details. |
| 14) FU1 (F1U),
FU2 (F2U) | Fuse (3.15 A, 250 V) |
| 15) LED A | LED for service monitor (green) |
| 16) V1, V2 | Varistor |

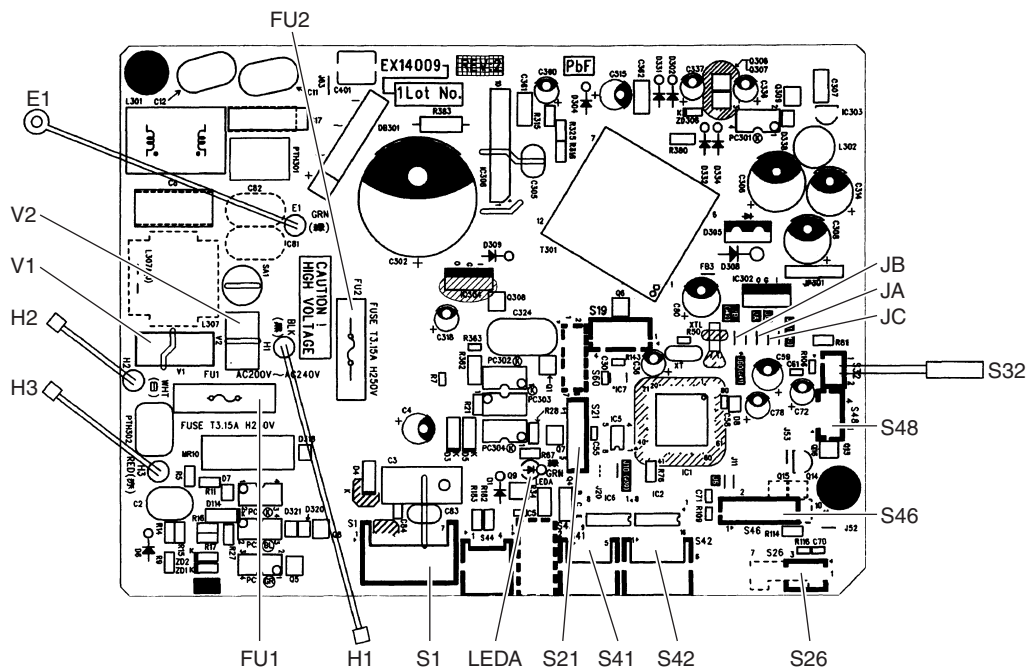

2P383711-1



Caution

Replace the PCB if you accidentally cut a wrong jumper.

Jumpers are necessary for electronic circuit. Improper operation may occur if you cut any of them.



Note:

The symbols in the parenthesis are the names on the appropriate wiring diagram.

**Sensor PCB
(PCB1)**

- 1) S49 Connector for control PCB (PCB2)
- 2) RTH2 (R1T) Room temperature thermistor

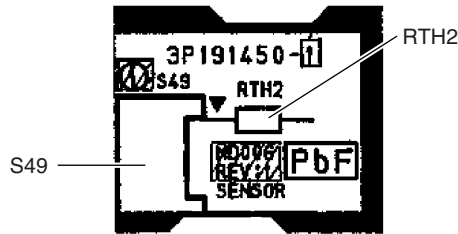

3P191450-1

**Service PCB
(PCB3)**

- 1) S27 Connector for control PCB (PCB2)
- 2) SW2 (S2W)-4 Switch for upward airflow limit setting
* Refer to page 218 for details.
* Keep the other switches as factory setting.
- 3) SW4 (S4W) Switch for airflow selection
* Refer to page 44 for details.

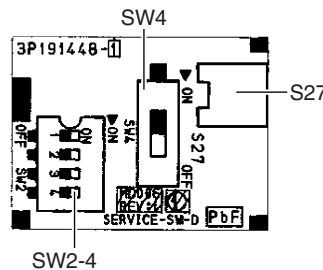

3P191448-1

**Display/Signal
Receiver PCB
(PCB4)**

- 1) S47 Connector for control PCB (PCB2)
- 2) SW1 (S1W) Indoor unit **ON/OFF** button
- 3) LED1 (H1P) LED for operation (green)
- 4) LED2 (H2P) LED for timer (yellow)

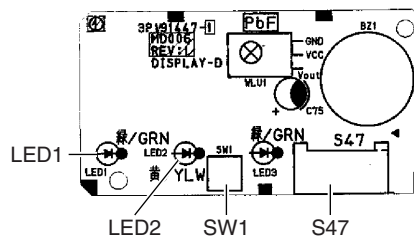

3P191447-1

★ LED3 does not function.



Note: The symbols in the parenthesis are the names on the appropriate wiring diagram.

1.6 FFQ09/12/15/18Q2VJU

Control PCB (A1P)

- | | |
|---------------|---|
| 1) X15A | Connector for float switch |
| 2) X16A | Connector for room temperature thermistor (suction air thermistor) |
| 3) X17A, X18A | Connector for indoor heat exchanger thermistor |
| 4) X20A | Connector for DC fan motor |
| 5) X24A | Connector for transmitter board
(when the wireless remote controller (option) is used) |
| 6) X25A | Connector for drain pump motor |
| 7) X27A | Connector for terminal block (for inter-unit wiring) |
| 8) X30A | Connector for terminal block (for wired remote controller) |
| 9) X33A | Connector for adaptor for wiring (option) |
| 10) X35A | Connector for wiring adaptor for electrical appendices (option) |
| 11) X36A | Connector for swing motors on decoration panel (option) |
| 12) X80A | Connector for decoration panel (BYFQ60B3W1) (option) |
| 13) X81A | Connector for sensor kit (BRYQ60A2W(S)) (option) |
| 14) HAP | LED for service monitor (green) |
| 15) DS1 | DIP switch |
| 16) F1U | Fuse (5A, 250V) |

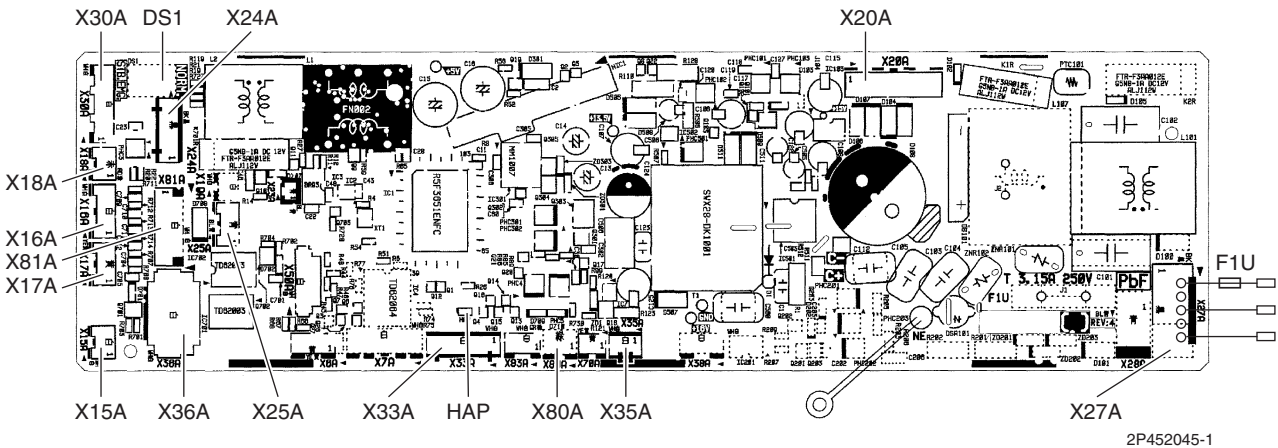

2. Wired Remote Controller

2.1 BRC1E73

**Wired Remote
Controller PCB**

- 1) P1, P2 Terminal for indoor unit
- 2) R4T Room temperature thermistor

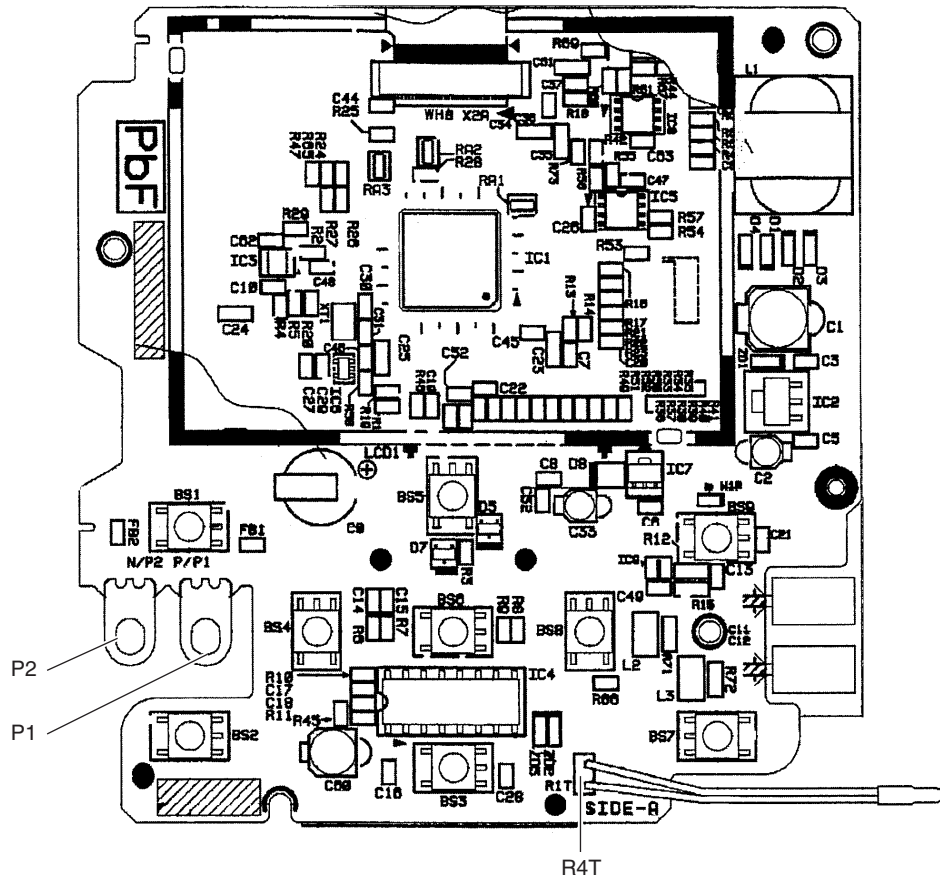

2P298037-7

3. Wireless Remote Controller Kit

3.1 BRC082A41W, BRC082A42W(S)

Transmitter Board (A2P)

- 1) X1A Connector for receiver (A3P)
- 2) X2A Connector for control PCB (A1P)
- 3) SS1 MAIN/SUB setting switch
* Refer to page 224 for details.
- 4) SS2 Address setting switch
* Refer to page 224 for details.

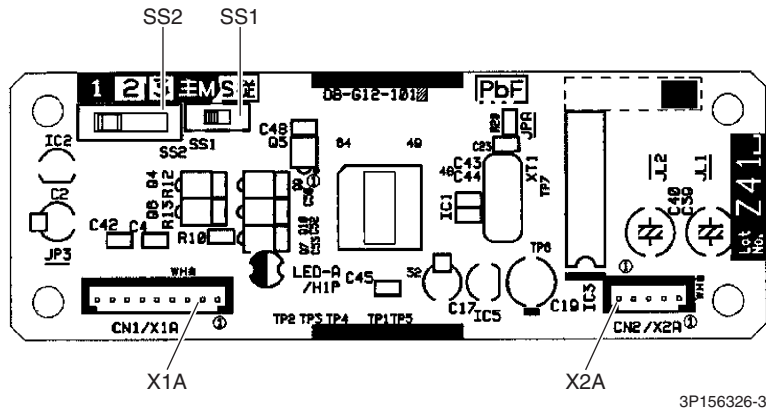

Receiver (A3P)

- 1) X1A Connector for transmitter board (A2P)
- 2) BS1 Emergency operation switch
- 3) LED1 (H1P) LED for operation (red)
- 4) LED2 (H2P) LED for timer (green)
- 5) LED3 (H3P) LED for filter cleaning sign (red)
- 6) LED4 (H4P) LED for defrost operation (orange)

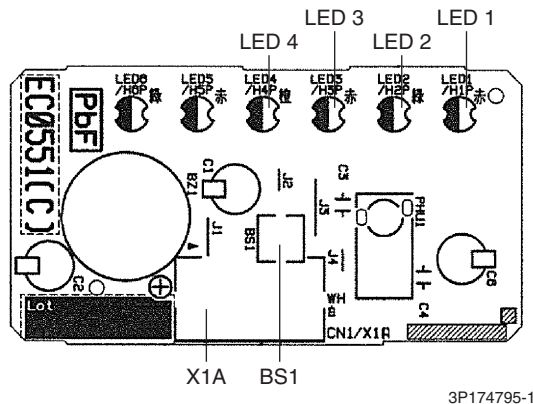

★ LED5 and LED6 do not function.

4. Outdoor Unit

Main PCB (PCB1)

1) S	Connector for terminal board (indoor - outdoor transmission)
2) S15	Connector for COOL/HEAT mode lock * Refer to page 213 for details.
3) S20 (white)	Connector for electronic expansion valve coil A port
4) S21 (red)	Connector for electronic expansion valve coil B port
5) S22 (blue)	Connector for electronic expansion valve coil C port (24/36 class)
6) S23 (yellow)	Connector for electronic expansion valve coil D port (36 class)
7) S40	Connector for overload protector
8) S70	Connector for DC fan motor
9) S80	Connector for four way valve coil
10) S90	Connector for thermistors (outdoor temperature, outdoor heat exchanger, discharge pipe)
11) S92	Connector for gas pipe thermistor
12) S93	Connector for liquid pipe thermistor
13) S201, S202	Connector for service monitor PCB (PCB2)
14) HL1, HN1	Connector for terminal strip (power supply)
15) E1, E2	Connector for ground wire
16) U, V, W	Connector for compressor
17) FU1, FU2	Fuse (3.15 A, 250 V)
18) FU3	Fuse (30 A, 250 V)
19) V2, V3, V401	Varistor

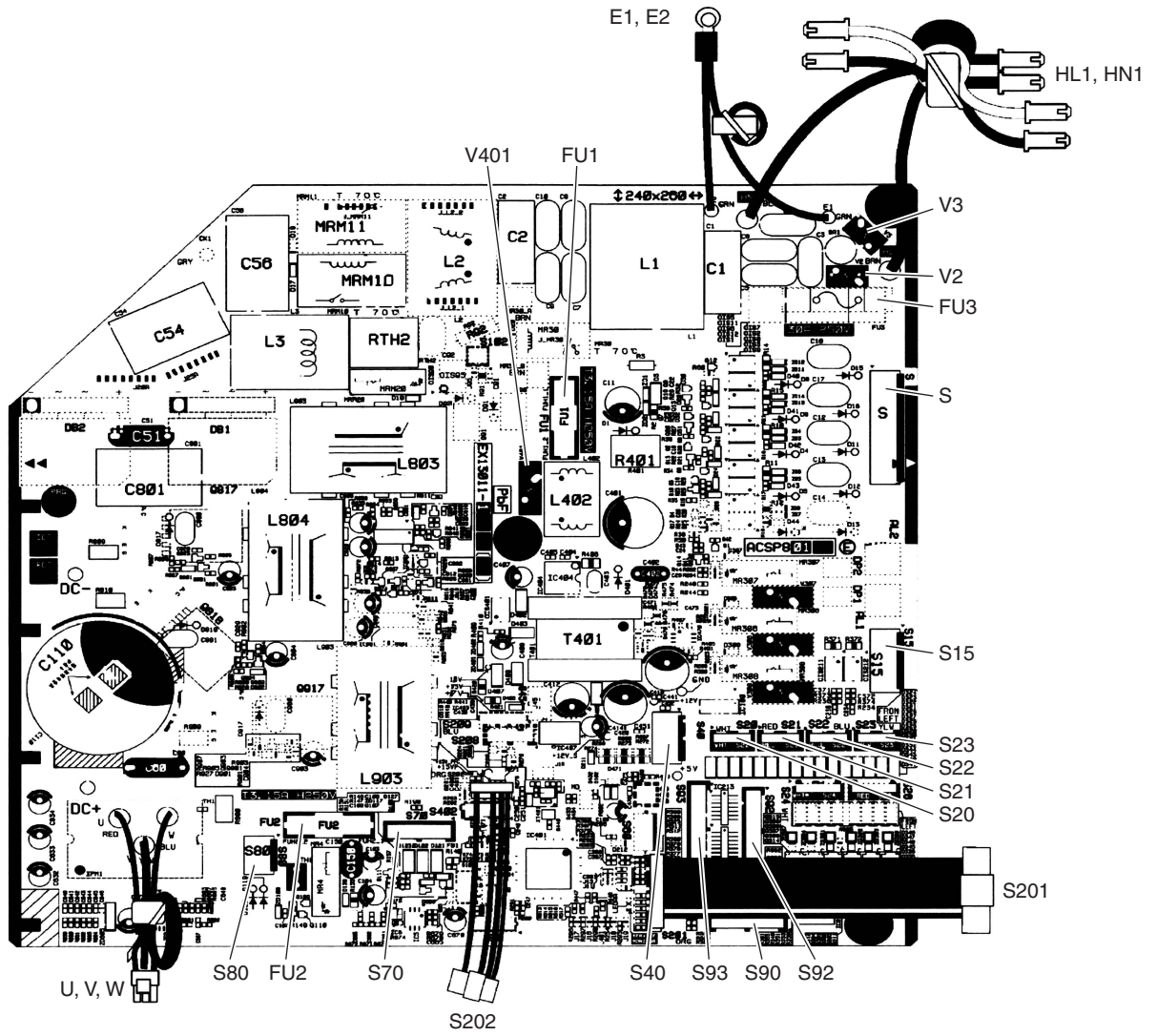

2P350358-10
2P350358-11

Service Monitor PCB (PCB2)

- | | |
|----------------|---|
| 1) S501, S502 | Connector for main PCB (PCB1) |
| 2) LED A | LED for service monitor (green) |
| 3) LED1 - LED5 | LED for service monitor (red) |
| 4) SW1 | Forced operation ON/OFF switch
* Refer to page 204 for details. |
| 5) SW2 | Operation mode switch
* Refer to page 204 for details. |
| 6) SW3 | Wiring error check switch
* Refer to page 205 for details. |
| 7) SW4 | Priority room setting switch
* Refer to page 212 for details. |
| 8) SW6-1 | NIGHT QUIET mode setting switch
* Refer to page 213 for details. |

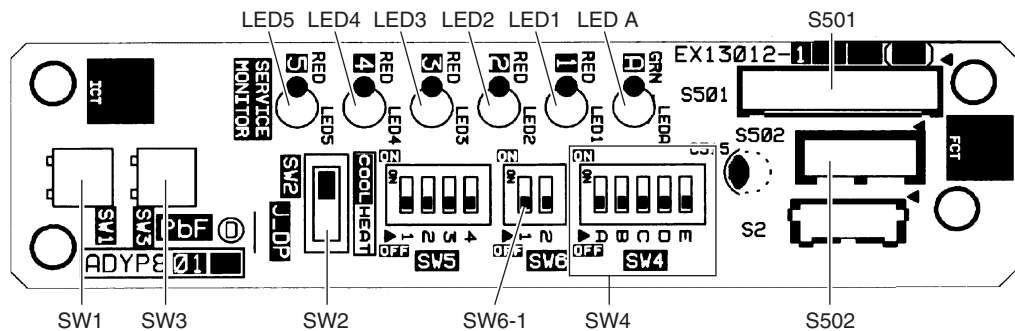

3P346711-10

★ SW6-2 and all the switches of SW5 have no function. Keep them OFF.

Part 4

Functions and Control

1. Common Functions	39
1.1 Temperature Control	39
1.2 Frequency Principle.....	39
2. CTXG, CTXS, FTXS, CDXS, FDXS, FVXS Series Functions.....	41
2.1 Airflow Direction Control.....	41
2.2 Fan Speed Control for Indoor Unit	45
2.3 Program Dry Operation	46
2.4 Automatic Operation.....	47
2.5 Thermostat Control.....	48
2.6 NIGHT SET Mode	49
2.7 ECONO Operation	50
2.8 2-Area INTELLIGENT EYE Operation	51
2.9 INTELLIGENT EYE Operation	53
2.10 POWERFUL Operation	54
2.11 Multi-Monitor Lamp/TIMER Lamp	55
2.12 Clock Setting	56
2.13 WEEKLY TIMER Operation	57
2.14 Other Functions.....	63
3. FFQ Series Functions	65
3.1 Airflow Direction Control.....	65
3.2 Fan Speed Control for Indoor Unit	65
3.3 Program Dry Operation	66
3.4 Clock and Calendar Setting (With Wired Remote Controller BRC1E73)	67
3.5 Schedule TIMER Operation (With Wired Remote Controller BRC1E73)	69
3.6 Setback Function (With Wired Remote Controller BRC1E73)	73
3.7 Drain Pump Control.....	73
3.8 Hot Start Control (In Heating Operation Only).....	75
3.9 Presence and Floor Sensors (Option).....	76
3.10 Other Functions.....	79
4. Control Specification	80
4.1 Thermistor Functions.....	80
4.2 Mode Hierarchy	82
4.3 Frequency Control.....	83
4.4 Controls at Mode Changing/Start-up.....	85
4.5 Discharge Pipe Temperature Control.....	86
4.6 Input Current Control.....	87
4.7 Freeze-up Protection Control	88
4.8 Heating Peak-cut Control	88
4.9 Outdoor Fan Control.....	89

4.10 Liquid Compression Protection Function.....	89
4.11 Defrost Control	90
4.12 Low Hz High Pressure Limit	91
4.13 Electronic Expansion Valve Control	92
4.14 Malfunctions	97

1. Common Functions

1.1 Temperature Control

Definitions of Temperatures

The definitions of temperatures are classified as following.

- ◆ Room temperature: temperature of lower part of the room
- ◆ Set temperature: temperature set by remote controller
- ◆ Room thermistor temperature: temperature detected by room temperature thermistor
- ◆ Target temperature: temperature determined by microcomputer

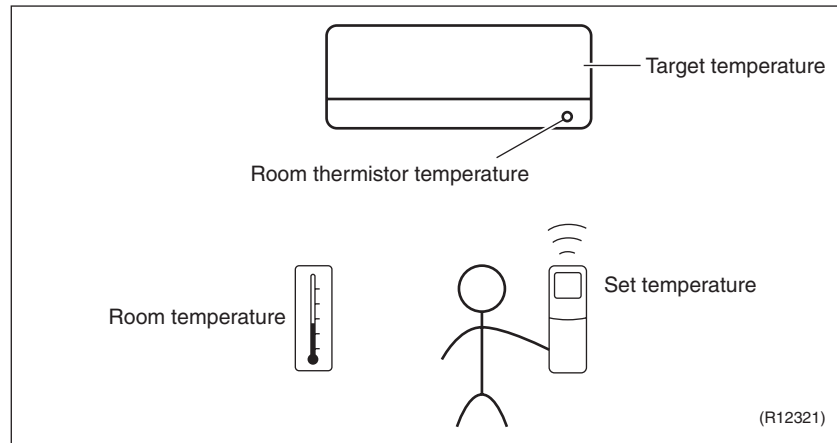

★ The illustration is for CTXS, FTXS series as representative.

Temperature Control

The temperature of the room is detected by the room temperature thermistor. However, there is difference between the temperature detected by room temperature thermistor and the temperature of lower part of the room, depending on the type of the indoor unit or installation condition. Practically, the temperature control is done by the target temperature appropriately adjusted for the indoor unit and the temperature detected by room temperature thermistor.

1.2 Frequency Principle

Control Parameters

The frequency of the compressor is controlled by the following 2 parameters:

- The load condition of the operating indoor unit
- The difference between the room thermistor temperature and the target temperature

The target frequency is adapted by additional parameters in the following cases:

- Frequency restrictions
- Initial settings
- Forced cooling operation

Inverter Principle

To regulate the capacity, a frequency control is needed. The inverter makes it possible to control the rotation speed of the compressor. The following table explains the inverter principle:

Phase	Description
1	The supplied AC power source is converted into the DC power source for the present.
2	The DC power source is reconverted into the three phase AC power source with variable frequency. <ul style="list-style-type: none"> ■ When the frequency increases, the rotation speed of the compressor increases resulting in an increase of refrigerant circulation. This leads to a larger amount of heat exchange per unit. ■ When the frequency decreases, the rotation speed of the compressor decreases resulting in a decrease of refrigerant circulation. This leads to a smaller amount of heat exchange per unit.

The following drawing shows a schematic view of the inverter principle:

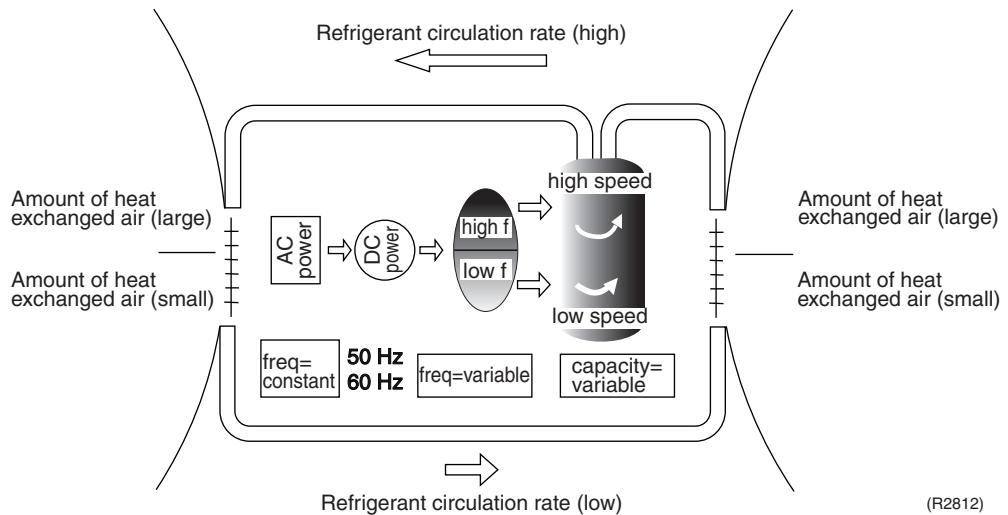

Inverter Features

The inverter provides the following features:

- The regulating capacity can be changed according to the changes in the outdoor temperature and cooling/heating load.
- Quick heating and quick cooling
The rotation speed of the compressor is increased when starting the heating (or cooling). This enables to reach the set temperature quickly.
- Even during extreme cold weather, high capacity is achieved. It is maintained even when the outdoor temperature is 2°C (35.6°F).
- Comfortable air conditioning
A fine adjustment is integrated to keep the room temperature constant.
- Energy saving heating and cooling
Once the set temperature is reached, the energy saving operation enables to maintain the room temperature at low power.

Frequency Limits

The following functions regulate the minimum and maximum frequency:

Frequency	Functions
Low	<ul style="list-style-type: none"> ■ Four way valve operation compensation. Refer to page 85.
High	<ul style="list-style-type: none"> ■ Compressor protection function. Refer to page 86. ■ Discharge pipe temperature control. Refer to page 86. ■ Input current control. Refer to page 87. ■ Freeze-up protection control. Refer to page 88. ■ Heating peak-cut control. Refer to page 88. ■ Defrost control. Refer to page 90.

Forced Cooling Operation

Refer to page 204 for details.

2. CTXG, CTXS, FTXS, CDXS, FDXS, FVXS Series Functions

2.1 Airflow Direction Control

Applicable Models	<p>CTXG09/12/18QVJUW(S) CTXS07LVJU FTXS09/12/15/18/24LVJU FVXS09/12/15/18NVJU</p>
Power-Airflow (Dual) Flap(s)	<p>The large flap sends a large volume of air downward to the floor and provides an optimum control in cooling, dry and heating operation.</p> <p>Cooling/Dry During cooling or dry operation, the flap retracts into the indoor unit. Then, cool air can be blown far and distributed all over the room.</p> <p>Heating During heating operation, the large flap directs airflow downward to spread the warm air to the entire room.</p>
Wide-Angle Louvers	<p>The louvers, made of elastic synthetic resin, provide a wide range of airflow that guarantees a comfortable air distribution.</p>



Auto-Swing

The following table explains the auto-swing process for cooling, dry, heating and fan:

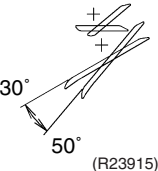
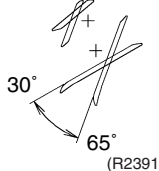
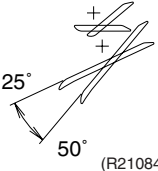
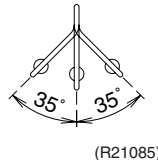
CTXG Series

	Flap (up and down)			Louver (right and left)
	Cooling/Dry	Heating	Fan	
09/12/18 class	 (R23915)	 (R23916)	 (R21084)	 (R21085)

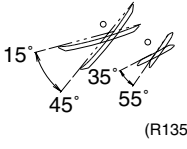
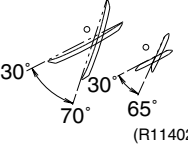
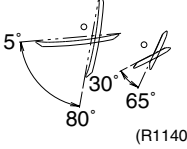
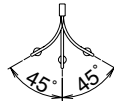
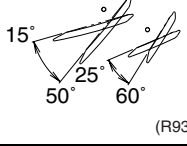
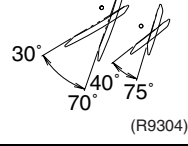
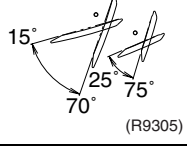
CTXS, FTXS Series

	Flap (up and down)			Louver (right and left)
	Cooling/Dry	Heating	Fan	
07/09/12 class	 (R13527)	 (R11402)	 (R11403)	 (R11404)
15/18/24 class	 (R9303)	 (R9304)	 (R9305)	 (R9306)

FVXS Series

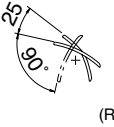
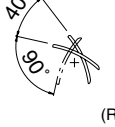
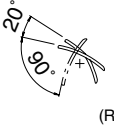
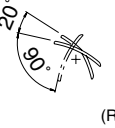
	Flap (up and down)	
	Cooling/Dry	Heating
Upward airflow limit OFF	 (R6831)	 (R6829)
Upward airflow limit ON	 (R6832)	 (R6830)

3-D Airflow**CTXG, CTXS, FTXS Series**

Alternative repetition of vertical and horizontal swing motions enables uniform air-conditioning of the entire room.

When the horizontal swing and vertical swing are both set to automatic operation, the airflow becomes 3-D airflow. The horizontal and vertical swing motions are alternated and the airflow direction changes in the order shown in the following diagram.

- (1) The louvers move from the right to the left.
- (2) The flaps move downward.
- (3) The louvers move from the left to the right.
- (4) The flaps move upward.

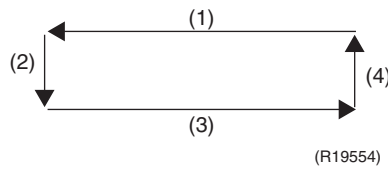
**COMFORT
AIRFLOW
Operation****CTXG, CTXS, FTXS Series**

The flaps are controlled not to blow the air directly at the people in the room.

The airflow will be in the upward direction while in cooling operation and in the downward direction while in heating operation, which will provide a comfortable wind that will not come in direct contact with people.

Airflow Selection Setting

FVXS Series

Airflow direction can be set with the airflow selection switch.

- Open the front panel.

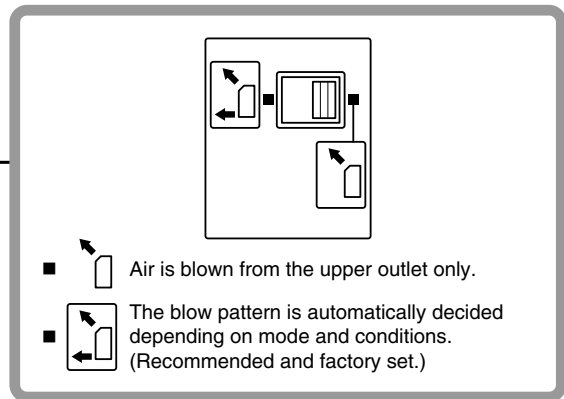
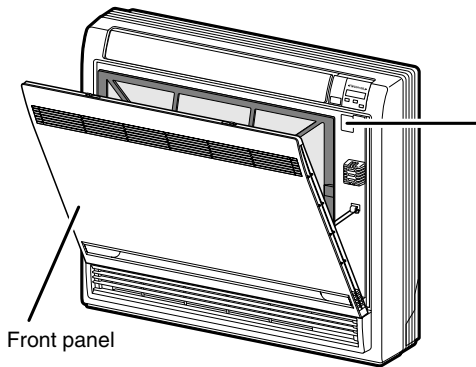

(R17866)



Caution:

Before opening the front panel, be sure to stop the operation and turn the breaker off. Do not touch the aluminum fins (indoor heat exchanger) inside of the indoor unit, as it may result in injury.

When setting the airflow selection switch to .

- The air conditioner automatically decides the appropriate blowing pattern depending on the operating mode/situation.

Operating mode	Situation	Blowing pattern
Cooling operation	When the room has become fully cool, or when 1 hour has passed since turning on the air conditioner.	Air is blown from the upper air outlet, so that air does not come into direct contact with people, and room temperature is equalized.
	At the start of operation or when the room is not fully cooled.	<p>(R17867)</p> <p>Air is blown from the upper and lower air outlets for high speed cooling during cooling operation, and for filling the room with warm air during heating operation.</p>
Heating operation	Normal time	
	At the start or when air temperature is low.	Air is blown from the upper air outlet, so that air does not come into direct contact with people.

- During dry operation, air is blown upper air outlet, so that cold air does not come into direct contact with people.

When setting the airflow selection switch to .

- Regardless of the operating mode or situation, air is blown from the upper air outlet.
- Use this switch when you do not want air coming out of the lower air outlet (e.g., while sleeping).

2.2 Fan Speed Control for Indoor Unit

Outline

Phase control and fan speed control contains 9 steps: LLL, LL, SL, L, ML, M, MH, H, and HH. The airflow rate can be automatically controlled depending on the difference between the room thermistor temperature and the target temperature.

Automatic Fan Speed Control

In automatic fan speed control, the step SL is not available.

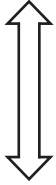
Step	Cooling	Heating
LLL	 (R11681)	 (R6834)
LL		
L		
ML		
M		
MH		
H		
HH (POWERFUL)		

 = The fan rate is automatically controlled within this range when **FAN** button is set to automatic.

Cooling

The following drawing explains the principle of fan speed control for cooling.

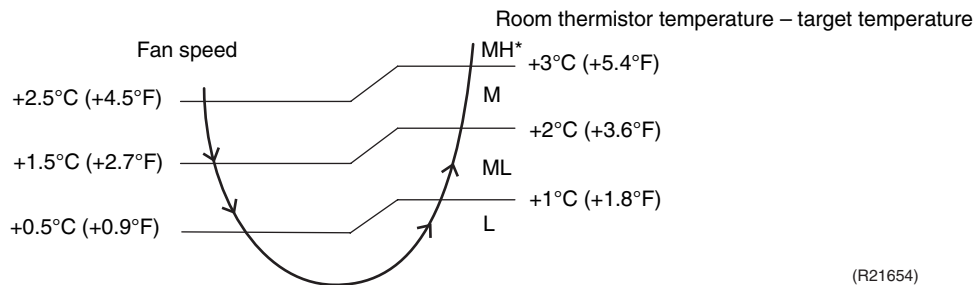

*The POWER limit is M tap in 30 minutes from the operation start.

Heating

In heating operation, the fan speed is regulated according to the indoor heat exchanger temperature and the difference between the room thermistor temperature and the target temperature.



Note: The fan stops during defrost operation.

COMFORT AIRFLOW Operation

CTXG, CTXS, FTXS Series

- The fan speed is controlled automatically within the following steps.

Cooling

L tap ~ MH tap (same as AUTOMATIC)

Heating

In order to obtain a comfortable airflow, the fan speed may be set to a rate different from automatic fan speed control.

- The latest command has the priority between POWERFUL and COMFORT AIRFLOW.

2.3 Program Dry Operation

Outline Program dry operation removes humidity while preventing the room temperature from lowering. Since the microcomputer controls both the temperature and airflow rate, the temperature adjustment and **FAN** setting buttons are inoperable.

Details The microcomputer automatically sets the temperature and airflow rate. The difference between the room thermistor temperature at start-up and the target temperature is divided into two zones. Then, the unit operates in an appropriate capacity for each zone to maintain the temperature and humidity at a comfortable level.

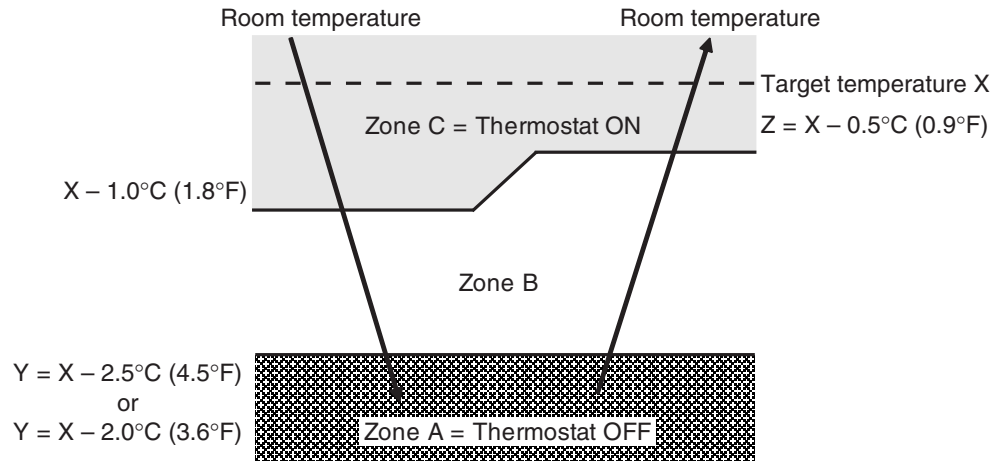

(R24029)

Room thermistor temperature at start-up	Target temperature X	Thermostat OFF point Y	Thermostat ON point Z ★
24°C or more (75.2°F or more)	Room thermistor temperature at start-up	X - 2.5°C (X - 4.5°F)	X - 0.5°C (X - 0.9°F)
18 ~ 23.5°C (64.4 ~ 74.3°F)		X - 2.0°C (X - 3.6°F)	X - 0.5°C (X - 0.9°F)
17.5°C or less (63.5°F or less)	18°C (64.4°F)	X - 2.0°C (X - 3.6°F)	X - 0.5°C = 17.5°C (X - 0.9°F = 63.5°F)

★ Thermostat turns on also when the room temperature is in the zone B for 10 minutes.

2.4 Automatic Operation

Outline

Automatic Cooling/Heating Function

When the automatic operation is selected with the remote controller, the microcomputer automatically determines the operation mode as cooling or heating according to the room temperature and the set temperature at start-up.

The unit automatically switches the operation mode to maintain the room temperature at the set temperature.

Details

Ts: set temperature (set by remote controller)
 Tt: target temperature (determined by microcomputer)
 Tr: room thermistor temperature (detected by room temperature thermistor)
 C: correction value

- The set temperature (Ts) determines the target temperature (Tt).
 (Ts = 18 ~ 30°C, 64.4 ~ 86°F).
- The target temperature (Tt) is calculated as:
 $Tt = Ts + C$
 where C is the correction value.
 $C = 0^\circ\text{C} (0^\circ\text{F})$
- Thermostat ON/OFF point and operation mode switching point are as follows:
 - Heating → Cooling switching point:
 $Tr \geq Tt + 3.0^\circ\text{C} (+5.4^\circ\text{F})$ (CTXG, CTXS, FTXS series)
 $Tr \geq Tt + 2.5^\circ\text{C} (+4.5^\circ\text{F})$ (CDXS, FDXS, FVXS series)
 - Cooling → Heating switching point:
 $Tr < Tt - 2.5^\circ\text{C} (-4.5^\circ\text{F})$ (CTXG series)
 $Tr < Tt - 3.0^\circ\text{C} (-5.4^\circ\text{F})$ (CTXS, FTXS, CDXS, FDXS, FVXS series)
 - Thermostat ON/OFF point is the same as the ON/OFF point of cooling or heating operation.
- During initial operation
 $Tr \geq Ts$: Cooling operation
 $Tr < Ts$: Heating operation

CTXG series

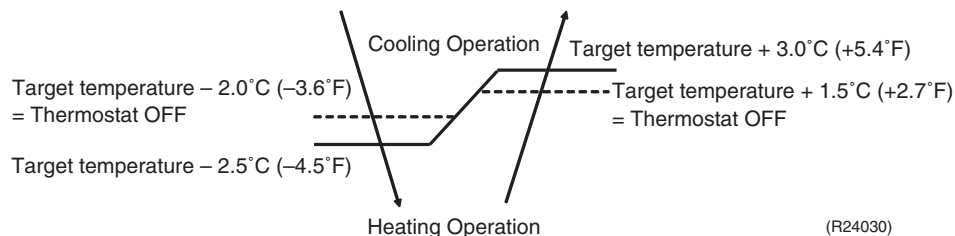

Ex: When the target temperature is 25°C (77°F)

Cooling → 23°C (73.4°F): Thermostat OFF → 22.5°C (72.5°F): Switch to heating

Heating → 26.5°C (79.7°F): Thermostat OFF → 28°C (82.4°F): Switch to cooling

CTXS, FTXS series

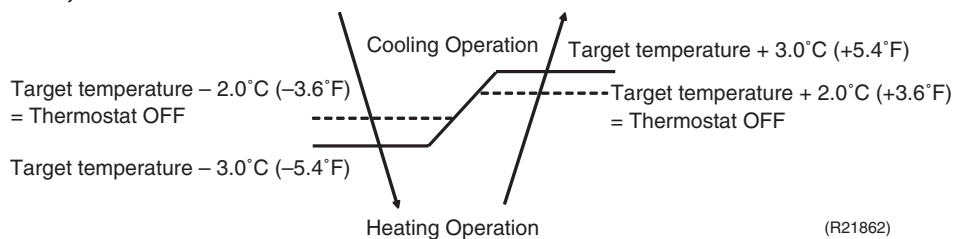

Ex: When the target temperature is 25°C (77°F)

Cooling → 23°C (73.4°F): Thermostat OFF → 22°C (71.6°F): Switch to heating

Heating → 27°C (80.6°F): Thermostat OFF → 28°C (82.4°F): Switch to cooling

CDXS, FDXS, FVXS series

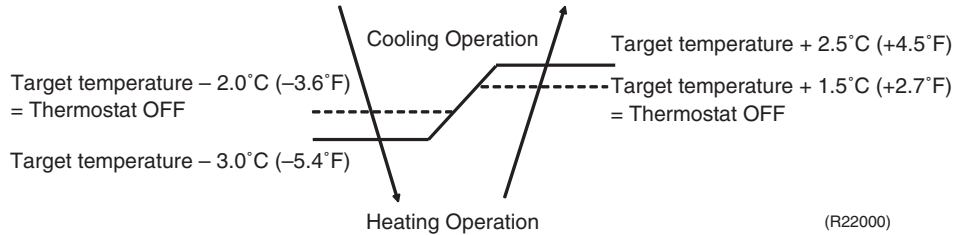

Ex: When the target temperature is 25°C (77°F)
 Cooling → 23°C (73.4°F): Thermostat OFF → 22°C (71.6°F): Switch to heating
 Heating → 26.5°C (79.7°F): Thermostat OFF → 27.5°C (81.5°F): Switch to cooling

2.5 Thermostat Control

Outline

Thermostat control is based on the difference between the room thermistor temperature and the target temperature.

Details

Thermostat OFF Condition

- The temperature difference is in the zone A.

Thermostat ON Conditions

- The temperature difference returns to the zone C after being in the zone A.
- The system resumes from defrost control in any zones except A.
- The operation turns on in any zones except A.
- The monitoring time has passed while the temperature difference is in the zone B.
 (Cooling: 10 minutes, Heating: 10 seconds)

Cooling

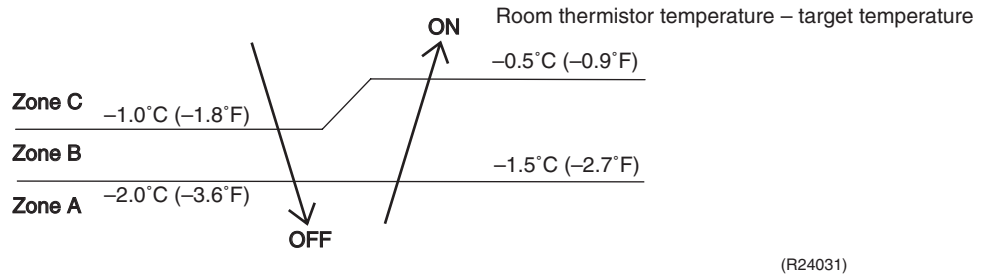

Heating CTXG series

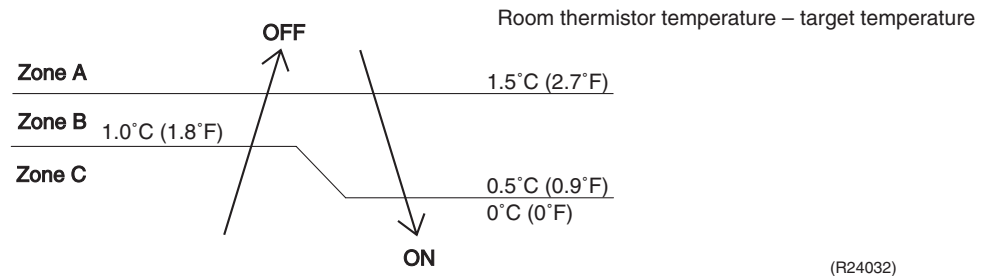

CTXS, FTXS series

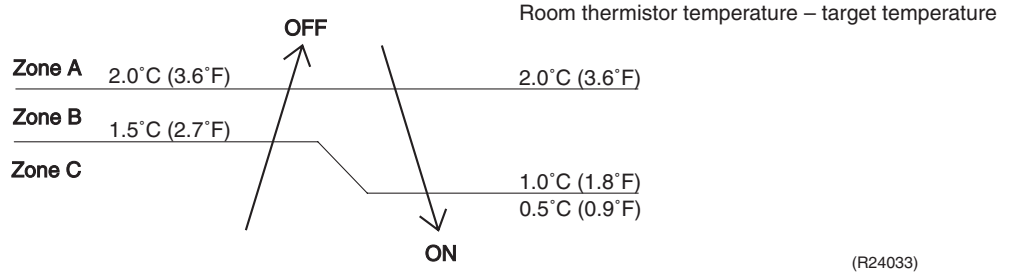

(R24033)

CDXS, FDXS, FVXS series

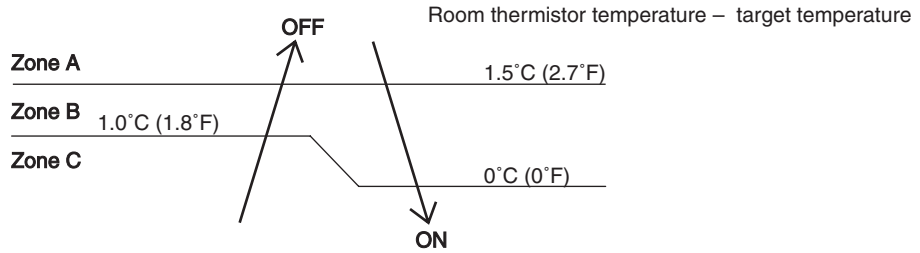

(R24034)



Refer to Temperature Control on page 39 for details.

2.6 NIGHT SET Mode

Outline

When the OFF TIMER is set, NIGHT SET Mode is automatically activated. NIGHT SET Mode keeps the airflow rate setting.

Details

NIGHT SET Mode continues operation at the target temperature for the first one hour, then automatically raises the target temperature slightly in cooling, or lowers it slightly in heating. This prevents excessive cooling or heating to ensure comfortable sleeping conditions, and also conserves electricity.

Cooling

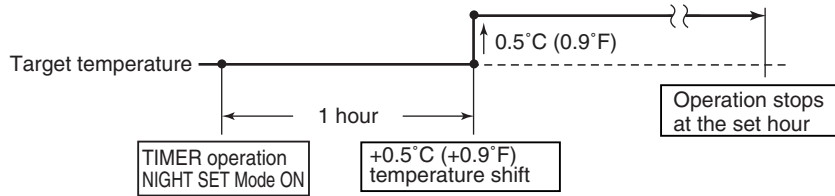

(R23917)

Heating

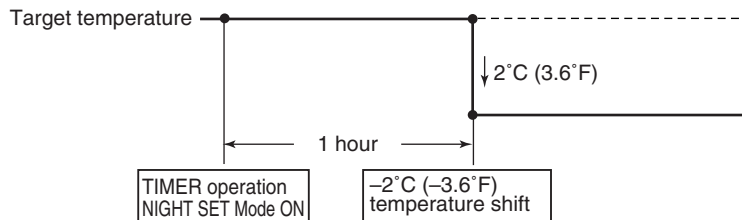

(R23918)

2.7 ECONO Operation

Applicable Models
 CTXG09/12/18QVJUW(S)
 CTXS07LVJU
 FTXS09/12/15/18/24LVJU
 FDXS09/12LVJU
 CDXS15/18/24LVJU
 FVXS09/12/15/18NVJU

Outline
 ECONO operation reduces the maximum operating current and the power consumption. This operation is particularly convenient for energy-saving. It is also a major bonus when breaker capacity does not allow the use of multiple electrical devices and air conditioners. It can be easily activated by pressing **ECONO** button on the wireless remote controller.

- Details**
- When this function is activated, the maximum capacity also decreases.
 - The remote controller can send the ECONO command when the unit is in cooling, heating, dry, or automatic operation. This function can only be set when the unit is running. Press **ON/OFF** button on the remote controller to cancel the function.
 - This function and POWERFUL operation cannot be used at the same time. The latest command has the priority.

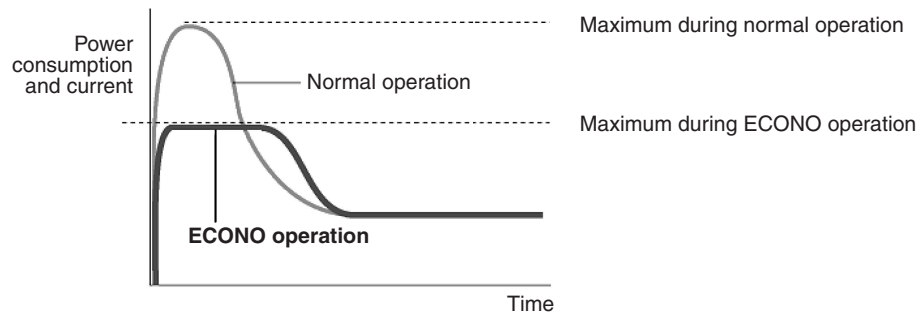

(R22012)

2.8 2-Area INTELLIGENT EYE Operation

Applicable Models CTXG09/12/18QVJUW(S)

Outline The following functions can be performed by the microcomputer with a motion sensor.

1. Reduction of the capacity when there is nobody in the room in order to save electricity (energy saving operation)
2. Dividing the room into plural areas and detecting presence of humans in each area.
Moving the airflow direction to the area with no human automatically to avoid direct airflow on humans.

Details 1. INTELLIGENT EYE detection method

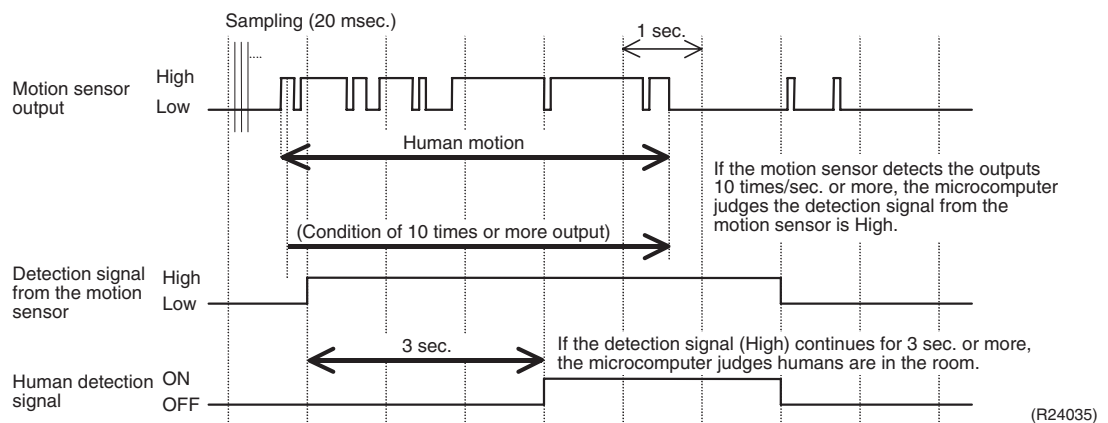

- The motion sensor detects human motion by receiving infrared rays and sends the pulse wave output.
- The microcomputer in the indoor unit carries out a sampling every 20 msec. If the motion sensor detects 10 times or more of the wave output in one second in total, and the High signal continues for 3 sec., the microcomputer judges humans are in the room as the human detection signal is ON.
- 2-area INTELLIGENT EYE motion sensor divides the area into 2 and detects presence of humans in each area.

Image of 2-area INTELLIGENT EYE

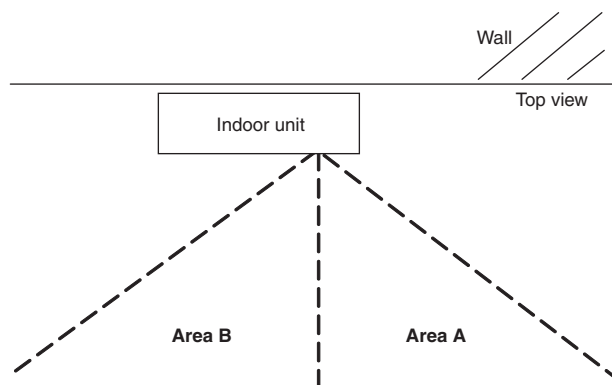

A microcomputer judges human presence by the human detection signal from each area A and B.

(R22951)

2. Motions (in cooling)

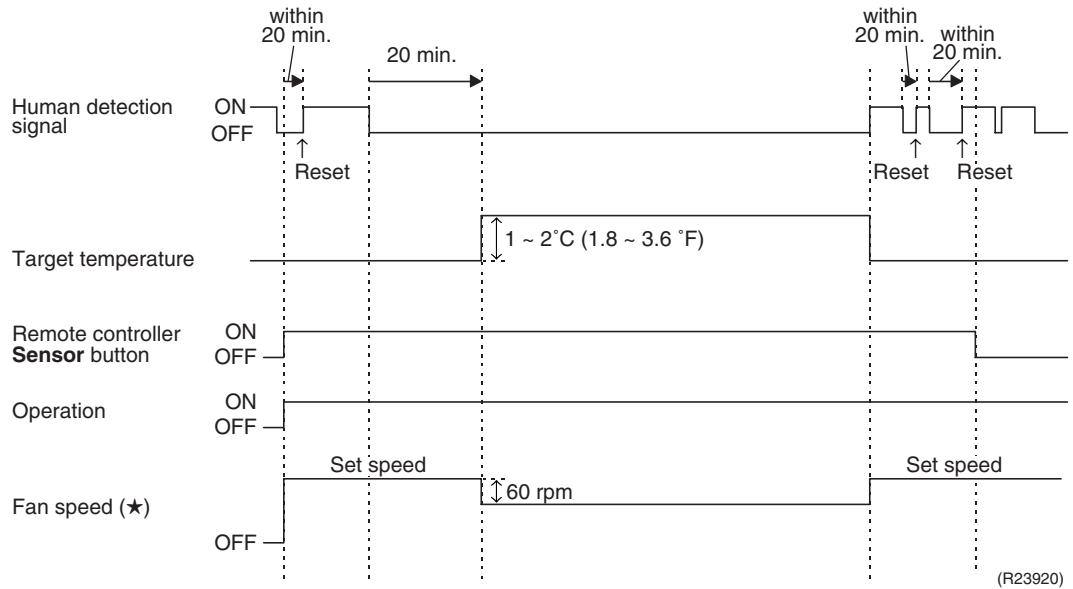

★ In FAN operation, the fan speed is reduced by 60 rpm when no one is in the area.

- When there is no signal from the motion sensor in 20 minutes, the microcomputer judges that nobody is in the room and operates the unit at a temperature shifted from the target temperature. (Cooling/Dry: 1 ~ 2°C (1.8 ~ 3.6°F) higher, Heating: 2°C (3.6°F) lower, Auto: according to the operation mode at that time.)

3. Airflow direction in 2-area INTELLIGENT EYE operation

- Detection method: The opposite area of detected area is set as the target direction.

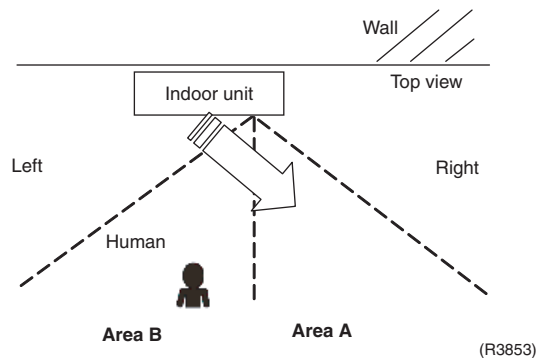

1. Human detection signal ON in both area A and B: Shift the airflow direction to area B (left side)
2. Human detection signal ON in area A: Shift the airflow direction to area B (left side)
3. Human detection signal ON in area B: Shift the airflow direction to area A (right side)
4. Human detection signal OFF in both area A and B: No change

*When the human detection signal is OFF for 20 minutes in both area A and B, the unit starts energy saving operation.



Note: For dry operation, the target temperature is shifted internally. The temperature cannot be set with the remote controller.

2.9 INTELLIGENT EYE Operation

Applicable Models

CTXS07LVJU
FTXS09/12/15/18/24LVJU

Outline

The microcomputer detects the presence of humans in the room with a motion sensor and reduces the capacity when there is nobody in the room in order to save electricity.

Details

1. INTELLIGENT EYE detection method

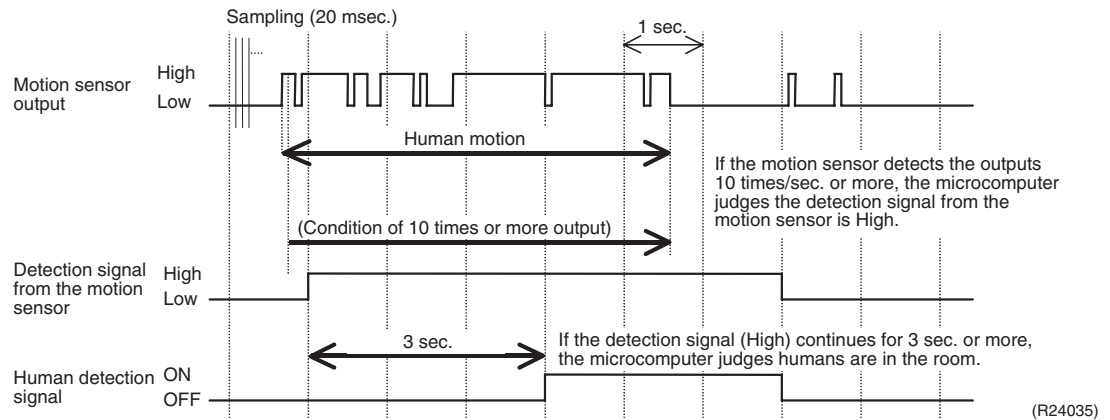

- The motion sensor detects human motion by receiving infrared rays and sends the pulse wave output.
- The microcomputer in the indoor unit carries out a sampling every 20 msec. If the motion sensor detects 10 times or more of the wave output in one second in total, and the High signal continues for 3 sec., the microcomputer judges humans are in the room as the human detection signal is ON.

2. Motions (in cooling)

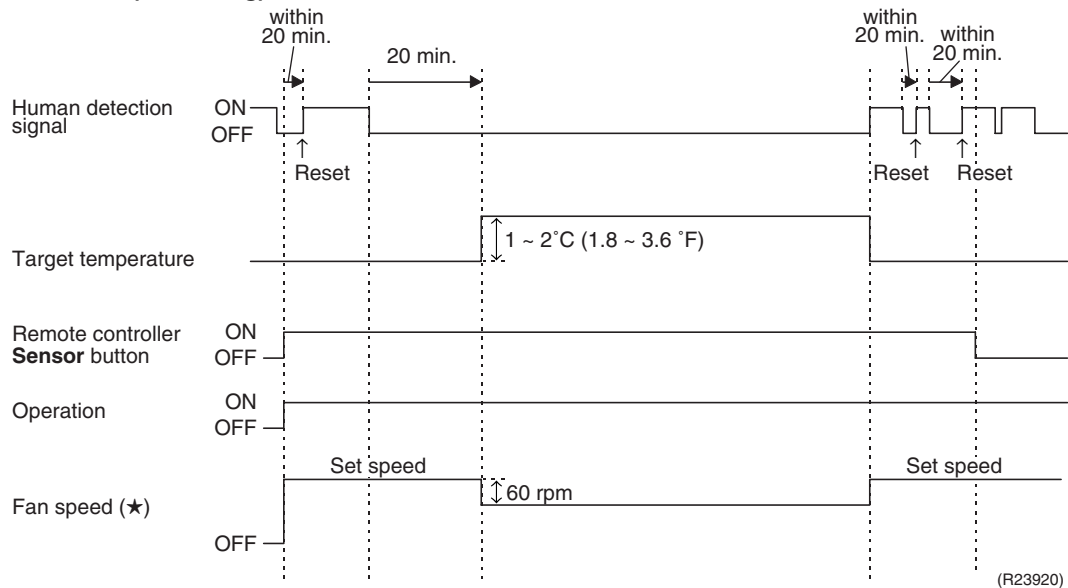

- ★ In FAN operation, the fan speed is reduced by 60 rpm when no one is in the area.
- When there is no signal from the motion sensor in 20 minutes, the microcomputer judges that nobody is in the room and operates the unit at a temperature shifted from the target temperature. (Cooling/Dry: 1 ~ 2°C (1.8 ~ 3.6°F) higher, Heating: 2°C (3.6°F) lower, Auto: according to the operation mode at that time.)



Note: For dry operation, the target temperature is shifted internally. The temperature cannot be set with the remote controller.

2.10 POWERFUL Operation

Outline

In order to exploit the cooling and heating capacity to full extent, the air conditioner can be operated by increasing the indoor fan rotating speed and the compressor frequency.

Details

When **POWERFUL** button is pressed, the fan speed and target temperature are converted to the following states for 20 minutes.

Operation mode	Fan speed	Target temperature
COOL	H tap + A rpm	18°C (64.4°F)
DRY	Dry rotating speed + A rpm	Lowered by 2 ~ 2.5°C (3.6 ~ 4.5°F)
HEAT	H tap + A rpm	30 ~ 31.5°C (86 ~ 88.7°F)
FAN	H tap + A rpm	—
AUTO	Same as cooling/heating in POWERFUL operation	The target temperature is kept unchanged.

A = 50 ~ 90 rpm (depending on the model)

Ex: POWERFUL operation in cooling

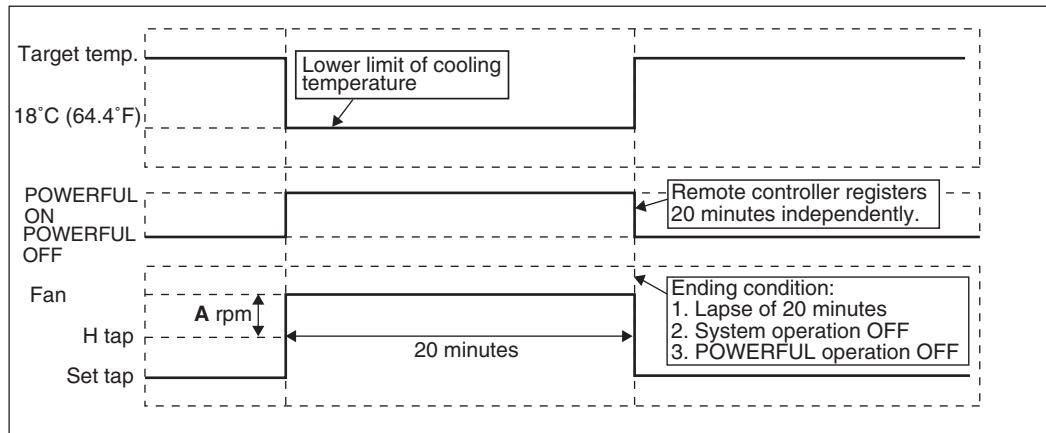

(R24589)



Note: POWERFUL operation cannot be used together with ECONO, COMFORT AIRFLOW or OUTDOOR UNIT QUIET operation.

2.11 Multi-Monitor Lamp/TIMER Lamp

Applicable Models CTXG09/12/18QVJUW(S)

Features Current operation mode is displayed in color of the lamp of the indoor unit. Operating status can be monitored even in automatic operation in accordance with the actual operation mode.

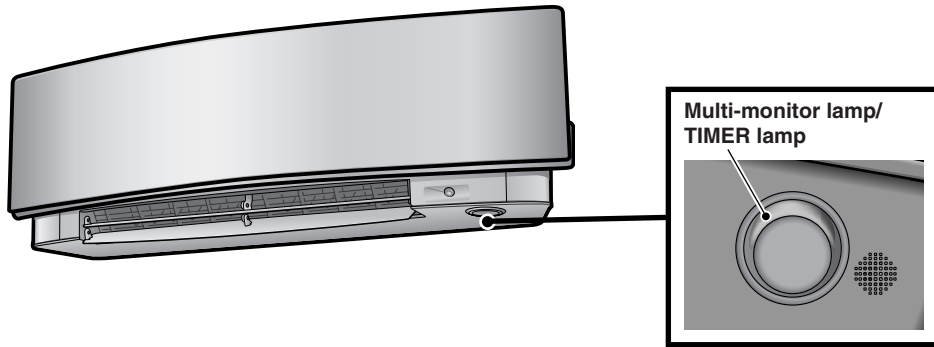

(R19925)

The lamp color changes according to the operation.

- * AUTORed/Blue
- * DRYGreen
- * COOL.....Blue
- * HEATRed
- * FAN.....White
- * TIMER.....Orange

Brightness Setting Each time **Brightness** button on the remote controller is pressed, the brightness of the multi-monitor lamp/TIMER lamp changes to high, low, or off.

2.12 Clock Setting

ARC452 Series
ARC466 Series

The clock can be set by taking the following steps:

1. Press **CLOCK** button.
 → 0:00 is displayed. MON and ☉ blink.
2. Press **SELECT ▲** or **SELECT ▼** button to set the clock to the current day of the week.
3. Press **CLOCK** button.
 → ☉ blinks.
4. Press **SELECT ▲** or **SELECT ▼** button to adjust the clock to the present time.
 Holding down **SELECT ▲** or **SELECT ▼** button increases or decreases the time display rapidly.
5. Press **CLOCK** button to set the clock. (Point the remote controller at the indoor unit when pressing the button.)
 → : blinks and clock setting is completed.

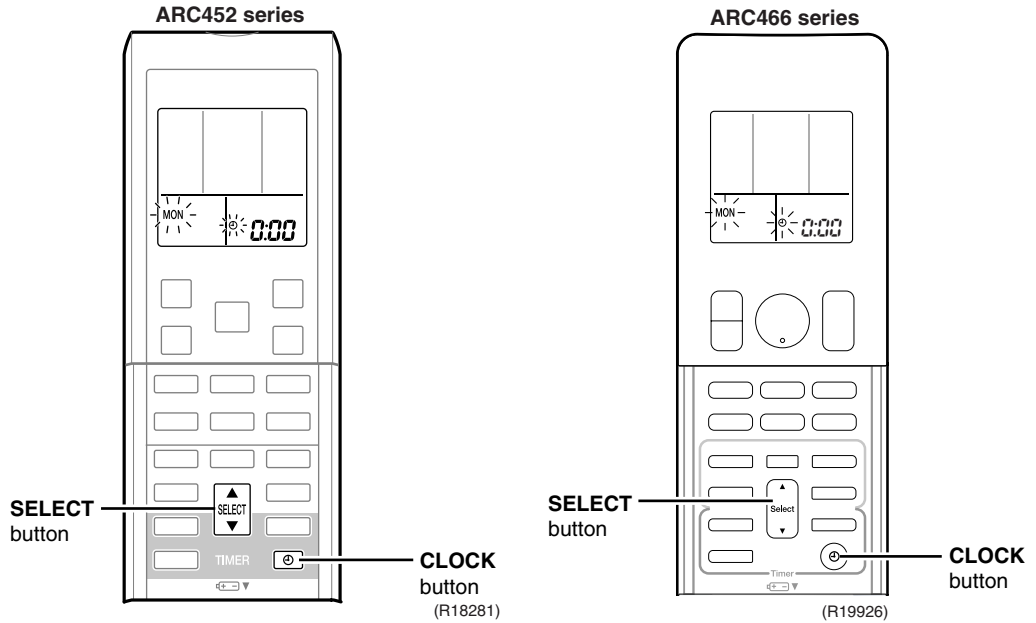

2.13 WEEKLY TIMER Operation

Applicable Models
 CTXG09/12/18QVJUW(S)
 CTXS07LVJU
 FTXS09/12/15/18/24LVJU
 FVXS09/12/15/18NVJU

Outline
 Up to 4 timer settings can be saved for each day of the week (up to 28 settings in total).
 The 3 items: ON/OFF, temperature, and time can be set.

Details
 ★ The illustrations are for CTXG series as representative.

Setting example of the WEEKLY TIMER

The same timer settings are used from Monday through Friday, while different timer settings are used for the weekend.

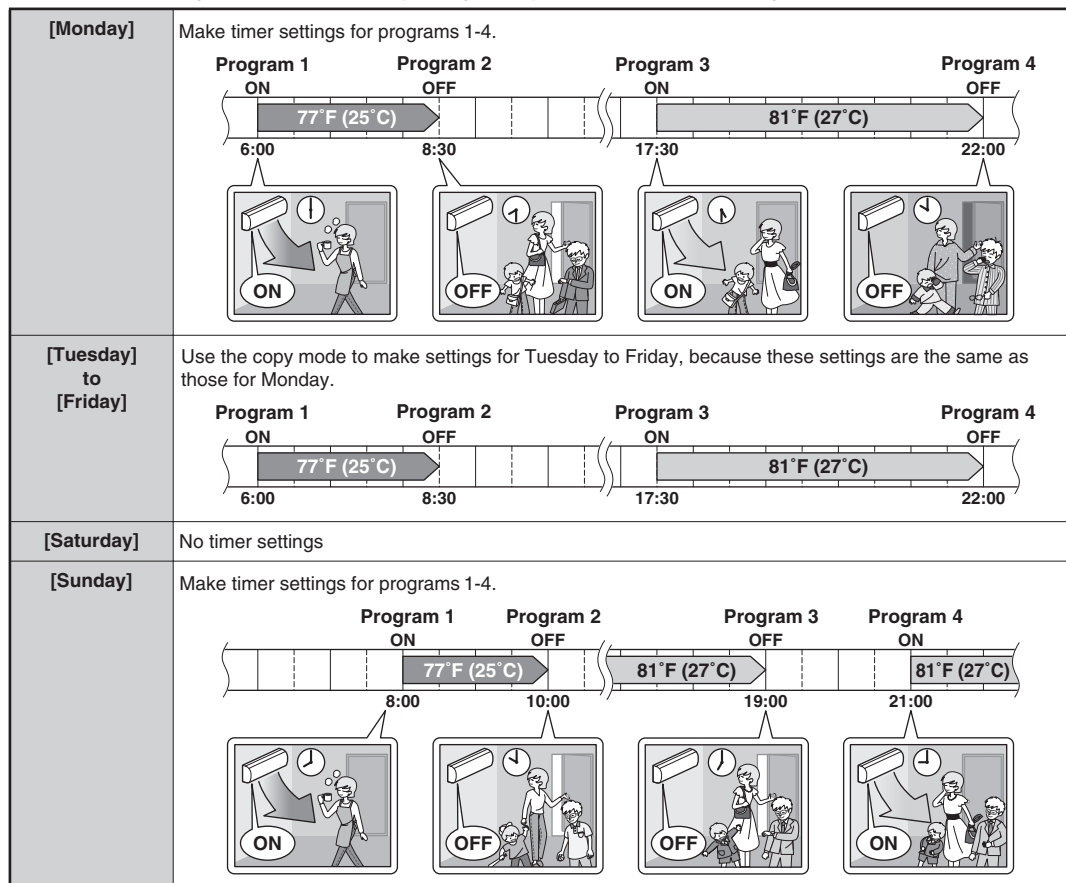

- Up to 4 reservations per day and 28 reservations per week can be set using the WEEKLY TIMER. The effective use of the copy mode simplifies timer programming.
- The use of ON-ON-ON-ON settings, for example, makes it possible to schedule operating mode and set temperature changes. Furthermore, by using OFF-OFF-OFF-OFF settings, only the turn off time of each day can be set. This will turn off the air conditioner automatically if you forget to turn it off.

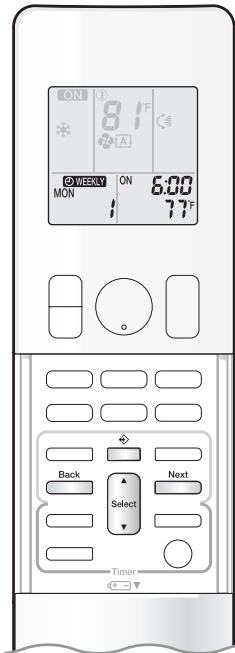

To use WEEKLY TIMER operation

Setting mode

- Make sure the day of the week and time are set.
If not, set the day of the week and time.

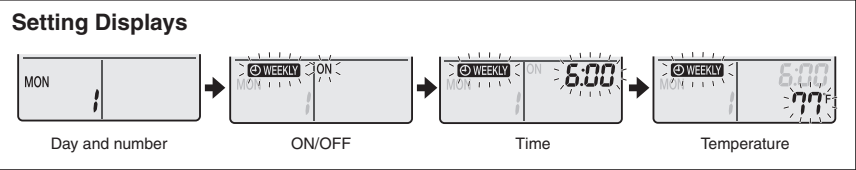
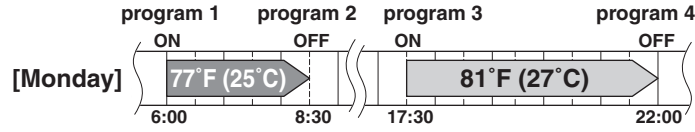

1. Press .

- The day of the week and the reservation number of the current day will be displayed.
- 1 to 4 settings can be made per day.

2. Press to select the desired day of the week and reservation number.

- Pressing changes the reservation number and the day of the week.

3. Press .

- The day of the week and reservation number will be set.
- “ WEEKLY ” and “ON” blink.

4. Press to select the desired mode.

- Pressing changes the “ON” or “OFF” setting in sequence.



- In case the reservation has already been set, selecting “ blank ” deletes the reservation.
- Proceed to **STEP 9** if “ blank ” is selected.
- To return to the day of the week and reservation number setting, press .

5. Press .

- The ON/OFF TIMER mode will be set.
- “ WEEKLY ” and the time blink.

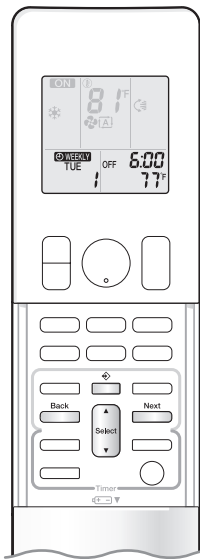

6. Press to select the desired time.

- The time can be set between 0:00 and 23:50 in 10-minute intervals.
- To return to the ON/OFF TIMER mode setting, press .
- Proceed to **STEP 9** when setting the OFF TIMER.

7. Press .

- The time will be set.
- “ WEEKLY” and the temperature blink.

8. Press to select the desired temperature.

- The temperature can be set between 50°F (10°C) and 90°F (32°C).
COOL or AUTO: The unit operates at 64°F (18°C) even if it is set at 50°F (10°C) to 63°F (17°C).
HEAT or AUTO : The unit operates at 86°F (30°C) even if it is set at 87°F (31°C) to 90°F (32°C).
- To return to the time setting, press .
- The set temperature is only displayed when the mode setting is on.

9. Press .

- Be sure to direct the remote controller toward the indoor unit and check for a receiving tone and blinking of the multi-monitor lamp.
- The multi-monitor lamp blinks twice.
- The temperature will be set and go to the next reservation.
- Temperature and time are set in the case of ON TIMER operation, and the time is set in the case of OFF TIMER operation.
- The next reservation screen will appear.
- To continue further settings, repeat the procedure from **STEP 4**.

10. Press to complete the setting.

- “ WEEKLY” is displayed on the LCD and WEEKLY TIMER operation is activated.
- The TIMER lamp periodically lights orange.
The multi-monitor lamp will not light orange if all the reservation settings are deleted.





Display

- A reservation made once can be easily copied and the same settings used for another day of the week. Refer to **Copy mode**.

NOTE

Notes on WEEKLY TIMER operation

- Do not forget to set the clock on the remote controller first.
- The day of the week, ON/OFF TIMER mode, time and set temperature (only for ON TIMER mode) can be set with the WEEKLY TIMER. Other settings for the ON TIMER are based on the settings just before the operation.
- WEEKLY TIMER and ON/OFF TIMER operation cannot be used at the same time. The ON/OFF TIMER operation has priority if it is set while WEEKLY TIMER is still active. The WEEKLY TIMER will enter the standby state, and “ WEEKLY” will disappear from the LCD. When the ON/OFF TIMER is up, the WEEKLY TIMER will automatically become active.
- Only the time and temperature can be set with the WEEKLY TIMER. Set the WEEKLY TIMER only after setting the operation mode, the airflow rate and the airflow direction ahead of time.
- Turning off the circuit breaker, power failure, and other similar events will render operation of the indoor unit's internal clock inaccurate. Reset the clock.
-  can be used only for the time and temperature settings. It cannot be used to go back to the reservation number.

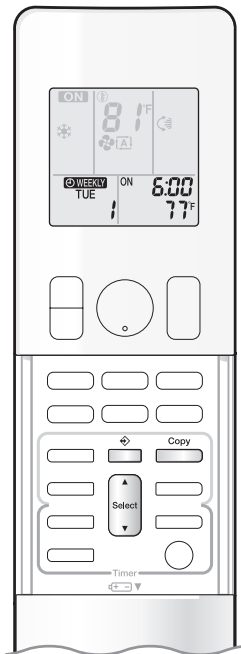

Copy mode

- A reservation made once can be copied to another day of the week. The whole reservation of the selected day of the week will be copied.

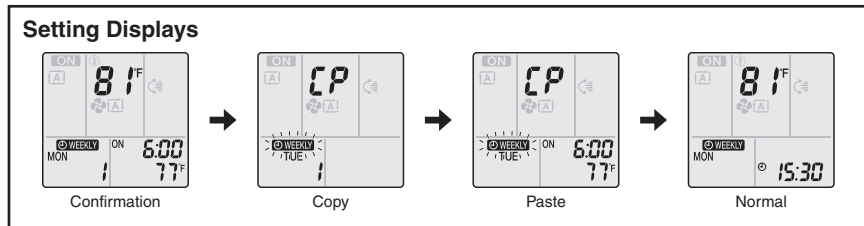
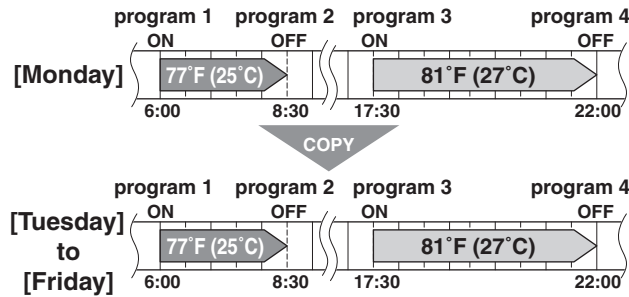

1. Press .
2. Press to confirm the day of the week to be copied.
3. Press .
 - The whole reservation of the selected day of the week will be copied.
4. Press to select the destination day of the week.
5. Press .
 - Be sure to direct the remote controller toward the indoor unit and check for a receiving tone and blinking of the multi-monitor lamp.
 - The multi-monitor lamp blinks twice.
 - The reservation will be copied to the selected day of the week. The whole reservation of the selected day of the week will be copied.
 - To continue copying the settings to other days of the week, repeat **STEP 4** and **STEP 5**.
6. Press to complete the setting.
 - “**WEEKLY**” is displayed on the LCD and WEEKLY TIMER operation is activated.
 - The TIMER lamp periodically lights orange.

NOTE

Note on COPY MODE

- The entire reservation of the source day of the week is copied in the copy mode.
- In the case of making a reservation change for any day of the week individually after copying the content of weekly reservations, press and change the settings in the steps of **Setting mode**.

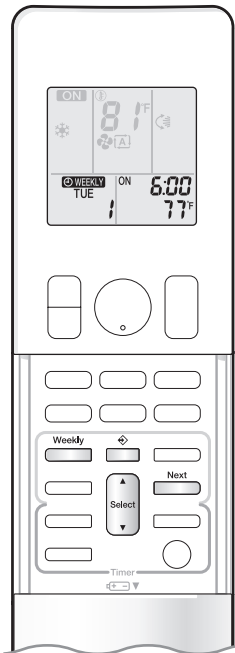

Confirming a reservation

- The reservation can be confirmed.

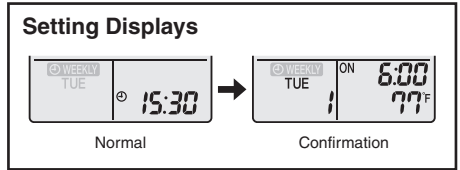

1. Press [Weekly].

- The day of the week and the reservation number of the current day will be displayed.

2. Press [Select] to select the day of the week and the reservation number to be confirmed.

- Pressing [Select] displays the reservation details.
- To change the confirmed reserved settings, select the reservation number and press [Next]. The mode is switched to setting mode. Proceed to **Setting mode STEP 4.**

3. Press [Weekly] to exit the confirmation mode.

- “ [WEEKLY] ” is displayed on the LCD and WEEKLY TIMER operation is activated.
- The TIMER lamp periodically lights orange.
The multi-monitor lamp will not light orange if all the reservation settings are deleted.



Display

To deactivate WEEKLY TIMER operation

Press [Weekly] while “ [WEEKLY] ” is displayed on the LCD.

- “ [WEEKLY] ” disappears from the LCD.
- The TIMER lamp goes off.
- To reactivate the WEEKLY TIMER operation, press [Weekly] again.
- If a reservation deactivated with [Weekly] is activated once again, the last reservation mode will be used.

NOTE

- If not all the reservation settings are reflected, deactivate the WEEKLY TIMER operation once. Then press [Weekly] again to reactivate the WEEKLY TIMER operation.

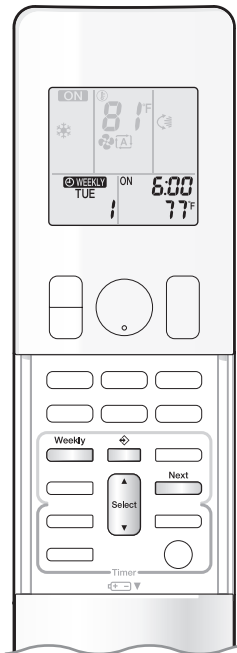

To delete reservations

An individual reservation

1. Press .

- The day of the week and the reservation number will be displayed.

2. Press **to select the day of the week and the reservation number to be deleted.**

3. Press .

- “ WEEKLY” and “ON” or “OFF” blink.

4. Press **until no icon is displayed.**

- Pressing changes the ON/OFF TIMER mode in sequence.
- Selecting “blank” will cancel any reservation you may have.



5. Press .

- The selected reservation will be deleted.
- Be sure to direct the remote controller toward the indoor unit and check for a receiving tone and blinking of the multi-monitor lamp.

6. Press .

- If there are still other reservations, WEEKLY TIMER operation will be activated.

Reservations for each day of the week

- This function can be used for deleting reservations for each day of the week.
- It can be used while confirming or setting reservations.

1. Press .

- The day of the week and the reservation number will be displayed.

2. Press **to select the day of the week to be deleted.**

3. Hold **for about 5 seconds.**

- Be sure to direct the remote controller toward the indoor unit and check for a receiving tone and blinking of the multi-monitor lamp.
- The reservation of the selected day of the week will be deleted.

4. Press .

- If there are still other reservations, WEEKLY TIMER operation will be activated.

All reservations

Hold **for about 5 seconds with the normal display.**

- Be sure to direct the remote controller toward the indoor unit and check for a receiving tone and blinking of the multi-monitor lamp.
- The TIMER lamp goes off.
- This operation cannot be used for the WEEKLY TIMER setting display.
- All reservations will be deleted.

2.14 Other Functions

2.14.1 Hot-Start Function

In order to prevent the cold air blast that normally occurs when heating operation starts, the temperature of the indoor heat exchanger is detected, and the airflow is either stopped or significantly weakened resulting in comfortable heating.



Note: The cold air blast is prevented using similar control when defrost control starts or when the thermostat is turned ON.

2.14.2 Signal Receiving Sign

When the indoor unit receives a signal from the remote controller, the unit emits a signal receiving sound and the operation lamp blinks.

2.14.3 Indoor Unit ON/OFF Button

ON/OFF button is provided on the display of the unit.

- Press **ON/OFF** button once to start operation. Press once again to stop it.
- **ON/OFF** button is useful when the remote controller is missing or the battery has run out.

Operation mode	Temperature setting	Airflow rate
AUTO	25°C (77°F)	Automatic

- In the case of multi system operation, there are times when the unit does not activate with this button.

CTXG Series

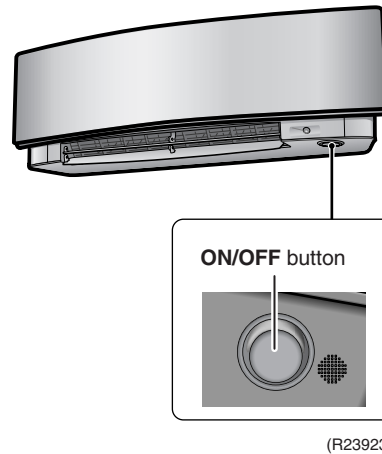

CTXS/FTXS Series

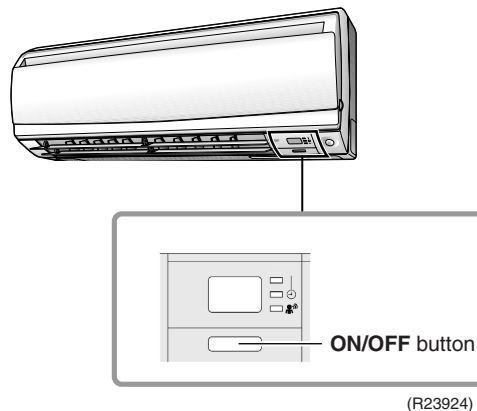

CDXS/FDXS Series

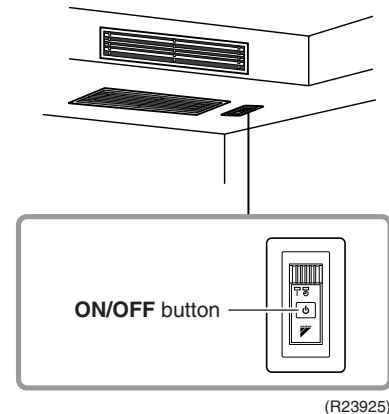

FVXS Series

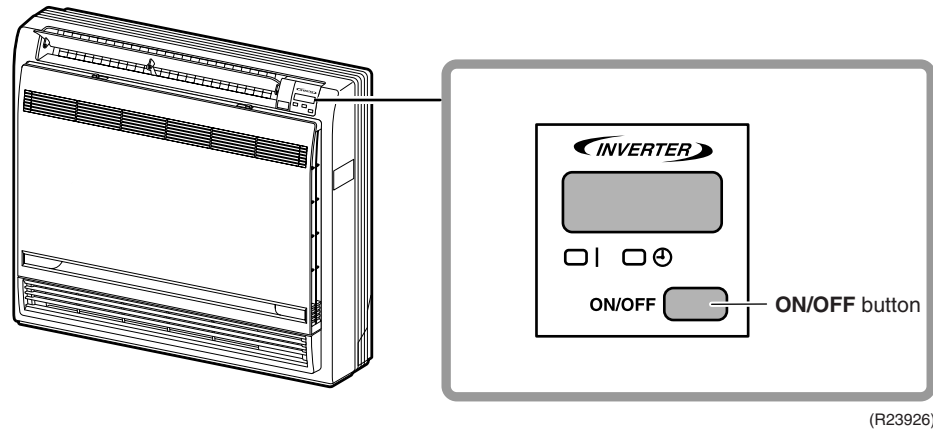

2.14.4 Auto-restart Function

If a power failure (even a momentary one) occurs during the operation, the system restarts automatically in the same conditions as before when the power supply is restored to the conditions prior to the power failure.



Note: It takes 3 minutes to restart the operation because the 3-minute standby function is activated.

3. FFQ Series Functions

3.1 Airflow Direction Control

Outline

There are two types of airflow direction settings.

- Automatic swing setting

The flaps automatically oscillate up and down.

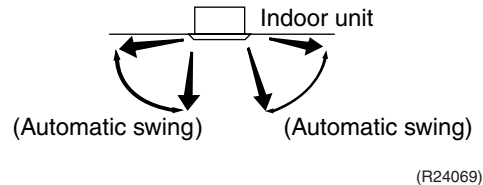

- Airflow direction fixed setting

You can select from one of the fixed directions.

The display of the remote controller and the actual angle of the flap do not match.

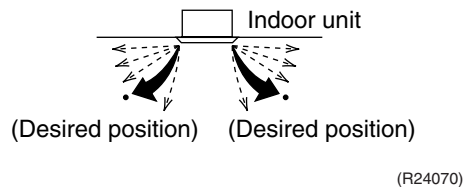

Flaps Movement

Under the operating conditions shown below, airflow direction is controlled automatically. Actual operation may be different from what is displayed on the remote controller.

- Room temperature is higher than the remote controller's set temperature in heating operation.
- When defrosting in heating operation. The airflow discharges horizontally to avoid blowing cold air directly on the room occupants.
- Under continuous operation with the airflow discharging horizontally.

Individual Flap Control

With decoration panels BYFQ60C2W1W(S) and wired remote controller (BRC1E73), you can control each one of the four flaps individually. The following marks are beside each air outlet: □, □□, □□□, □□□□.

3.2 Fan Speed Control for Indoor Unit

- With Wired Remote Controller (BRC1E73)

To change the fan speed, press **Fan Speed** button and select the fan speed from Low/Medium/High/Auto for three-speed.

- ◆ The system may change the fan speed automatically for equipment protection purposes.
- ◆ The system may turn off the fan when the room temperature is satisfied.
- ◆ It is normal for a delay to occur when changing the fan speed.
- ◆ If the Auto is selected for the fan speed, the fan speed varies automatically based on the difference between set temperature and room temperature.

- With Wireless Remote Controller Kit (BRC082A41W, BRC082A42W(S))

Press **FAN** button to select the fan speed, LOW, MEDIUM or HIGH.

3.3 Program Dry Operation

Outline Program dry operation removes humidity while preventing the room temperature from lowering. Since the microcomputer controls both the temperature and airflow rate, the temperature adjustment and **FAN** setting buttons are inoperable.

Details The microcomputer automatically sets the temperature and airflow rate. The difference between the room thermistor temperature at start-up and the target temperature is divided into two zones. Then, the unit operates in an appropriate capacity for each zone to maintain the temperature and humidity at a comfortable level.

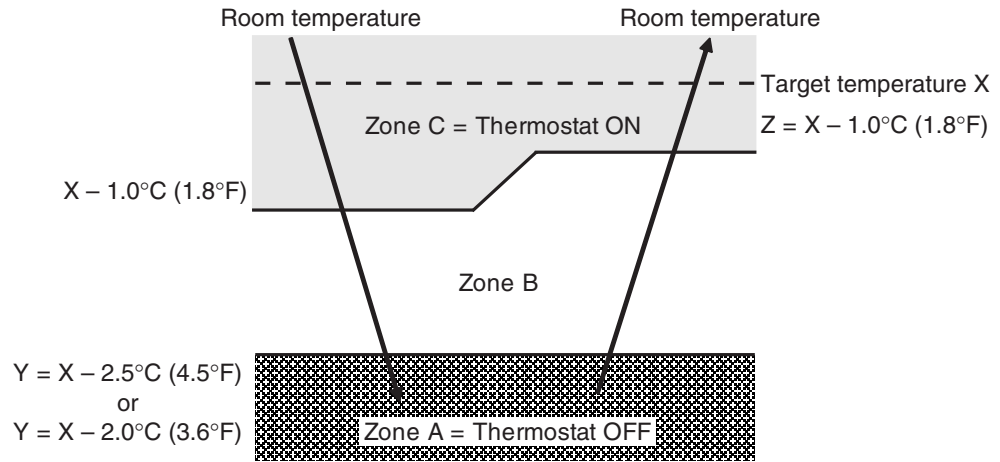

(R24367)

Room thermistor temperature at start-up	Target temperature X	Thermostat OFF point Y	Thermostat ON point Z
24.5°C or more (76.1°F or more)	Room thermistor temperature at start-up	X - 2.5°C (X - 4.5°F)	X - 1.0°C (X - 1.8°F)
16.5 ~ 24°C (61.7 ~ 75.2°F)		X - 2.0°C (X - 3.6°F)	X - 1.0°C (X - 1.8°F)
16°C or less (60.8°F or less)	16°C (60.8°F)	X - 2.0°C (X - 3.6°F)	X - 1.0°C = 15°C (X - 1.8°F = 59°F)

3.4 Clock and Calendar Setting (With Wired Remote Controller BRC1E73)

1

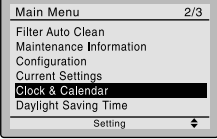

- Press **Menu/OK** button to display the main menu screen.
- Press **▼▲** buttons to select **Clock & Calendar** on the main menu screen.

Press **Menu/OK** button to display the clock & calendar screen.

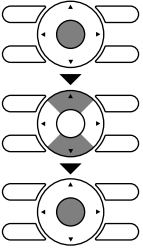

2

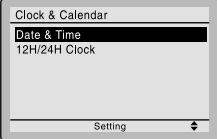

- Press **▼▲** buttons to select **Date & Time** on the clock & calendar screen.

Press **Menu/OK** button to display the date & time screen.

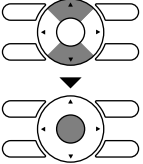

3

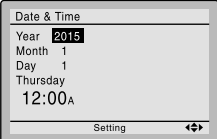

- Select **Year** with **◀▶** buttons.

Change the year with **▼▲** buttons. Holding down the button causes the number to change continuously.

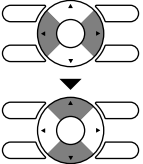

4

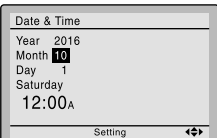

- Select **Month** with **◀▶** buttons.

Change the month with **▼▲** buttons. Holding down the button causes the number to change continuously.

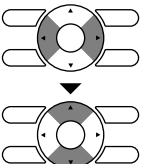

5

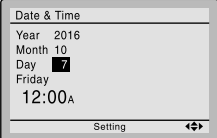

- Select **Day** with **◀▶** buttons.

Change the day with **▼▲** buttons. Holding down the button causes the number to change continuously. Days of the week change automatically.

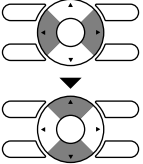

(R24368)

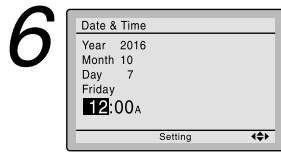

- Select **Hour** with ◀▶ buttons.
Change the hour with ▼▲ buttons.
Holding down the button causes the number to change continuously.

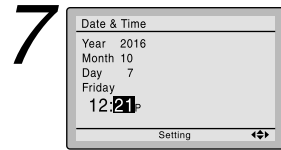
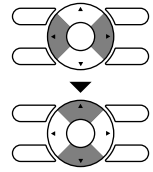

- Select **Minute** with ◀▶ buttons.
Change the minute with ▼▲ buttons.
Holding down the button causes the number to change continuously.
- Press **Menu/OK** button.
The confirmation screen will appear.

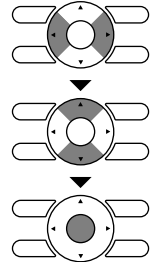

Note: _____
The date can be set between January 1, 2015 and December 31, 2099.

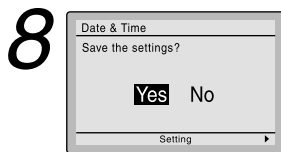

- Press ◀▶ button to select **Yes** on the confirmation screen.
Press **Menu/OK** button to confirm the clock and return to the basic screen.

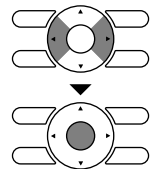

* When setting the schedule, the display returns to the settings screen.

(R24072)

3.5 Schedule TIMER Operation (With Wired Remote Controller BRC1E73)

Outline

Day settings are selected from 4 patterns:

- ◆ 7Days
- ◆ Weekday/Sat/Sun
- ◆ Weekday/Weekend
- ◆ Everyday

Up to 5 actions can be set for each day.

Details

Set the startup time and operation stop time.

ON: Startup time, cooling and heating temperature setpoints can be configured.

OFF: Operation stop time, cooling and heating setback temperature setpoints can be configured.

(--: Indicates that the setback function is disabled for this time period.)

___: Indicates that the temperature setpoint and setback temperature setpoint for this time period is not specified. The last active setpoint will be utilized.



Refer to Setback function on page 73 for details of setback function.

■ Setting the schedule

1

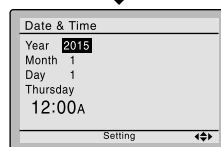
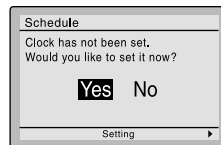
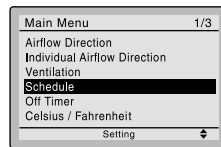

- Press **Menu/OK** button to display the main menu screen.
- Press **▼▲** buttons to select **Schedule**. Press **Menu/OK** button to display the schedule screen.
- Before setting the schedule, the clock must be set.
- If the clock has not been set, a screen like the one on the left will appear. Press **◀▶** buttons to select **Yes** and press **Menu/OK** button.
- The date & time screen will appear.
- Set the current year, month, day, and time.

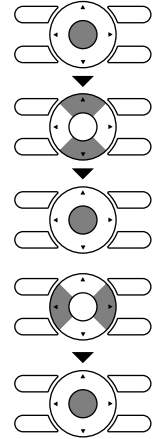

2

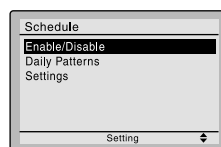

- Press **▼▲** buttons to select the desired function on the schedule screen and press **Menu/OK** button.

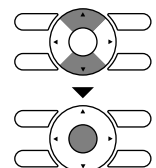

(R24369)

■ Daily Patterns

1

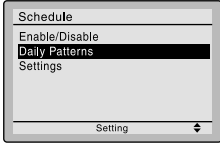

- The schedule screen will appear.
- Press ▼▲ buttons to select **Daily Patterns** on the schedule screen. The daily patterns screen will appear when **Menu/OK** button is pressed.

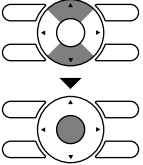

2

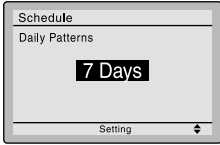

- Press ▼▲ buttons to select **7 Days**, **Weekday/Sat/Sun**, **Weekday/Weekend** or **Everyday** on the daily patterns screen. The confirmation screen will appear when **Menu/OK** button is pressed.

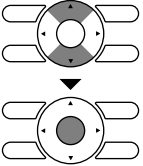

3

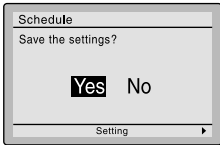

- Press ◀▶ buttons to select **Yes** on the confirmation screen. Pressing **Menu/OK** button enters the daily patterns in the schedule and takes you back to the main menu screen.

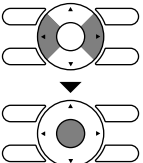

(R24074)

■ Settings

1

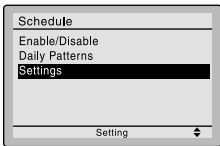

- The schedule screen will appear.
- Press ▼▲ buttons to select **Settings** on the schedule screen. The settings screen will appear when **Menu/OK** button is pressed.

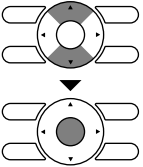

2

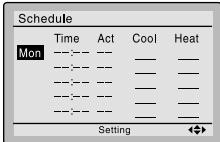

- Press ▼▲ buttons to select the day to be set.
- * It cannot be selected in the case of **EVDY**.

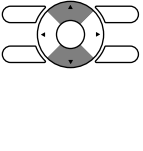

3

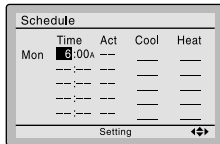
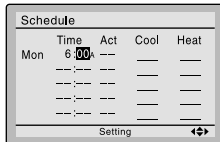

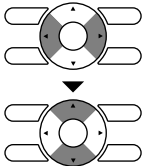

- Input the time for the selected day.
- Press ◀▶ buttons to move the highlighted item and press ▼▲ buttons to input the desired operation start time. Each press of ▼▲ buttons moves the numbers by 1 hour or 1 minute.

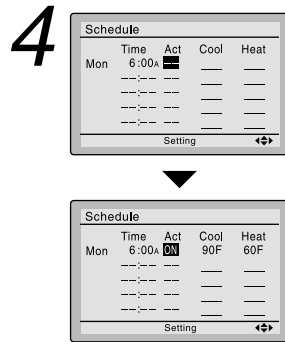

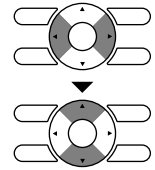

- Press ◀▶ buttons to move the highlighted item and press ▼▲ buttons to configure ON/OFF/-- settings. --, ON, or OFF changes in sequence when ▼▲ buttons are pressed.



- ON: The temperature setpoints can be configured.
- OFF: The setback temperature setpoints can be configured.
- : The temperature setpoints and setback temperature setpoints become disabled.

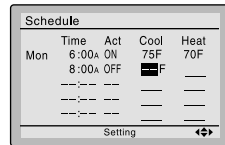

- The cooling and heating temperature setpoints for both ON and OFF (Setback) are configured.

- _: Indicates that the temperature setpoint and setback temperature setpoint for this time period is not specified. The last active setpoint will be utilized.
- : Indicates that the setback function is disabled for this time period.

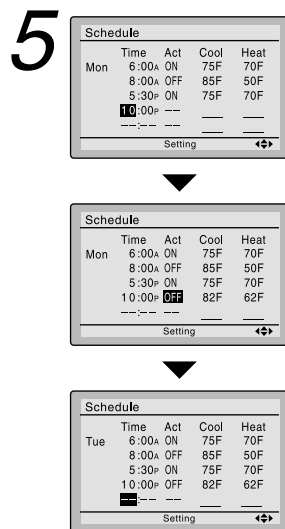

- A maximum of five actions per day can be set.

- Press **Menu/OK** button when settings for each day are completed. The confirmation screen will appear.

- To copy the settings for the previous day, press **Mode** button so that the existing settings will be copied. Example: The contents for Monday are copied by pressing **Mode** button after selecting Tuesday.

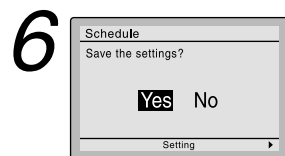
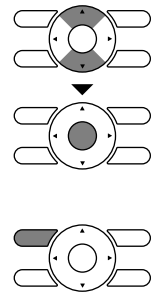

- Press ◀▶ buttons to select **Yes** on the confirmation screen. Pressing **Menu/OK** button confirms the settings for each day and takes you back to the basic screen.

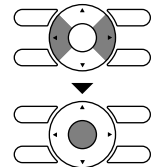

(R24075)

■ Enabling or disabling the schedule

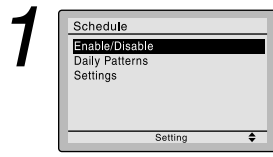

- Display the schedule screen.
- Press ▼▲ buttons to select **Enable / Disable** on the schedule screen. Press **Menu/OK** button to display the enable/disable screen.

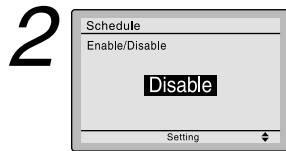
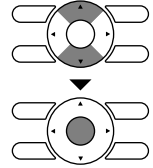

- Press ▼▲ buttons to select **Enable** or **Disable** on the enable/disable screen. Press **Menu/OK** button after selecting the item. The confirmation screen is displayed.

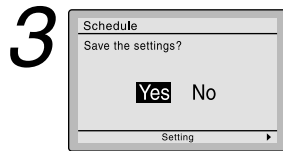
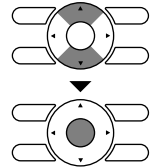

- Press ◀▶ buttons to select **Yes** on the confirmation screen. Pressing **Menu/OK** button confirms the enable/disable setting for the schedule and takes you back to the basic screen.

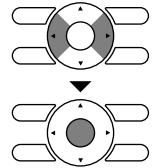

(R24076)

3.6 Setback Function (With Wired Remote Controller BRC1E73)

The Setback function can be used to maintain the space temperature in an assigned range for an unoccupied period.

The setback icon flashes on the LCD of wired remote controller when the unit is turned on by the setback control.

- When enabled, the Setback mode becomes active when the indoor unit is turned off by either the user, a schedule event or an off timer.
- Setback function is not available by default. It can be enabled by the system installer.

3.7 Drain Pump Control

3.7.1 Normal Operation

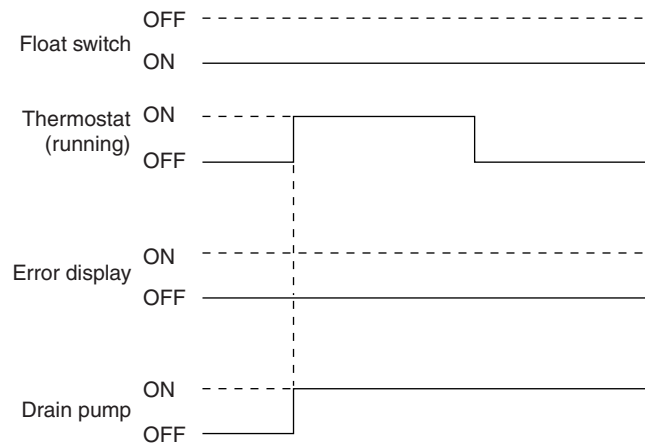

(R24037)

- ◆ The float switch is ON in normal operation.
- ◆ When cooling operation starts (thermostat ON), the drain pump turns ON simultaneously.
- ◆ After the thermostat turns OFF, the drain pump continues to operate.

3.7.2 If the Float Switch is OFF with the Thermostat ON in Cooling Operation

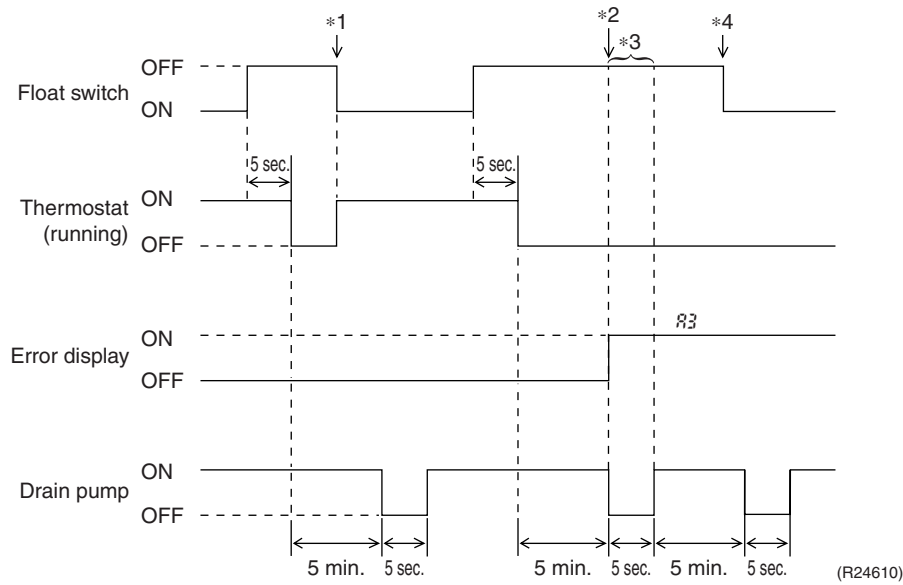

- ◆ When the float switch stays OFF for 5 sec., the thermostat turns OFF.
- ◆ After the thermostat turns OFF, the drain pump continues to operate for another 5 minutes.
- *1: If the float switch turns ON again during the residual operation of the drain pump, cooling operation also turns on again (thermostat ON).
- *2: If the float switch remains OFF even after the residual operation of the drain pump has ended, the error code R3 is determined.
- *3: The drain pump turns OFF once residual operation has ended, then turns ON again after 5 seconds.
- *4: After R3 is determined and the unit comes to an abnormal stop, the thermostat will remain OFF even if the float switch turns ON again.

3.7.3 If the Float Switch is OFF with the Thermostat OFF in Cooling Operation

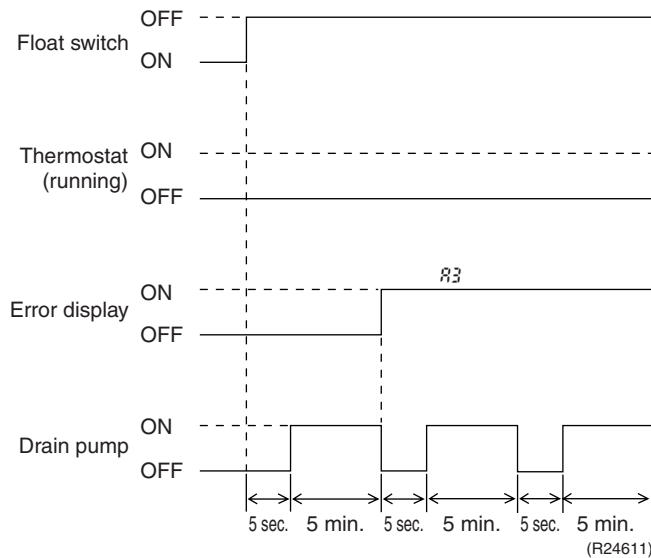

- ◆ When the float switch stays OFF for 5 sec., the drain pump turns ON.
- ◆ If the float switch remains OFF even after the residual operation of the drain pump has ended, the error code R3 is determined.
- ◆ The drain pump turns OFF once residual operation has ended, then turns ON again after 5 seconds.

3.7.4 If the Float Switch Turns OFF and ON Continuously, or the Float Switch Turns OFF While R_F Displayed

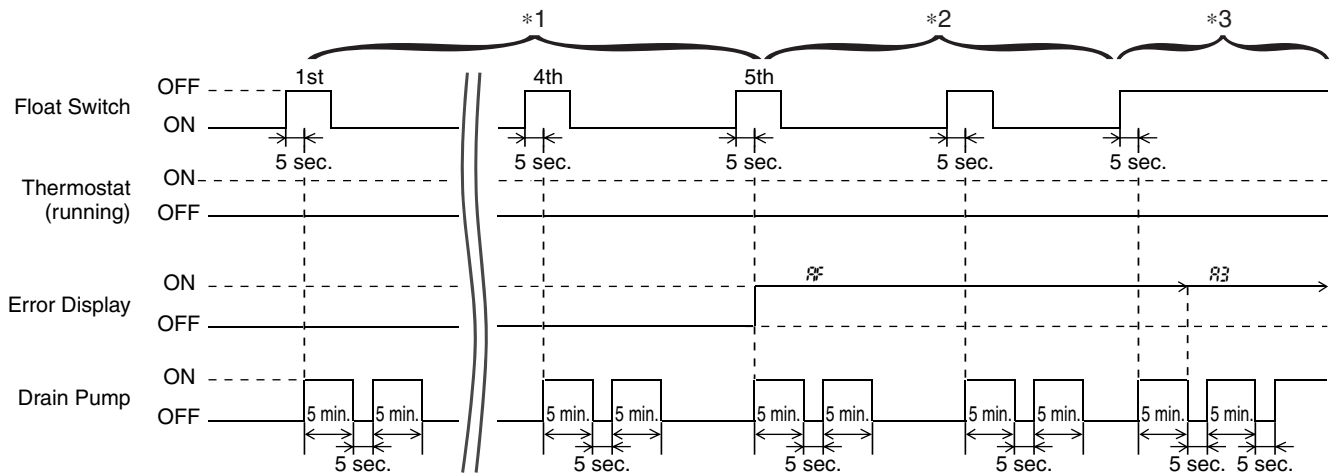

(R24370)

- ◆ When the float switch stays OFF for 5 sec., the drain pump turns ON.
- *1: If the float switch continues to turn OFF and ON 5 times consecutively, it is judged as a drain system error and the error code R_F is determined.
- *2: The drain pump continues to turn ON/OFF in accordance with the float switch OFF/ON even after R_F is determined.
- *3: While the error code R_F is active, if the float switch remains OFF even after the residual operation of the drain pump has ended, the error code R₃ will be determined.

3.8 Hot Start Control (In Heating Operation Only)

Outline

At startup with thermostat ON or after the completion of defrosting in heating operation, the indoor unit fan is controlled to prevent cold air from blasting out and ensure startup capacity.

Details

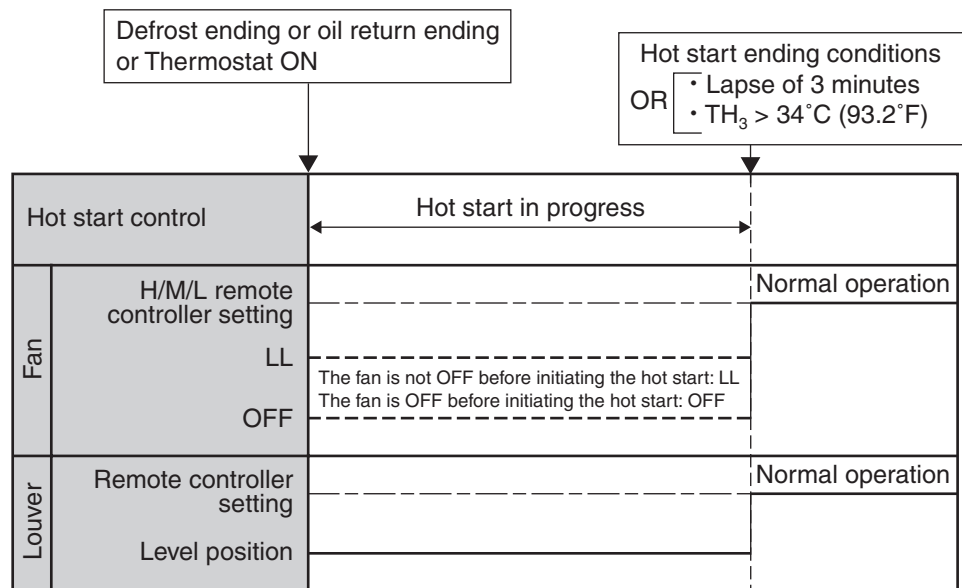

(R24041)

TH₃: Temperature detected by the indoor heat exchanger thermistor (R3T)

3.9 Presence and Floor Sensors (Option)

Outline

With the human presence signal and the floor temperature signal from the optional sensor kit, the system provides the energy saving control, or the comfortable temperature control and airflow direction control preventing the direct draft to the human.

To use sensor related functions, a wired remote controller (BRC1E73) and optional sensor kit (BRYQ60A2W(S)) are necessary to be installed.

Details

1. Draft prevention (with presence sensor)

When the sensor detects human presence during auto-swing operation, the system sets the airflow direction parallel to the floor (position 0) to reduce unpleasant draft.

The operation returns to the normal auto-swing as the sensor detects no human in the room.

- Draft prevention is enabled only when decoration panel BYFQ60C2W1W(S), sensor kit BRYQ60A2W(S) and wired remote controller BRC1E73 are connected to the main unit and draft prevention is set to “enabled” on the wired remote controller.
- Factory setting is “disabled”.
- Draft prevention cannot be activated when individual flap control is set, even if draft prevention is enabled on the wired remote controller.

Setting on the wired remote controller

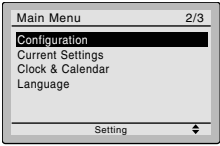
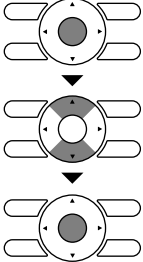
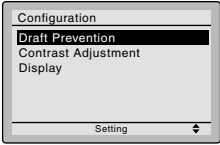
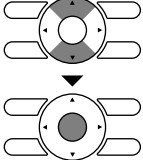
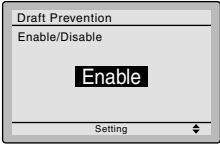
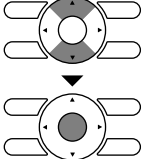
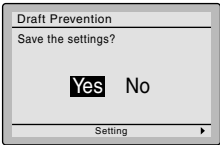
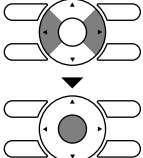
1		<ul style="list-style-type: none"> ● Press Menu/OK button to display the main menu screen. ● Press ▼▲ buttons to select Configuration and press Menu/OK button. 	
2		<ul style="list-style-type: none"> ● Press ▼▲ buttons to select Draft Prevention and press Menu/OK button. 	
3		<ul style="list-style-type: none"> ● Press ▼▲ buttons to select Enable. ● The confirmation screen will appear when Menu/OK button is pressed. 	
4		<ul style="list-style-type: none"> ● Press ◀▶ buttons to select Yes. ● Press Menu/OK button to confirm the settings and to return to the basic screen. 	

2. Auto-setback by sensor (with presence sensor)

After pre-determined time has elapsed without detection of human presence, the unit automatically shifts the target temperature gradually for energy saving.

The target temperature displayed on the remote controller remains same as the initial set value during the above change of target temperature.

The target temperature shifts within the range of the highest programmable temperature while in cooling operation and the lowest programmable temperature while in heating operation.

Upon human detection, the target temperature returns to the original setting.

- Auto-setback by sensor is enabled only when decoration panel BYFQ60C2W1W(S), sensor kit BRYQ60A2W(S) and wired remote controller BRC1E73 are connected to the main unit and auto-setback by sensor is set to “enabled” on the wired remote controller.
- Factory setting is “disabled”.

Setting on the remote controller

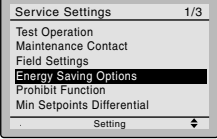
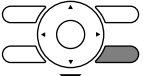
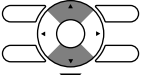
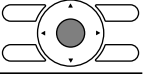
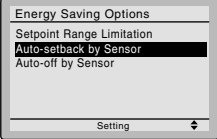
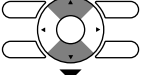
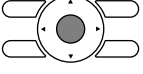
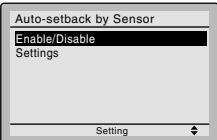
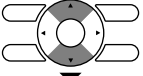
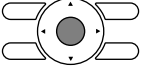
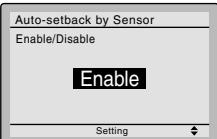
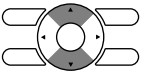
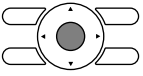
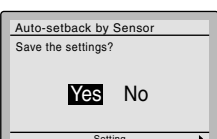
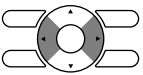
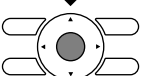
1		<ul style="list-style-type: none"> • Press Cancel button for 4 seconds on the basic screen to display Service Settings menu. • Press ▼▲ buttons to select Energy Saving Options. • Press Menu/OK button to display Energy Saving Options menu. 	  
2		<ul style="list-style-type: none"> • Press ▼▲ buttons to select Auto-setback by Sensor. • Press Menu/OK button to display Auto-setback by Sensor menu. 	 
3		<ul style="list-style-type: none"> • Press ▼▲ buttons to select Enable/Disable. • Press Menu/OK button. 	 
4		<ul style="list-style-type: none"> • Press ▼▲ buttons to select Enable. • Press Menu/OK button after selecting the item. Then the confirmation screen is displayed. 	 
5		<ul style="list-style-type: none"> • Press ◀▶ buttons to select Yes. • Press Menu/OK button to confirm the settings and to return to the Service Settings menu. 	 

3. Auto-off by sensor (with presence sensor)











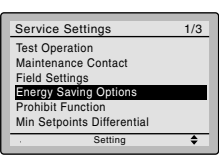

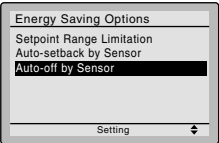

After pre-determined time has elapsed without detection of human presence, the unit automatically stops operation.

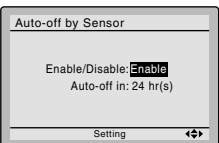
The auto-off time can be set between 1- 24 hours by the hour.

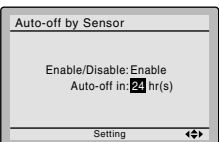
Once the unit stops operation by auto-off function, the system would not restart even if the human is detected again.

- Auto-off by sensor is enabled only when decoration panel BYFQ60C2W1W(S), sensor kit BRYQ60A2W(S) and wired remote controller BRC1E73 are connected to the main unit and auto-off by sensor is set to “enabled” on the wired remote controller.
- Factory setting is “disabled”.

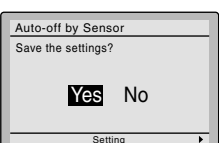
Setting on the remote controller

1		<ul style="list-style-type: none"> • Press Cancel button for 4 seconds on the basic screen to display Service Settings menu. • Press ▼▲ buttons to select Energy Saving Options. • Press Menu/OK button to display Energy Saving Options menu. 	  
2		<ul style="list-style-type: none"> • Press ▼▲ buttons to select Auto-off by Sensor. • Press Menu/OK button to display Auto-off by Sensor menu. 	 
3		<ul style="list-style-type: none"> • Press ▼▲ buttons to select Enable. 	
4		<ul style="list-style-type: none"> • Press ◀▶ buttons to go into the auto-off time setting. • Press ▼▲ buttons to set auto-off hour(s) (1 ~ 24). • Press Menu/OK button. Then the confirmation screen is displayed. 	  
5		<ul style="list-style-type: none"> • Press ◀▶ buttons to select Yes. • Press Menu/OK button to confirm the settings and to return to the Service Settings menu. 	 

4. Room temperature adjustment by sensing (with floor sensor)

The system uses living space temperature calculated from temperatures detected by room temperature thermistor (suction air thermistor in the indoor unit) and floor sensor, as the target temperature.

Operation becomes more optimized by using not only suction air temperature but floor temperature.

- This function is enabled when decoration panel BYFQ60C2WAW(S) and sensor kit BRYQ60A2W(S) is connected to the main unit.

3.10 Other Functions

3.10.1 Signal Receiving Sign

When the indoor unit receives a signal from the remote controller, the unit emits a signal receiving sound.

3.10.2 Auto-restart Function

If a power failure (even a momentary one) occurs during the operation, the system restarts automatically in the same conditions as before when the power supply is restored to the conditions prior to the power failure.



Note: It takes 3 minutes to restart the operation because the 3-minute standby function is activated.

3.10.3 Emergency Operation Switch (With Wireless Remote Controller Kit BRC082A41W, BRC082A42W(S))

When the remote controller does not work due to battery failure or the absence thereof, use the emergency operation switch.

Start

Press emergency operation switch.

- ◆ The unit runs in the previous mode.
- ◆ The system operates with the previously set airflow direction.

Stop

Press emergency operation switch again.

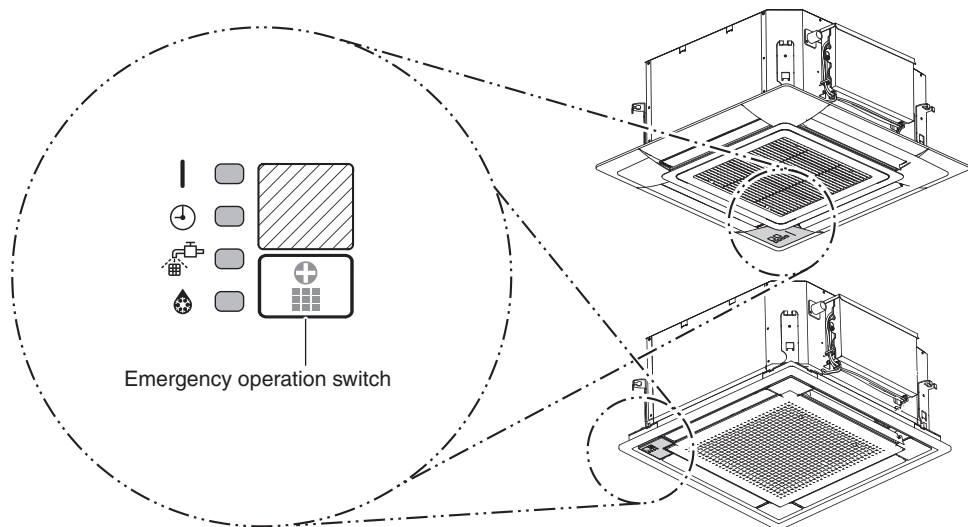

(R24077)

4. Control Specification

4.1 Thermistor Functions

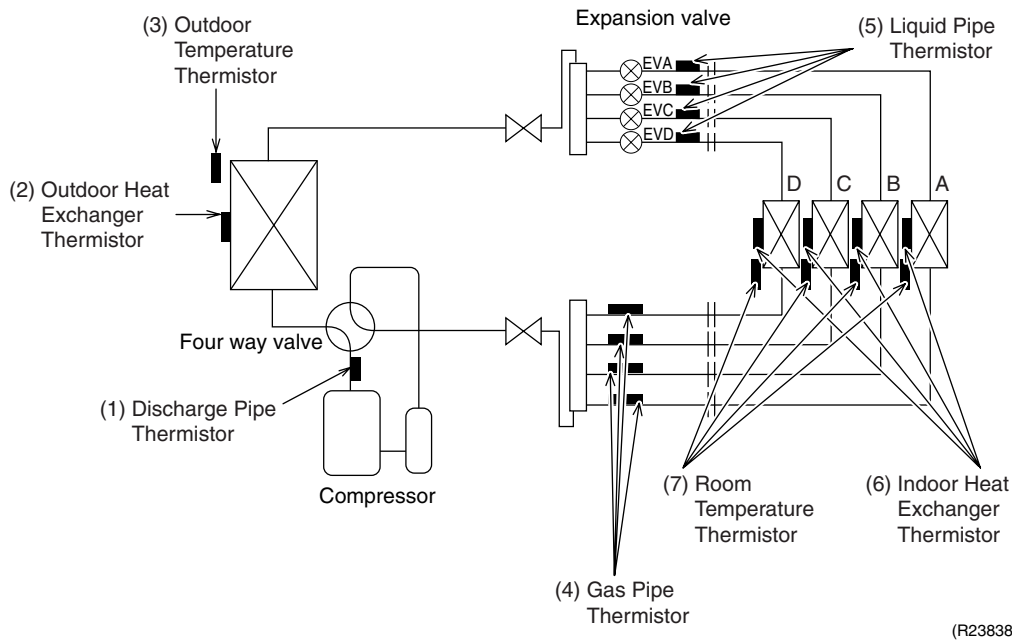

- ★ The illustration is for the 4-room models as representative and have 4 lines of indoor unit system (A – D). The 3-room models have 3 lines (A – C) and 2-room models have 2 lines (A – B).

(1) Discharge Pipe Thermistor

- The discharge pipe thermistor is used for controlling discharge pipe temperature. If the discharge pipe temperature (used in place of the inner temperature of the compressor) rises abnormally, the operating frequency becomes lower or the operation halts.
- The discharge pipe thermistor is used for detecting disconnection of the discharge pipe thermistor.

(2) Outdoor Heat Exchanger Thermistor

- The outdoor heat exchanger thermistor is used for controlling the target discharge pipe temperature. The system sets the target discharge pipe temperature according to the outdoor and indoor heat exchanger temperature, and controls the electronic expansion valve opening so that the target discharge pipe temperature can be obtained.
- In cooling operation, the outdoor heat exchanger thermistor is used for detecting the disconnection of the discharge pipe thermistor. When the discharge pipe temperature drops below the outdoor heat exchanger temperature by more than a certain value, the discharge pipe thermistor is judged as disconnected.
- In cooling operation, the outdoor heat exchanger thermistor is used for high pressure protection.

(3) Outdoor Temperature Thermistor

- The outdoor temperature thermistor detects the outdoor air temperature and is used for refrigerant shortage detection, input current control, outdoor fan control, liquid compression protection function, and so on.

(4) Gas Pipe Thermistor

- In cooling operation, the gas pipe thermistor is used for gas pipe isothermal control. The system controls electronic expansion valve opening so that the gas pipe temperature in each room becomes equal.

(5) Liquid Pipe Thermistor

- Liquid pipe thermistor is used to protect the compressor against liquid attack during cooling operation.
- In case of low outdoor temperature operation, the system compares the indoor heat exchanger temperature with the liquid pipe temperature to detect disturbances in the refrigerant flow. If any, the system adjusts the opening of the electronic expansion valve to control the refrigerant flow.
- When only one indoor unit is in heating operation, the liquid pipe thermistor is used for subcooling control. The actual subcool is calculated with the liquid pipe temperature and the maximum indoor heat exchanger temperature. The system controls the electronic expansion valve openings to obtain the target subcool.
- In heating operation, the liquid pipe thermistor is used for liquid pipe isothermal control. The system controls the electronic expansion valve opening so that the liquid pipe temperatures in each room becomes equal.

(6) Indoor Heat Exchanger Thermistor

- The indoor heat exchanger thermistor is used for controlling the target discharge pipe temperature. The system sets the target discharge pipe temperature according to the outdoor and indoor heat exchanger temperature, and controls the electronic expansion valve opening so that the target discharge pipe temperature can be obtained.
- In cooling operation, the indoor heat exchanger thermistor is used for freeze-up protection control. If the indoor heat exchanger temperature drops abnormally, the operating frequency becomes lower or the operation halts.
- In cooling operation, the indoor heat exchanger thermistor is used for anti-icing function. If any of the following conditions are met in the room where operation halts, it is assumed as icing. The conditions are

$$T_c \leq -1^\circ \text{C}$$

$$T_a - T_c \geq 10^\circ \text{C}$$
 where T_a is the room temperature and T_c is the indoor heat exchanger temperature.
- The indoor heat exchanger thermistor is used for wiring error check function. The refrigerant flows in order from the port A to detect the indoor heat exchanger temperature one by one, and then wiring and piping can be checked.
- In heating operation, the indoor heat exchanger thermistor is used for heating peak-cut control. If the indoor heat exchanger temperature rises abnormally, the operating frequency becomes lower or the operation halts.
- In heating operation, the indoor heat exchanger thermistor is used for detecting the disconnection of the discharge pipe thermistor. When the discharge pipe temperature drops below the highest indoor heat exchanger temperature by more than a certain value, the discharge pipe thermistor is judged as disconnected.
- When only one indoor unit is operating, the indoor heat exchanger thermistor is used for subcooling control. The actual subcool is calculated with the liquid pipe temperature and the indoor heat exchanger temperature. The system controls the electronic expansion valve openings to obtain the target subcool.

(7) Room Temperature Thermistor

- The room temperature thermistor detects the room air temperature and is used for controlling the room air temperature.

4.2 Mode Hierarchy

Outline

Air conditioner control has normal operation mode, forced operation mode, and power transistor test mode for installation and servicing.

Details

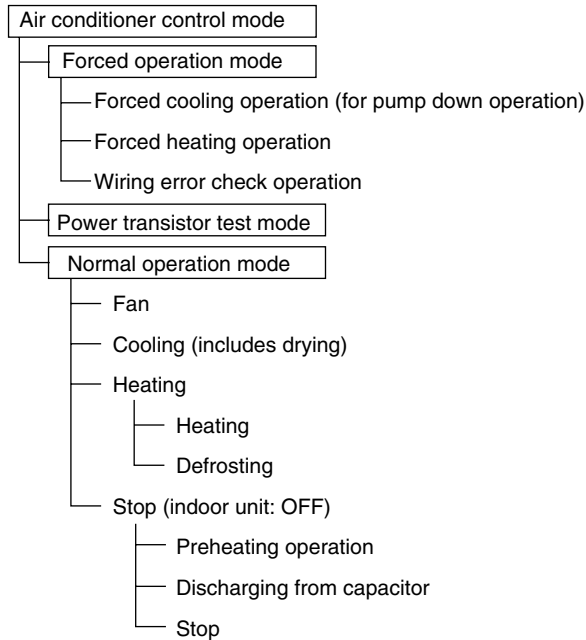

(R17361)



- Note:**
- Unless specified otherwise, dry operation command is regarded as cooling operation.
 - Indoor fan operation cannot be made in multiple indoor units. (A forced fan command is made during forced cooling operation.)

Determine Operation Mode

The system judges the operation mode command which is set by each room in accordance with the procedure, and determines the operation mode of the system.

The following procedure is taken when the modes conflict with each other.

*1. The system follows the mode which is set first. (First-push, first-set)

*2. For the rooms where the different mode is set, standby mode is activated. (The operation lamp blinks.)

4.3 Frequency Control

Outline

Frequency that corresponds to each room's capacity is determined according to the difference between the target temperature and the temperature of each room.

When the shift of the frequency is less than zero ($\Delta F < 0$) by PI control, the target frequency is used as the command frequency.

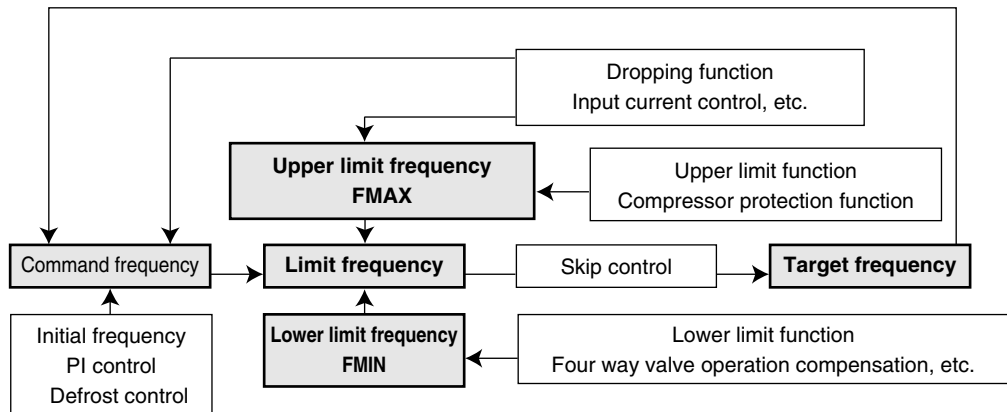

(R18023)

Details

The compressor's frequency is determined by taking the following steps.

1. Determine command frequency

Command frequency is determined in the following order of priority.

1. Limiting defrost control time
2. Forced cooling/heating
3. Indoor frequency command

2. Determine upper limit frequency

The minimum value is set as upper limit frequency among the frequency upper limits of the following functions:

Compressor protection, input current, discharge pipe temperature, low Hz high pressure limit, heating peak-cut, freeze-up protection, defrost.

3. Determine lower limit frequency

The maximum value is set as the lower limit frequency among the frequency lower limits of the following functions:

Four way valve operation compensation, draft prevention, pressure difference upkeep.

4. Determine prohibited frequency

There is a certain prohibited frequency such as a power supply frequency.

Parameters**Q value**

Indoor unit output determined from indoor unit volume, airflow rate and other factors.

S value: Indoor Unit Capacity

An S value is the capacity of the indoor unit, and is used for frequency command.

Ex:	Capacity	S value	Capacity	S value
	9 kBtu/h	25	18 kBtu/h	50
	12 kBtu/h	35	24 kBtu/h	60

 ΔD signal: Indoor frequency command

The difference between the room thermistor temperature and the target temperature is taken as the ΔD value and is used for the ΔD signal of frequency command.

Temperature difference	ΔD signal	Temperature difference	ΔD signal	Temperature difference	ΔD signal	Temperature difference	ΔD signal
-2.0°C (-3.6°F)	*OFF	0°C (0°F)	4	2.0°C (3.6°F)	8	4.0°C (7.2°F)	12
-1.5°C (-2.7°F)	1	0.5°C (0.9°F)	5	2.5°C (4.5°F)	9	4.5°C (8.1°F)	13
-1.0°C (-1.8°F)	2	1.0°C (1.8°F)	6	3.0°C (5.4°F)	10	5.0°C (9°F)	14
-0.5°C (-0.9°F)	3	1.5°C (2.7°F)	7	3.5°C (6.3°F)	11	5.5°C (9.9°F)	15

Values depend on the type of indoor unit.

*OFF = Thermostat OFF

Initial Frequency

When starting the compressor, or when conditions are varied due to a change of operating rooms, the frequency must be initialized according to a total of the maximum ΔD value of each room and a total Q value (ΣQ) of the operating room (the room in which the thermostat is set to ON).

PI Control**1. P control**

The $\Sigma \Delta D$ value is calculated in each sampling time (20 seconds), and the frequency is adjusted according to its difference from the frequency previously calculated.

2. I control

If the operating frequency does not change for more than a certain fixed time, the frequency is adjusted according to the $\Sigma \Delta D$ value.

When $\Sigma \Delta D$ value is low, the frequency is lowered.

When $\Sigma \Delta D$ value is high, the frequency is increased.

3. Limit of frequency increasing range

When the difference between the input current and the dropping value of the input current is less than 1.5 A, the frequency increasing range must be limited.

4. Frequency control when other controls are functioning

- ◆ When frequency is dropping:

Frequency control is carried out only when the frequency drops.

- ◆ For limiting lower limit:

Frequency control is carried out only when the frequency rises.

5. Upper and lower limit of frequency by PI control

The frequency upper and lower limits are set according to the total of S values. When the indoor unit quiet operation commands come from more than one room or when the outdoor unit quiet operation commands come from all the rooms, the upper limit frequency is lower than the usual setting.

4.4 Controls at Mode Changing/Start-up

4.4.1 Preheating Control

Outline The inverter operation in open phase starts with the conditions of the outdoor temperature and the preheating command from the indoor unit.

Details

ON Condition

- ◆ When the outdoor temperature is below 20°C (68°F), the inverter operation in open phase starts.

OFF Condition

- ◆ When the outdoor temperature is higher than 22°C (71.6°F), the inverter operation in open phase stops.

4.4.2 Four Way Valve Switching

Outline The four way valve coil is energized/not energized depending on the operation mode. (Heating: ON, Cooling/Dry/Defrost: OFF) In order to eliminate the switching sound as the four way valve coil switches from ON to OFF when the heating is stopped, the OFF delay switch of the four way valve is carried out.

Details

OFF delay switch of four way valve:

The four way valve coil is energized for 150 seconds after the operation is stopped.

4.4.3 Four Way Valve Operation Compensation

Outline At the beginning of the operation as the four way valve is switched, the pressure difference to activate the four way valve is acquired when the output frequency is higher than a certain fixed frequency, for a certain fixed time.

Details

Starting Conditions

- Compressor starts and the four way valve switches from OFF to ON
- Four way valve switches from ON to OFF during operation
- Compressor starts after resetting
- Compressor starts after the fault of four way valve switching

The lower limit of frequency keeps **A** Hz for 70 seconds for any of the conditions above.

A (Hz)	Cooling	Heating
18 class	74	62
24/36 class	42	35

4.4.4 3-Minute Standby

Turning on the compressor is prohibited for 3 minutes after turning off.
(The function is not used when defrosting.)

4.4.5 Compressor Protection Function

When turning the compressor from OFF to ON, the upper limit of frequency is set as follows.
(The function is not used when defrosting.)

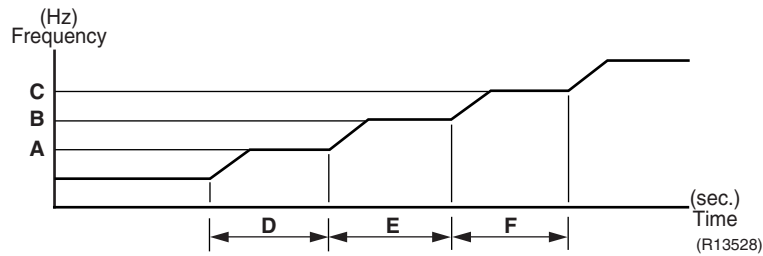

	18 class	24/36 class
A (Hz)	55	35 ~ 55
B (Hz)	65	48 ~ 65
C (Hz)	80	70 ~ 80
D (seconds)	180	120
E (seconds)	360	200 ~ 500
F (seconds)	400	180 ~ 470

4.5 Discharge Pipe Temperature Control

Outline

The discharge pipe temperature is used as the internal temperature of the compressor. If the discharge pipe temperature rises above a certain level, the upper limit of frequency is set to keep the discharge pipe temperature from rising further.

Details

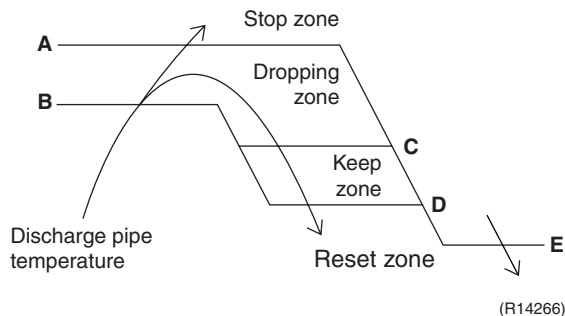

	18 class	24/36 class
A	120°C (248°F)	120°C (248°F)
B	103°C (217.4°F)	111°C (231.8°F)
C	102°C (215.6°F)	109°C (228.2°F)
D	100°C (212°F)	107°C (224.6°F)
E	95°C (203°F)	107°C (224.6°F)

Zone	Control
Stop zone	When the temperature reaches the stop zone, the compressor stops.
Dropping zone	The upper limit of frequency decreases.
Keep zone	The upper limit of frequency is kept.
Reset zone	The upper limit of frequency is canceled.

4.6 Input Current Control

Outline

The microcomputer calculates the input current while the compressor is running, and sets the frequency upper limit based on the input current.

In case of heat pump models, this control is the upper limit control of frequency and takes priority over the lower limit control of four way valve operation compensation.

Details

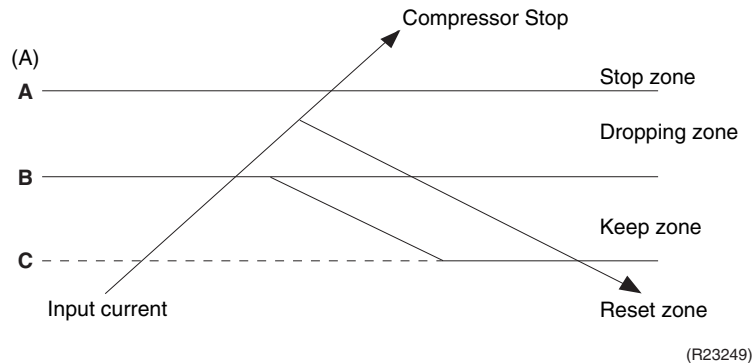

Frequency control in each zone

Stop zone

- After the input current remains in the stop zone for 2.5 seconds, the compressor is stopped.

Dropping zone

- The upper limit of the compressor frequency is defined as operation frequency – 2 Hz.
- After this, the output frequency is lowered by 2 Hz every second until it reaches the keep zone.

Keep zone

- The present maximum frequency goes on.

Reset zone

- Limit of the frequency is canceled.

	18 class		24 class		36 class	
	Cooling	Heating	Cooling	Heating	Cooling	Heating
A (A)	13.0	15.0	15.5	17.5	18.0	18.5
B (A)	11.5	14.0	14.0	15.5	17.0	17.5
C (A)	10.5	13.0	13.0	14.5	16.0	16.5

Limitation of current dropping and stop value according to the outdoor temperature

- The current drops when outdoor temperature becomes higher than a certain level (depending on the model).

4.7 Freeze-up Protection Control

Outline

During cooling operation, the signals sent from the indoor units control the operating frequency limitation and prevent freezing of the indoor heat exchanger. (The signals from the indoor units are divided into zones.)

Details

The operating frequency limitation is judged with the indoor heat exchanger temperature 2 seconds after operation starts and 30 seconds after the number of operation room is changed.

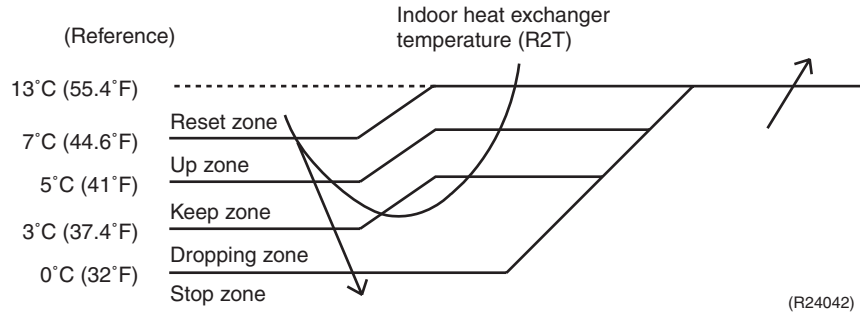

4.8 Heating Peak-cut Control

Outline

During heating operation, the indoor heat exchanger temperature determines the frequency upper limit to prevent abnormal high pressure.

Details

- The operating frequency is judged with the indoor heat exchanger temperature 2 minutes after the operation starts and F seconds after the number of operation room is changed.
- The maximum value of the indoor heat exchanger temperature controls the following (excluding stopped rooms).

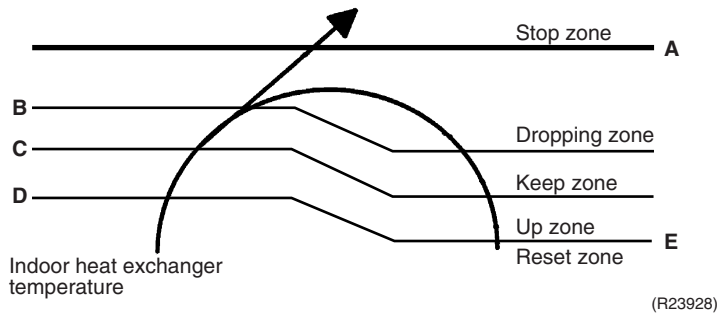

A	65°C (149°F)
B	55°C (131°F)
C	54°C (129.2°F)
D	52°C (125.6°F)
E	50°C (122°F)

	F (seconds)
When increase	30
When decrease	2

Zone	Control
Stop zone	When the temperature reaches the stop zone, the compressor stops.
Dropping zone	The upper limit of frequency decreases.
Keep zone	The upper limit of frequency is kept.
Up zone	The upper limit of frequency increases.
Reset zone	The upper limit of frequency is canceled.

4.9 Outdoor Fan Control

1. Fan ON control to cool down the electrical box

The outdoor fan is turned ON when the electrical box temperature is high while the compressor is OFF.

2. Fan OFF control during defrosting

The outdoor fan is turned OFF while defrosting.

3. Fan OFF delay when stopped

The outdoor fan is turned OFF 60 seconds after the compressor stops.

4. Fan speed control for pressure difference upkeep

The rotation speed of the outdoor fan is controlled for keeping the pressure difference during cooling operation with low outdoor temperature.

- When the pressure difference is low, the rotation speed of the outdoor fan is reduced.
- When the pressure difference is high, the rotation speed of the outdoor fan is controlled as well as normal operation.

5. Fan control when the number of heating room decreases

When the outdoor temperature is more than 10°C (50°F), the fan is turned off for 30 seconds.

6. Fan speed control during forced operation

The outdoor fan is controlled as well as normal operation during the forced operation.

7. Fan speed control during POWERFUL operation

The rotation speed of the outdoor fan is increased during the POWERFUL operation.

8. Fan speed control during indoor/outdoor unit quiet operation

The rotation speed of the outdoor fan is reduced by the command of the indoor/outdoor unit quiet operation.

9. Fan ON/OFF control when operation (cooling, heating, dry) starts/stops

The outdoor fan is turned ON when the operation starts. The outdoor fan is turned OFF when the operation stops.

4.10 Liquid Compression Protection Function

Outline

The compressor stops according to the outdoor temperature for protection.

Details

Operation stops depending on the outdoor temperature.

The compressor turns off under the conditions that the system is in cooling operation and the outdoor temperature is below -12°C (10.4°F).

4.11 Defrost Control

Outline

Defrosting is carried out by the cooling cycle (reverse cycle). The defrosting time or outdoor heat exchanger temperature must be more than a certain value to finish defrosting.

Details

Conditions for Starting Defrost

- The starting conditions are determined with the outdoor temperature and the outdoor heat exchanger temperature.
- The system is in heating operation.
- The compressor operates for 6 minutes.
- More than **A** minutes of accumulated time have passed since the start of the operation, or ending the previous defrosting.

Conditions for Canceling Defrost

The judgment is made with the outdoor heat exchanger temperature. (**B**°C (**C**°F))

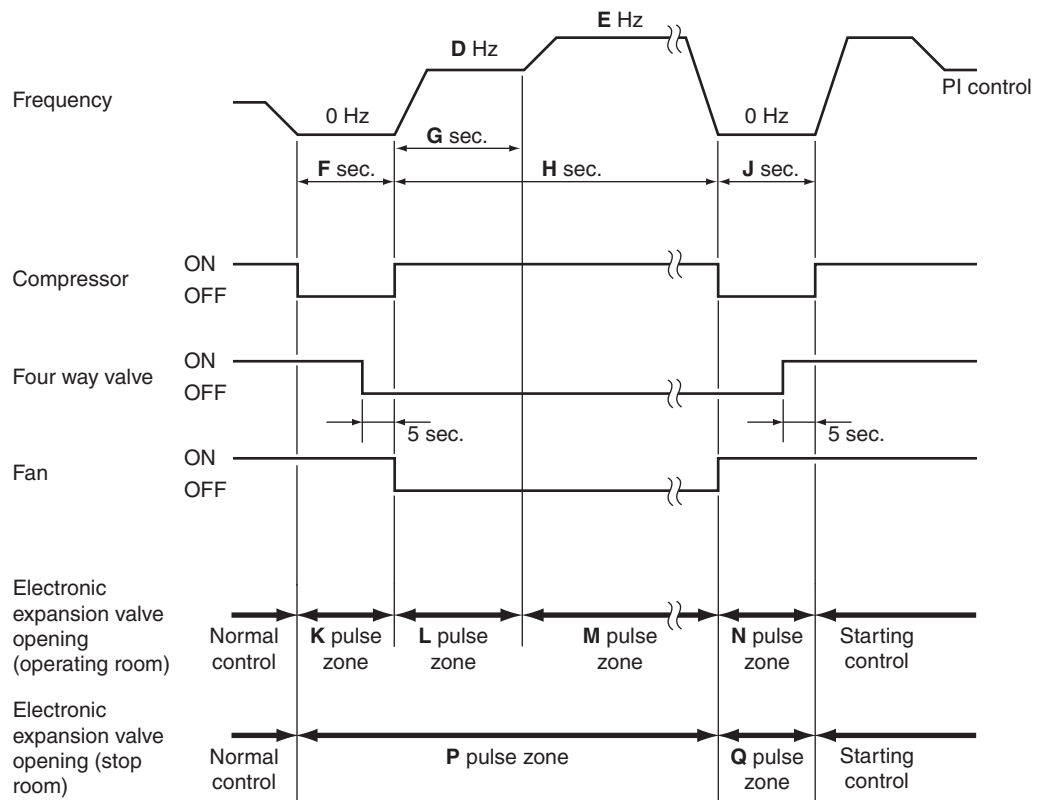

	18 class	24/36 class
A (minutes)	33	26
B (°C)	4 ~ 12	4 ~ 12
C (°F)	39.2 ~ 53.6	39.2 ~ 53.6
D (Hz)	58	58
E (Hz)	74	42
F (seconds)	60	90
G (seconds)	120	60
H (seconds)	650	590
J (seconds)	80	40
K (pulse)	320	400
L (pulse)	300	250
M (pulse)	300	300
N (pulse)	320	400
P (pulse)	160	50
Q (pulse)	160	0

4.12 Low Hz High Pressure Limit

Outline

The system controls the upper limit of the frequency to prevent abnormal high pressure while the frequency is low. Control is carried out according to three zones.

Details

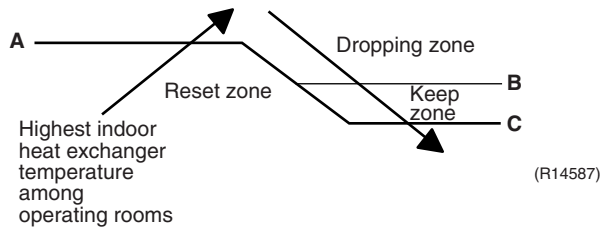

	18 class	24/36 class
A	60°C (140°F)	38.5°C (101.3°F)
B	59°C (138.2°F)	37.5°C (99.5°F)
C	56°C (132.8°F)	34.5°C (94.1°F)

4.13 Electronic Expansion Valve Control

Outline

The following items are included in the electronic expansion valve control.

Electronic expansion valve is fully closed

1. Electronic expansion valve is fully closed when turning on the power.
2. Pressure equalizing control

Room Distribution Control

1. Gas pipe isothermal control
2. SC (subcooling) control
3. Liquid pipe temperature control (with all ports connected and all rooms being air-conditioned)
4. Liquid pipe temperature control for stopped rooms
5. Dew prevention control for indoor rotor

Open Control

1. Electronic expansion valve control when starting operation
2. Electronic expansion valve control when the frequency changes
3. Electronic expansion valve control for defrosting
4. Electronic expansion valve control for oil recovery
5. Electronic expansion valve control when a discharge pipe temperature is abnormally high
6. Electronic expansion valve control when the discharge pipe thermistor is disconnected
7. Electronic expansion valve control for indoor unit freeze-up protection

Feedback Control

Target discharge pipe temperature control

Details

The following are the examples of electronic expansion valve control which function in each operation mode.

Operation pattern		Gas pipe isothermal control	SC (subcooling) control	Control when the frequency changes	Control for abnormally high discharge pipe temperature	Oil recovery control	Indoor freeze-up protection control	Liquid pipe temperature control	Liquid pipe temperature control for non-operating units	Dew prevention control for indoor rotor
When power is turned on	● : Available — : Not available									
↓	Fully closed when power is turned on	—	—	—	—	—	—	—	—	—
↓	Cooling, 1 room operation									
↓	Open control when starting	—	—	—	●	●	●	—	—	—
↓	(Control of target discharge pipe temperature)	—	—	●	●	●	●	—	—	●
↓	Cooling, 2 rooms operation to Cooling, 4 rooms operation									
↓	Control when the operating room is changed	—	—	—	●	●	●	—	—	●
↓	(Control of target discharge pipe temperature)	●	—	●	●	●	●	—	—	●
↓	Stop									
↓	Pressure equalizing control	—	—	—	—	—	—	—	—	—
↓	Heating, 1 room operation									
↓	Open control when starting	—	—	—	●	—	—	—	—	—
↓	(Control of target discharge pipe temperature)	—	★2	●	●	—	—	★1	★3	—
↓	Heating, 2 rooms operation									
↓	Control when the operating room is changed	—	—	—	●	—	—	—	—	—
↓	(Control of target discharge pipe temperature)	—	★2	●	●	—	—	★1	★3	—
↓	(Defrost control)	—	—	—	—	—	—	—	—	—
↓	Stop									
↓	Pressure equalizing control	—	—	—	—	—	—	—	—	—
↓	Heating operation									
↓	Open control when starting	—	—	—	●	—	—	—	—	—
↓	Discharge pipe thermistor disconnection control									
↓	Continue	—	●★2	—	—	—	—	●★1	●★3	—
↓	Stop									
↓	Pressure equalizing control	—	—	—	—	—	—	—	—	—

(R21181)

- ★1 : When all the indoor units are operating, liquid pipe temperature control is conducted.
- ★2 : SC (subcooling) control is conducted for the operating indoor units, when some of the units are not operating.
- ★3 : Liquid pipe temperature control for stopped room is conducted for the non-operating indoor units.

4.13.1 Initialization as Power Supply On

The electronic expansion valve is initialized (fully closed) when the power is turned on. Then, the valve opening is set and the pressure is equalized.

4.13.2 Pressure Equalizing Control

When the compressor is stopped, the pressure equalizing control is activated. The electronic expansion valve opens, and develops the pressure equalization.

4.13.3 Opening Limit Control

Outline

The maximum and minimum opening of the electronic expansion valve are limited.

Details

- Maximum electronic expansion valve opening in the operating room: 450 pulse
 - Minimum electronic expansion valve opening in the operating room: 64 pulse
- The electronic expansion valve is fully closed in a room where cooling operation is stopped and is opened at a fixed degree during defrosting.

4.13.4 Starting Operation Control/Changing Operation Room

The electronic expansion valve opening is controlled when the operation starts, and prevents superheating or liquid compression.

4.13.5 Control when the Frequency Changes

When the target discharge pipe temperature control is active, if the target frequency is changed to a specified value in a certain period of time, the target discharge pipe temperature control is canceled and the target opening of the electronic expansion valve is changed.

4.13.6 Oil Recovery Function

Outline

The electronic expansion valve opening in the cooling stopped room is set as to open for a certain time at a specified interval so that the oil in the cooling stopped room may not be accumulated.

Details

During cooling operation, every 1 hour continuous operation, the electronic expansion valves in the operation stopped room is opened by 80 pulses for specified time.

4.13.7 High Discharge Pipe Temperature Control

When the compressor is operating, if the discharge pipe temperature exceeds a certain value, the electronic expansion valve opens and the refrigerant runs to the low pressure side. This procedure lowers the discharge pipe temperature.

4.13.8 Discharge Pipe Thermistor Disconnection Control

Outline

The disconnection of the discharge pipe thermistor is detected by comparing the discharge pipe temperature with the condensing temperature. If the discharge pipe thermistor is disconnected, the electronic expansion valve opens according to the outdoor temperature and the operation frequency, operates for a specified time, and then stops.

After 3 minutes, the operation restarts and checks if the discharge pipe thermistor is disconnected. If the discharge pipe thermistor is disconnected, the system stops after operating for a specified time.

If the disconnection is detected repeatedly, the system is shut down. When the compressor runs for 60 minutes without any error, the error counter is reset.

Details

Determining thermistor disconnection

When the starting control (660 ~ 690 seconds, depending on the model) finishes, the following adjustment is made.

1. When the operation mode is cooling

When the following condition is fulfilled, the discharge pipe thermistor disconnection is ascertained.

Discharge pipe temperature + 6°C (10.8°F) < outdoor heat exchanger temperature

2. When the operation mode is heating

When the following condition is fulfilled, the discharge pipe thermistor disconnection is ascertained.

Discharge pipe temperature + 6°C (10.8°F) < highest indoor heat exchanger temperature

When the thermistor is disconnected

When the disconnection is ascertained, the compressor continues operation for 9 minutes and then stops.

4.13.9 Gas Pipe Isothermal Control During Cooling

When the units are operating in multiple rooms, the gas pipe temperature is detected and the electronic expansion valve opening is adjusted so that the temperature of the gas pipe in each room becomes equal.

- When the gas pipe temperature > the average gas pipe temperature,
→ the opening degree of electronic expansion valve in the corresponding room increases.
- When the gas pipe temperature < the average gas pipe temperature,
→ the opening degree of electronic expansion valve in the corresponding room decreases.

The temperatures are monitored every 40 seconds.

4.13.10 SC (Subcooling) Control

Outline

The liquid pipe temperature and the heat exchanger temperature are detected and the electronic expansion valve opening is compensated so that the SC of each room becomes the target SC.

- When the actual SC is > target SC, open the electronic expansion valve of the room.
- When the actual SC is < target SC, close the electronic expansion valve of the room.

Details

Start Conditions

After finishing the starting control (660 ~ 690 seconds, depending on the model), (all) the electronic expansion valve(s) for the operating room is/are controlled.

Determine Electronic Expansion Valve Opening

The electronic expansion valve opening is adjusted so that the temperature difference between the maximum heat exchanger temperature of connected room and the liquid pipe temperature thermistor becomes constant.

4.13.11 Target Discharge Pipe Temperature Control

The target discharge pipe temperature is obtained from the indoor and outdoor heat exchanger temperature, and the electronic expansion valve opening is adjusted so that the actual discharge pipe temperature becomes close to the target discharge pipe temperature. (Indirect SH (superheating) control using the discharge pipe temperature)

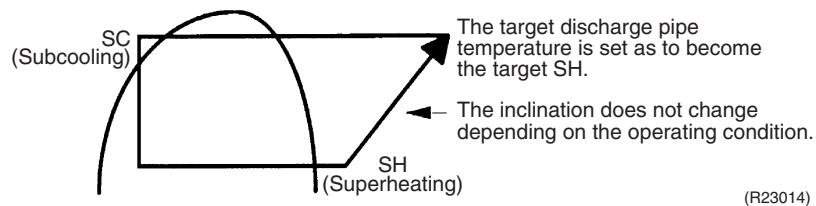

(R23014)

The electronic expansion valve opening and the target discharge pipe temperature are adjusted every 20 seconds. The target discharge pipe temperature is controlled by indoor heat exchanger temperature and outdoor heat exchanger temperature. The opening degree of the electronic expansion valve is controlled by the following.

- ◆ Target discharge pipe temperature
- ◆ Actual discharge pipe temperature
- ◆ Previous discharge pipe temperature

4.14 Malfunctions

4.14.1 Sensor Malfunction Detection

Sensor malfunction may occur either in the thermistor or current transformer (CT) system.

Relating to Thermistor Malfunction

1. Outdoor heat exchanger thermistor
2. Discharge pipe thermistor
3. Radiation fin thermistor
4. Gas pipe thermistor
5. Outdoor temperature thermistor
6. Liquid pipe thermistor



Relating to CT Malfunction

Refer to CT or related abnormality on page 183 for details.

4.14.2 Detection of Overcurrent and Overload

Outline

In order to protect the inverter, an excessive output current is detected and the OL temperature is observed to protect the compressor.

Details

- If the inverter current exceeds 13.0 ~ 18.5 A (depending on the model), the system shuts down the compressor.
- If the OL (compressor head) temperature exceeds 130°C (266°F), the compressor stops.

4.14.3 Refrigerant Shortage Control

Outline

If the power consumption is below the specified value and the frequency is higher than the specified frequency, it is regarded as refrigerant shortage. The power consumption is low comparing with that in the normal operation when refrigerant is insufficient, and refrigerant shortage is detected by checking power consumption.

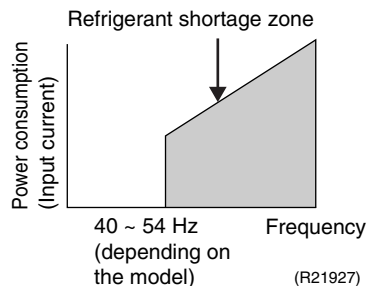

Refer to refrigerant shortage on page 161 for details.

4.14.4 Anti-icing Function

During cooling, if the indoor heat exchanger temperature in the operation stopped room drops below the specified temperature for a specified time, the electronic expansion valve is opened in the operation stopped room as specified, and the fully closed operation is carried out. After this, if freezing abnormality occurs longer than a specified time, the system is shut down.

Part 5

Remote Controller

- 1. Applicable Remote Controller 99
- 2. ARC466A36 100
- 3. ARC452A21 102
- 4. ARC452A23 104
- 5. ARC466A21 106
- 6. BRC1E73 (Wired Remote Controller) 108
- 7. BRC082A41W, BRC082A42W(S) (Wireless Remote Controller Kit) 114

1. Applicable Remote Controller

Model Name	Remote Controller	Reference Page
CTXG09QVJUW(S)	ARC466A36	100
CTXG12QVJUW(S)		
CTXG18QVJUW(S)		
CTXS07LVJU	ARC452A21	102
FTXS09LVJU		
FTXS12LVJU		
FTXS15LVJU		
FTXS18LVJU		
FTXS24LVJU		
FDXS09LVJU	ARC452A23	104
FDXS12LVJU		
CDXS15LVJU		
CDXS18LVJU		
CDXS24LVJU		
FVXS09NVJU	ARC466A21	106
FVXS12NVJU		
FVXS15NVJU		
FVXS18NVJU		
FFQ09Q2VJU	<ul style="list-style-type: none"> ■ Wired Remote Controller BRC1E73 ■ Wireless Remote Controller BRC082A41W BRC082A42W(S) 	<ul style="list-style-type: none"> ■ Wired Remote Controller 108 ■ Wireless Remote Controller 114
FFQ12Q2VJU		
FFQ15Q2VJU		
FFQ18Q2VJU		

2. ARC466A36

Signal transmitter

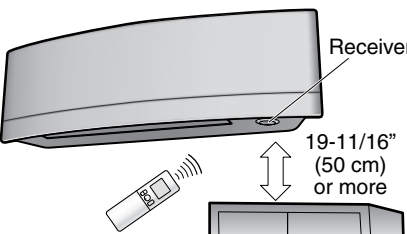

Receiver

19-11/16"
(50 cm)
or more

- To use the remote controller, aim the transmitter at the indoor unit. If there is anything to block signals between the unit and the remote controller, such as a curtain, the unit will not operate.
- The maximum distance for communication is about 19-11/16 ft (6 m).
Make sure that there are no obstacles within 19-11/16 inch (50 cm) under the signal receiver. Such obstacles, if any, may have an adverse influence on the reception performance of the receiver and the reception distance may be shortened.

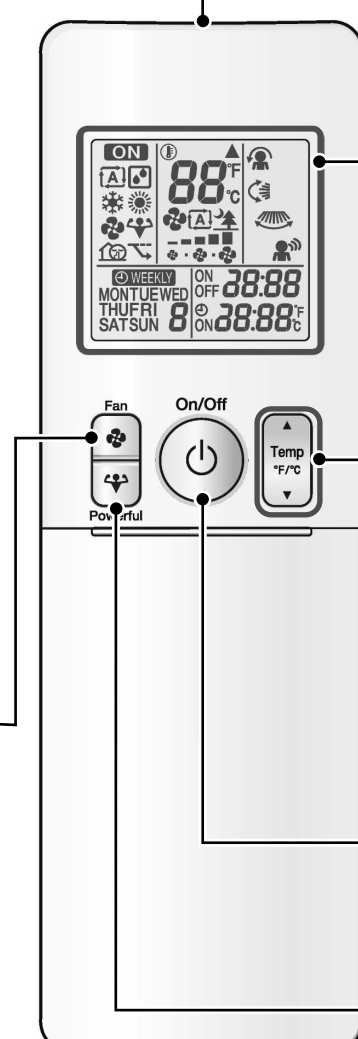

Display (LCD)

- Displays the current settings.
(In this illustration, each section is shown with all its displays on for the purpose of explanation.)

Temperature adjustment buttons

- Changes the temperature setting.

[A] : AUTO	18 ~ 30 °C (64 ~ 86 °F)
[D] : DRY	Not available
[S] : COOL	18 ~ 32 °C (64 ~ 90 °F)
[H] : HEAT	10 ~ 30 °C (50 ~ 86 °F)
[F] : FAN	Not available

On/Off button

- Press this button once to start operation.
Press once again to stop it.

Powerful*1 button

- Starts POWERFUL operation.

< ARC466A36 >

(R24594)

Fan setting button

- Selects the airflow rate setting.

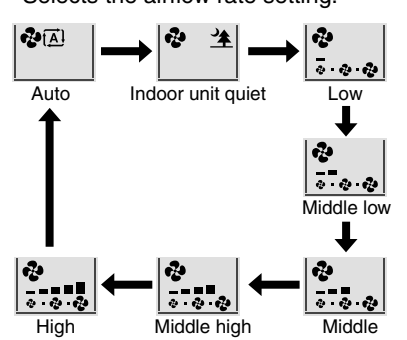

- In indoor unit quiet operation, operation sound becomes weak. (The airflow rate also decreases.)
- In DRY operation, the airflow rate setting is not available.

Reference

Refer to the following pages for details.

★1 POWERFUL operation P.54

Open the Front Cover

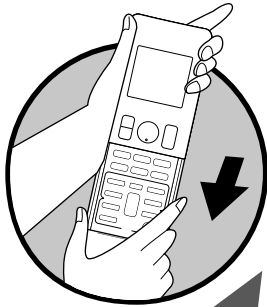

Mode button

- Selects the operation mode.

Lamp brightness setting button

- Each time you press **Brightness** button, the brightness of the indoor unit display changes to high, low, or off.

Comfort/Sensor button (COMFORT AIRFLOW Operation*2/ INTELLIGENT EYE Operation*3)

- Every time you press **Comfort/Sensor** button, the setting changes in the following order.

Off Timer button (NIGHT SET mode)

- Press this button and adjust the day and time with **Select** button.
- Press this button again to complete **TIMER** setting.

Timer Cancel button

- Cancels the timer setting.
- It cannot be used for the **WEEKLY TIMER** operation.

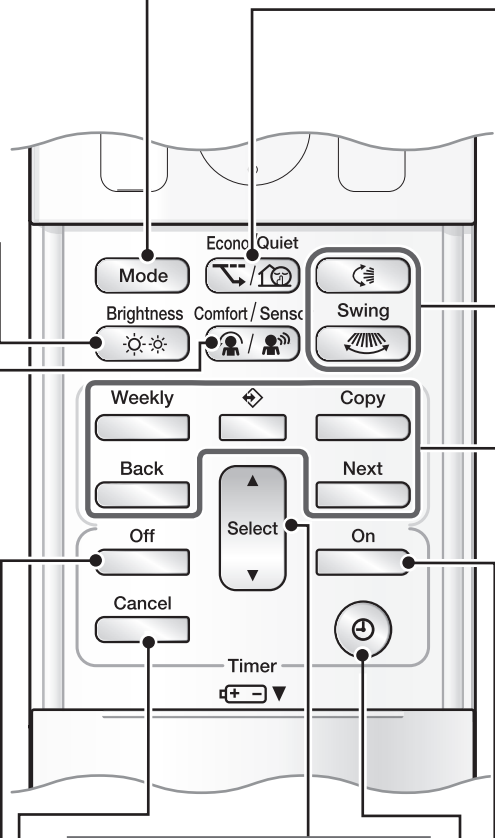

Econo*4 / Quiet button

- Every time you press **Econo/Quiet** button, the setting changes in the following order.

- **OUTDOOR UNIT QUIET** operation is not available in **FAN** and **DRY** operation.
- **OUTDOOR UNIT QUIET** operation and **ECONO** operation cannot be used at the same time with **POWERFUL** operation. Priority is given to the function you pressed last.

Swing*5 buttons

- Adjusts the airflow direction.
- When you press **Swing** button, the flap moves up and down, or (and) the louver moves right and left. The flap (louver) stops when you press **Swing** button again.

Select button

- Changes the **ON/OFF TIMER** and **WEEKLY TIMER** settings.

Clock*7 button

On Timer button

- Press this button and adjust the day and time with **Select** button.
- Press this button again to complete **TIMER** setting.

Weekly button (WEEKLY TIMER Operation*6)

- Weekly
- : Weekly button
- : Program button
- Copy
- : Copy button
- Back
- : Back button
- Next
- : Next button

(R24616)

Reference

Refer to the following pages for details.

- ★2 COMFORT AIRFLOW operation P.43, 45
- ★3 2-area INTELLIGENT EYE operation..... P.51
- ★4 ECONO operation..... P.50
- ★5 Auto-swing P.42
- ★6 WEEKLY TIMER operation..... P.57
- ★7 Clock setting P.56

3. ARC452A21

Signal transmitter

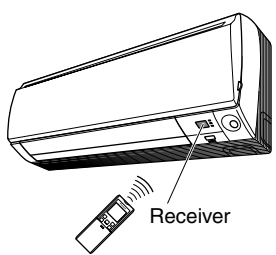

- To use the remote controller, aim the transmitter at the indoor unit. If there is anything to block signals between the unit and the remote controller, such as a curtain, the unit will not operate.
- Do not drop the remote controller. Do not get it wet.
- The maximum distance for communication is approximately 23 ft. (7 m).

FAN setting button

- Selects the airflow rate setting every time you press this button.

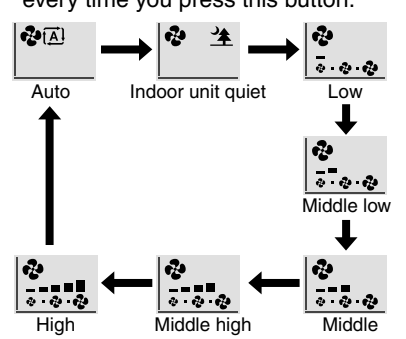

- In indoor unit quiet operation, operation sound becomes weak. (The airflow rate also decreases.)
- In DRY operation, the airflow rate setting is not available.

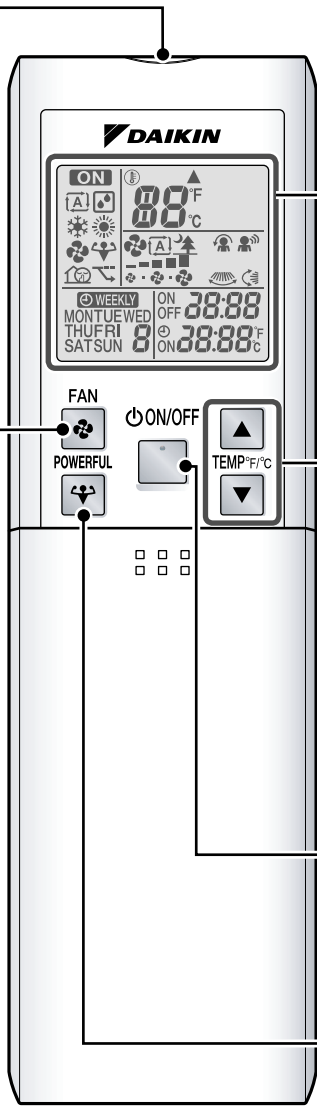

Display (LCD)

- Displays the current settings. (In this illustration, each section is shown with all its displays on for the purpose of explanation.)

TEMPERATURE adjustment buttons

- Changes the temperature setting.

Ⓐ : AUTO	18 ~ 30 °C (64 ~ 86 °F)
☐ : DRY	Not available
☼ : COOL	18 ~ 32 °C (64 ~ 90 °F)
☀ : HEAT	10 ~ 30 °C (50 ~ 86 °F)
☼ : FAN	Not available

ON/OFF button

- Press this button once to start operation. Press once again to stop it.

POWERFUL*1 button

- Starts POWERFUL operation.

< ARC452A21 >

(R24595)

Reference

Refer to the following pages for details.

★1 POWERFUL operation P.54

Open the Front Cover

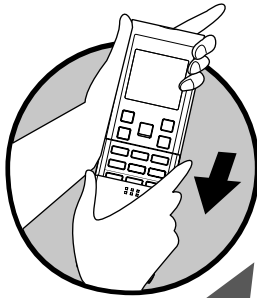

MODE button

- Selects the operation mode.



ECONO*4 button

- Starts ECONO operation.

SWING*5 buttons

- Adjusts the airflow direction.
- When you press **SWING** button, the flap moves up and down, or (and) the louver moves right and left. The flap (louver) stops when you press **SWING** button again.

QUIET button

- OUTDOOR UNIT QUIET operation.
- OUTDOOR UNIT QUIET operation is not available in FAN and DRY operation.
- OUTDOOR UNIT QUIET operation and POWERFUL operation cannot be used at the same time. Priority is given to the function you pressed last.

COMFORT*2/SENSOR*3 button

- Every time you press **COMFORT/SENSOR** button, the setting changes in the following order.

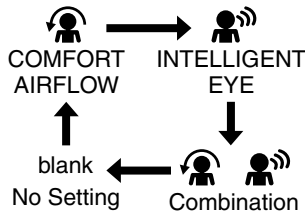

WEEKLY button (WEEKLY TIMER Operation*6)

- WEEKLY : WEEKLY button
- PROGRAM button
- COPY : COPY button
- BACK : BACK button
- NEXT : NEXT button

ON TIMER button

- Press this button and adjust the day and time with **SELECT** button.
- Press this button again to complete **TIMER** setting.

OFF TIMER button (NIGHT SET mode)

- Press this button and adjust the day and time with **SELECT** button.
- Press this button again to complete **TIMER** setting.

TIMER CANCEL button

- Cancels the timer setting.
- Cannot be used for the **WEEKLY TIMER** operation.

CLOCK*7 button

SELECT button

- Changes the ON/OFF **TIMER** and **WEEKLY TIMER** settings.

(R24617)

Reference

Refer to the following pages for details.

★2 COMFORT AIRFLOW operation	P.43, 45
★3 INTELLIGENT EYE operation	P.53
★4 ECONO operation.....	P.50
★5 Auto-swing.....	P.42
★6 WEEKLY TIMER operation.....	P.57
★7 Clock setting	P.56

4. ARC452A23

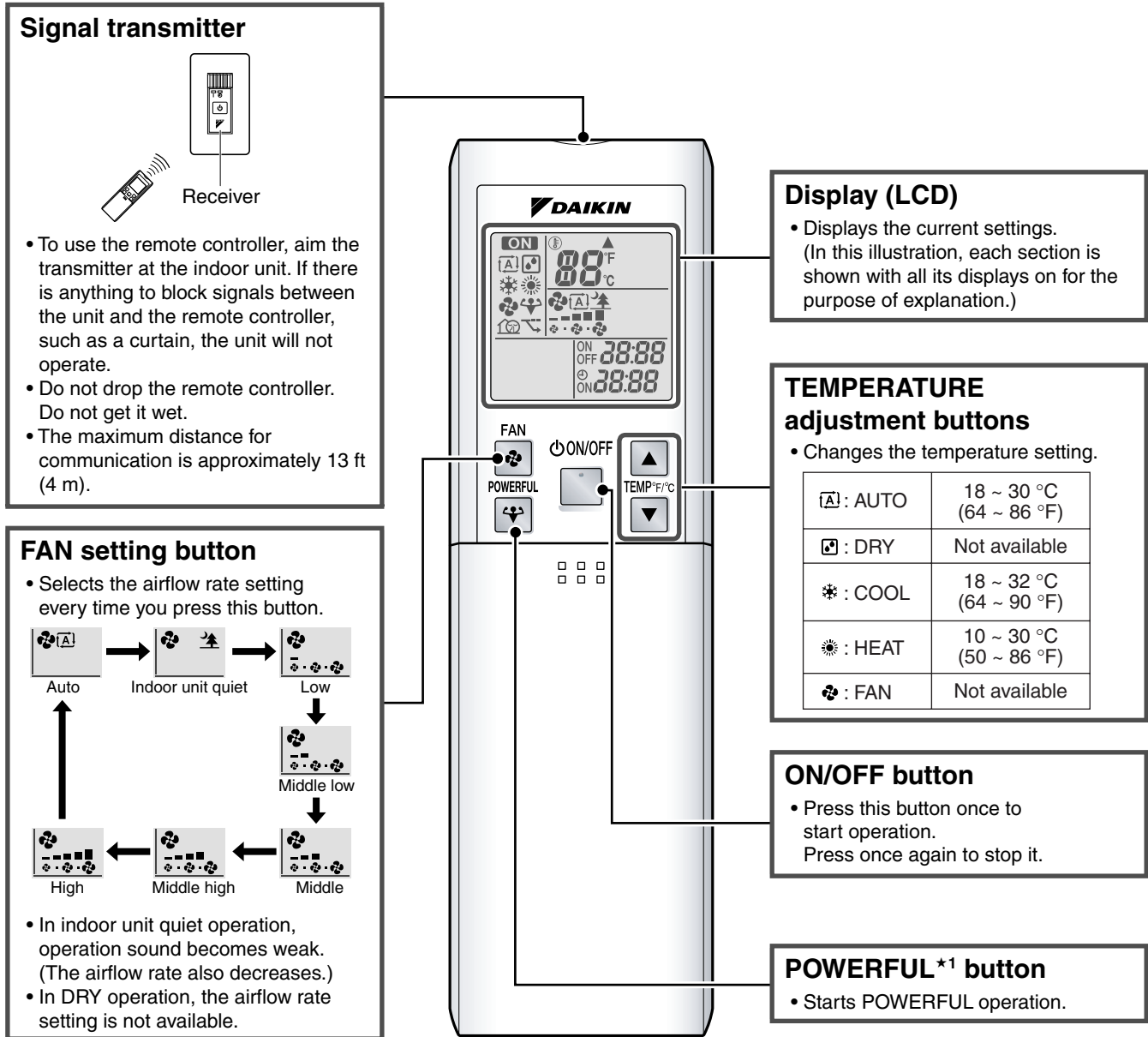

< ARC452A23 >

(R24596)

Reference

Refer to the following pages for details.
 ★1 POWERFUL operationP.54

Open the Front Cover

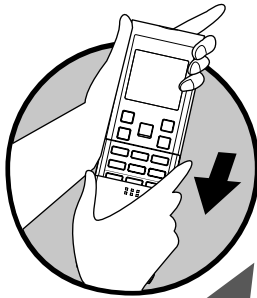

MODE button

- Selects the operation mode.

QUIET button

- OUTDOOR UNIT QUIET operation.
- OUTDOOR UNIT QUIET operation is not available in FAN and DRY operation.
- OUTDOOR UNIT QUIET operation and POWERFUL operation cannot be used at the same time. Priority is given to the function you pressed last.

OFF TIMER button (NIGHT SET mode)

- Press this button and adjust the time with **SELECT** button. Press this button again to complete TIMER setting.

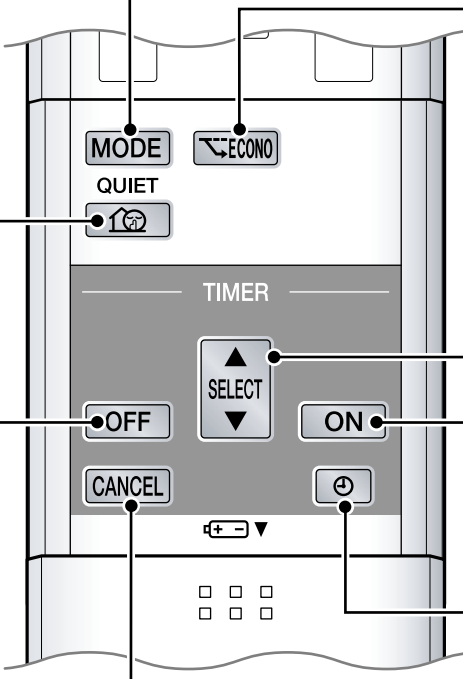

ECONO*2 button

- Starts ECONO operation.

SELECT button

- Changes the ON/OFF TIMER settings.

ON TIMER button

- Press this button and adjust the time with **SELECT** button. Press this button again to complete TIMER setting.

CLOCK*3 button

TIMER CANCEL button

- Cancels the timer setting.

(R24618)

Reference

Refer to the following pages for details.

★2 ECONO operation.....	P.50
★3 Clock setting.....	P.56

5. ARC466A21

Signal transmitter

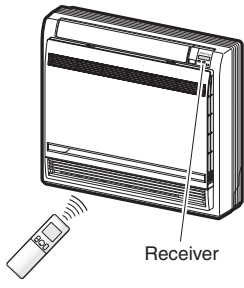

- To use the remote controller, aim the transmitter at the indoor unit. If there is anything blocking the signals between the unit and the remote controller, such as a curtain, the unit may not operate.
- The maximum transmission distance is about 23 ft (7 m).

Fan setting button

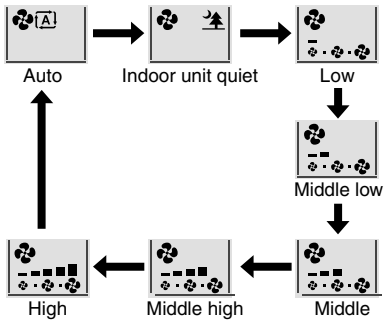

- Selects the airflow rate setting every time you press this button.
- In indoor unit quiet operation, operation sound becomes weak. (The airflow rate also decreases.)
- In DRY operation, the airflow rate setting is not available.

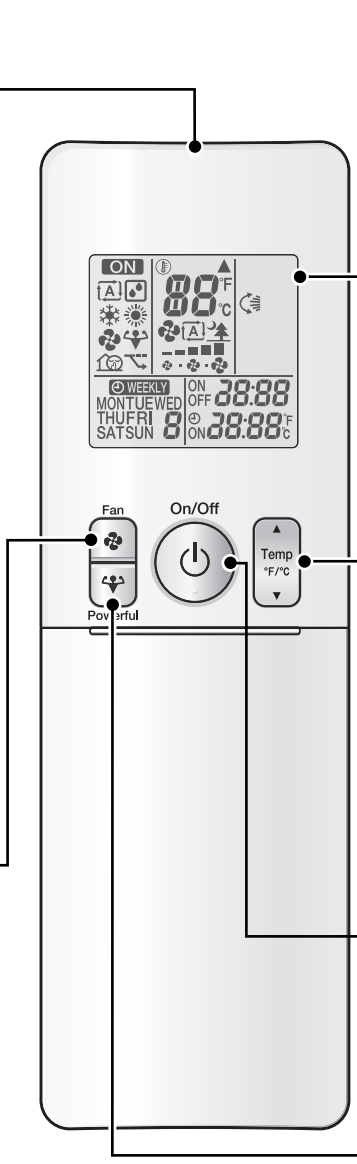

Display (LCD)

- Displays the current settings. (In this illustration, each section is shown with all its displays on for the purpose of explanation.)

Temperature adjustment buttons

- Changes the temperature setting.

Ⓐ : AUTO	18 ~ 30 °C (64 ~ 86 °F)
☐ : DRY	Not available
✳ : COOL	18 ~ 32 °C (64 ~ 90 °F)
☀ : HEAT	10 ~ 30 °C (50 ~ 86 °F)
⊗ : FAN	Not available

On/Off button

- Press this button once to start operation. Press once again to stop it.

Powerful*1 button

- Starts POWERFUL operation.

< ARC466A21 >

(R24597)

Reference

Refer to the following pages for details.

★1 POWERFUL operation P.54

Open the Front Cover

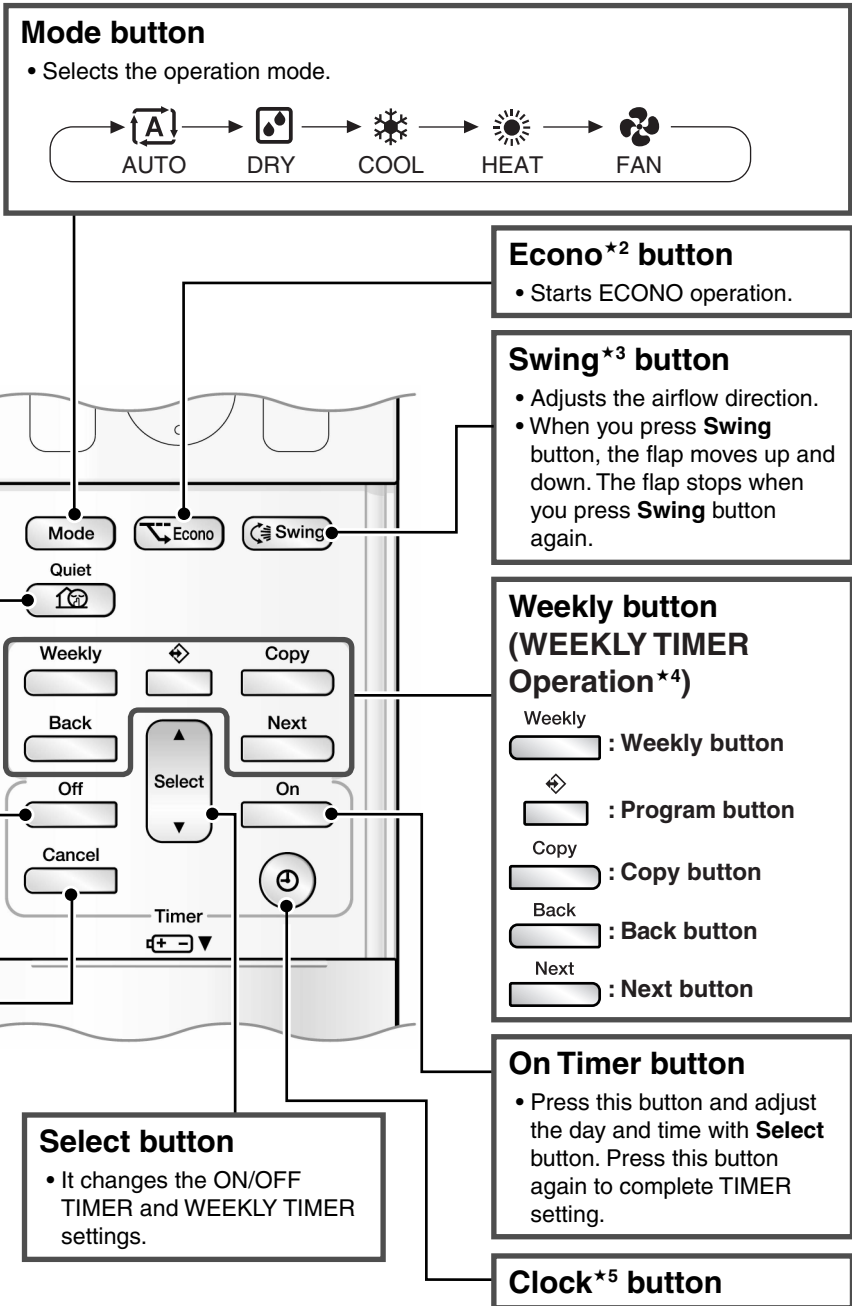
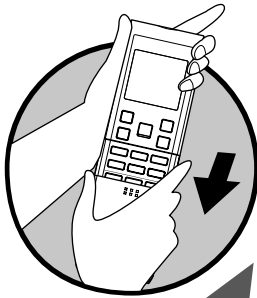

(R24619)

Reference

Refer to the following pages for details.

★2 ECONO operation.....	P.50
★3 Auto-swing.....	P.42
★4 WEEKLY TIMER operation.....	P.57
★5 Clock setting.....	P.56

6. BRC1E73 (Wired Remote Controller)

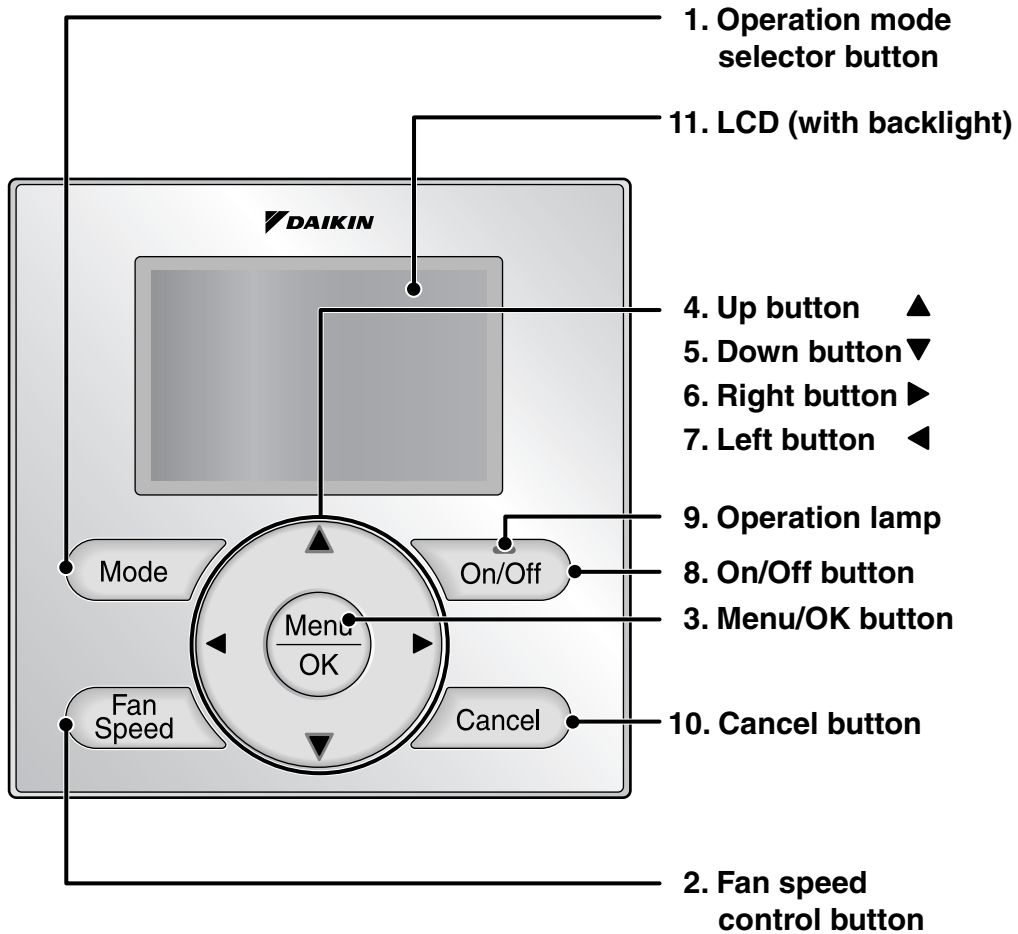

1. Operation mode selector button

- Press this button to select the operation mode of your preference.
* Available modes vary with the indoor unit model.

2. Fan speed control button

- Press this button to select the fan speed of your preference.
* Available fan speeds vary with the indoor unit model.

3. Menu/OK button

- Used to enter the main menu.
- Used to enter the selected item.

4. Up button ▲

- Used to raise the setpoint.
- The item above the current selection will be highlighted.
(The highlighted items will be scrolled continuously when the button is continuously pressed.)
- Used to change the selected item.

5. Down button ▼

- Used to lower the setpoint.
- The item below the current selection will be highlighted.
(The highlighted items will be scrolled continuously when the button is continuously pressed.)
- Used to change the selected item.

6. Right button ►

- Used to highlight the next items on the right-hand side.
- Each screen is scrolled in the right-hand direction.

7. Left button ◀

- Used to highlight the next items on the left-hand side.
- Each screen is scrolled in the left-hand direction.

8. On/Off button

- Press this button and system will start.
- Press this button again to stop the system.

9. Operation lamp

- This lamp illuminates solid green during normal operation.
- This lamp flashes if an error occurs.

10. Cancel button

- Used to return to the previous screen.

11. LCD (with backlight)

- The backlight will be illuminated for approximately 30 seconds by pressing any button.
- If two remote controllers are used to control a single indoor unit, only the controller accessed first will have backlight functionality.

Liquid Crystal Display

- Three types of display mode (Standard, Detailed and Simple) are available.
- Standard display is set by default.
- Detailed and Simple displays can be selected in the main menu.

Standard display

10. Changeover controlled by the master indoor unit

9. Under centralized control

1. Operation mode

2. Fan Speed

6. Ventilation

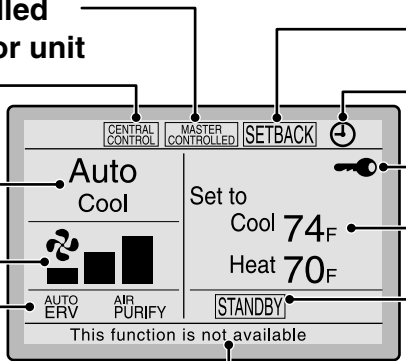

11. Setback

8. (⌚) Scheduled

7. (🔒) Key Lock

3. Setpoint

4. Stand by for Defrost/ Hot start

5. Message

<Standard display example>

Detailed display

- The airflow direction, clock, and selectable item appear on Detailed display screen in addition to the items appearing on Standard display.

12. Airflow Direction (Displayed only when the indoor unit is turned on.)

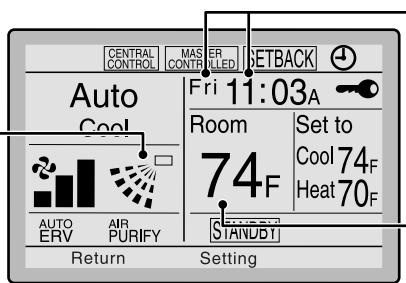

13. Current Day/Time (12/24 hour time display)

14. Selectable Display Item

<Detailed display example 1>

No Fan speed display (with no fan speed control function)

No Airflow Direction display (with no airflow direction settings)

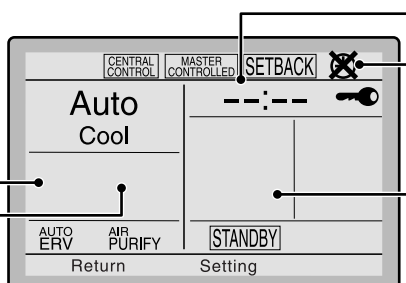

No Clock display (when the clock has not been set yet)

15. (X) Unable to schedule

No Selectable Display Item (with no selectable display item selected)

<Detailed display example 2>

Simple display

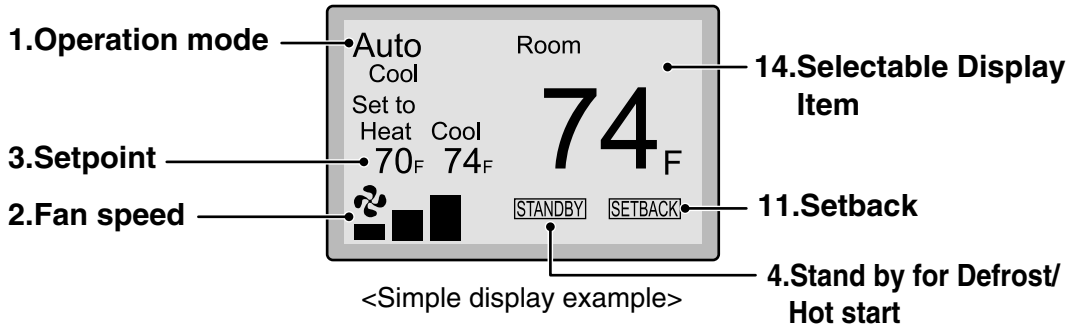

Note for all display modes

- Depending on the field settings, while the indoor unit is stopped, OFF may be displayed instead of the operation mode and/or the setpoint may not be displayed.

1. Operation mode

- Used to display the current operation mode: Cool, Heat, Vent, Fan, Dry or Auto.
- In Auto mode, the actual operation mode (Cool or Heat) will be also displayed.
- Operation mode cannot be changed when OFF is displayed.
Operation mode can be changed after starting operation.

2. Fan Speed

- Used to display the fan speed that is set for the indoor unit.
- The fan speed will not be displayed if the connected model does not have fan speed control functionality.

3. Setpoint

- Used to display the setpoint for the indoor unit.
- Use the Celsius/Fahrenheit item in the main menu to select the temperature unit (Celsius or Fahrenheit).

4. Stand by for Defrost/Hot start

“”

If ventilation icon is displayed in this field:

- Indicates that an energy recovery ventilator (ERV) is connected.
For details, refer to the Operation Manual of the ERV.

5. Message

The following messages may be displayed.

“**This function is not available**”

- Displayed for a few seconds when an Operation button is pressed and the indoor unit does not provide the corresponding function.
- In a remote control group, the message will not appear if at least one of the indoor units provides the corresponding function.

“**Error: Push Menu button**”

“**Warning: Push Menu button**”

- Displayed if an error or warning is detected.



“**Time to clean filter**”

“**Time to clean element**”

“**Time to clean filter & element**”

- Displayed as a reminder when it is time to clean the filter and/or element.

6. Ventilation

- Displayed when an energy recovery ventilator is connected.
- **Ventilation Mode icon.** “ AUTO ERV BYPASS”
These icons indicate the current ventilation mode (ERV only) (AUTO, ERV, BYPASS).
- **Air Purify ICON** “ AIR PURIFY”
This icon indicates that the air purifying unit (Optional) is in operation.

7. Key Lock

- Displayed when the key lock is set.

8. Scheduled

- Displayed if the Schedule or Off timer is enabled.

9. Under Centralized control “”

- Displayed if the system is under the management of a multi-zone controller (Optional) and the operation of the system through the remote controller is limited.

10. Changeover controlled by the master indoor unit “” (VRV only)

- Displayed when another indoor unit on the system has the authority to change the operation mode between cool and heat.

11. Setback “”

- The setback icon flashes when the unit is turned on by the setback control.

12. Airflow Direction “”

- Displayed when the airflow direction and swing are set.
- If the connected indoor unit model does not include oscillating louvers this item will not be displayed.

13. Current Day/Time (12/24 hour time display)

- Displayed if the clock is set.
- If the clock is not set, “-- : --” will be displayed.
- 12 hour time format is displayed by default.
- Select 12/24 hour time display option in the main menu under “Clock & Calendar”.

14. Selectable Display Item

- Room temperature is selected by default.
- For other choices see the operation manual.

15. ~~X~~Unable to schedule

- Displayed when the clock needs to be set.
- The schedule function will not work unless the clock is set.



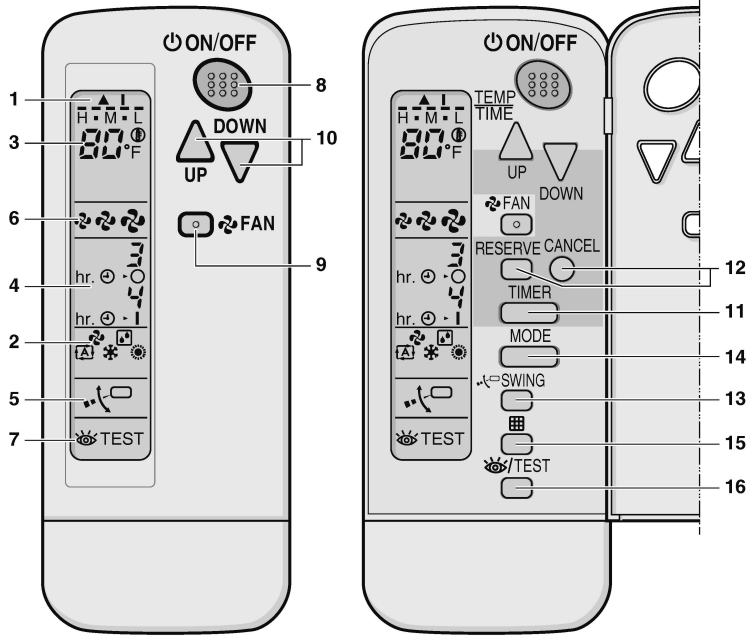



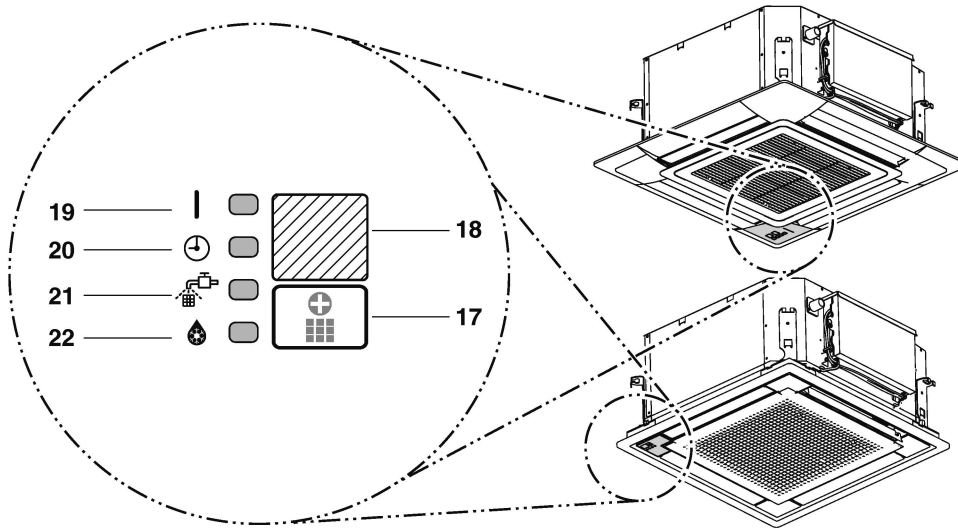







7. BRC082A41W, BRC082A42W(S) (Wireless Remote Controller Kit)



(R23936)



(R23937)

1	DISPLAY ▲ (SIGNAL TRANSMISSION) This lights up when a signal is being transmitted.
2	DISPLAY , , , ,  (OPERATION MODE) This display shows the current OPERATION MODE.
3	DISPLAY ^H·^M·^L ,  (SET TEMPERATURE) This display shows the set temperature.
4	DISPLAY hr.  hr.  (PROGRAMMED TIME) This display shows PROGRAMMED TIME of the system start or stop.
5	DISPLAY  (SWING FLAP)
6	DISPLAY , ,  (FAN SPEED) The display shows the set fan speed.
7	DISPLAY /TEST (INSPECTION/TEST OPERATION) When the INSPECTION/TEST OPERATION button is pressed, the display shows the system mode is in.
8	ON/OFF BUTTON Press the button and the system will start. Press the button again and the system will stop.
9	FAN SPEED CONTROL BUTTON Press this button to select the fan speed, LOW, MEDIUM or HIGH, of your choice.
10	TEMPERATURE SETTING BUTTON Use this button for setting temperature.

11	TIMER MODE START/STOP BUTTON
12	TIMER RESERVE/CANCEL BUTTON
13	AIRFLOW DIRECTION ADJUST BUTTON
14	OPERATION MODE SELECTOR BUTTON Press this button to select OPERATION MODE.
15	FILTER SIGN RESET BUTTON
16	INSPECTION/TEST OPERATION BUTTON This button is used only by qualified service persons for maintenance purposes.
17	EMERGENCY OPERATION SWITCH This switch is readily used if the remote controller does not work.
18	RECEIVER This receives the signals from the remote controller.
19	OPERATION LAMP (Red) This lamp stays lit while the air conditioner runs. It blinks when the unit is in trouble.
20	TIMER LAMP (Green) This lamp stays lit while the timer is set.
21	AIR FILTER CLEANING TIME INDICATOR LAMP (Red) Lights up when it is time to clean the air filter.
22	DEFROST LAMP (Orange) Lights up when the defrosting operation has started.

Part 6

Service Diagnosis

1. General Problem Symptoms and Check Items	118
2. Troubleshooting with LED	119
2.1 Indoor Unit.....	119
2.2 Outdoor Unit.....	121
3. Service Diagnosis	122
3.1 CTXG, CTXS, FTXS, CDXS, FDXS, FVXS Series	122
3.2 FFQ Series	128
4. Code Indication on Remote Controller	134
4.1 CTXG, CTXS, FTXS, CDXS, FDXS, FVXS Series	134
4.2 FFQ Series	134
4.3 Outdoor Unit.....	135
5. Troubleshooting for CTXG, CTXS, FTXS, CDXS, FDXS, FVXS Series.....	136
5.1 Indoor Unit PCB Abnormality	136
5.2 Freeze-up Protection Control/Heating Peak-cut Control	138
5.3 Indoor Fan Motor or Related Abnormality	139
5.4 Thermistor or Related Abnormality.....	143
5.5 Front Panel Open/Close Fault.....	144
5.6 Signal Transmission Error (Between Indoor Unit and Outdoor Unit).....	145
5.7 Mismatching of Indoor Unit and Outdoor Unit	147
6. Troubleshooting for FFQ Series	148
6.1 Indoor Unit PCB Abnormality	148
6.2 Drain Level Control System Abnormality.....	149
6.3 Indoor Fan Motor (DC Motor) or Related Abnormality	150
6.4 Humidifier or Related Abnormality.....	152
6.5 Thermistor or Related Abnormality.....	153
6.6 Presence Sensor or Floor Sensor Abnormality	154
6.7 Remote Controller Thermistor Abnormality	155
6.8 Signal Transmission Error (Between Indoor Unit and Outdoor Unit).....	156
6.9 Signal Transmission Error (Between Indoor Unit and Remote Controller)	158
6.10 Signal Transmission Error (Between MAIN Remote Controller and SUB Remote Controller)	159
6.11 Mismatching of Indoor Unit and Outdoor Unit	160
7. Troubleshooting for Outdoor Unit.....	161
7.1 Refrigerant Shortage	161
7.2 Low-voltage Detection or Over-voltage Detection.....	163
7.3 Wiring Error Check Unexecuted.....	165
7.4 Unspecified Voltage (Between Indoor Unit and Outdoor Unit)/ Anti-icing Control in Other Rooms.....	166
7.5 Anti-icing Control for Indoor Unit	167

7.6	Outdoor Unit PCB Abnormality.....	169
7.7	OL Activation (Compressor Overload)	170
7.8	Compressor Lock	172
7.9	DC Fan Lock	173
7.10	Input Overcurrent Detection	174
7.11	Four Way Valve Abnormality.....	175
7.12	Discharge Pipe Temperature Control.....	177
7.13	High Pressure Control in Cooling	178
7.14	Compressor Sensor System Abnormality	179
7.15	Position Sensor Abnormality	181
7.16	CT or Related Abnormality	183
7.17	Thermistor or Related Abnormality (Outdoor Unit).....	185
7.18	Electrical Box Temperature Rise.....	187
7.19	Radiation Fin Temperature Rise	188
7.20	Output Overcurrent Detection	189
8.	Check.....	191
8.1	Thermistor Resistance Check	191
8.2	Indoor Fan Motor Connector Check.....	192
8.3	Hall IC Check	192
8.4	Power Supply Waveform Check.....	193
8.5	Electronic Expansion Valve Check.....	194
8.6	Four Way Valve Performance Check.....	195
8.7	Inverter Unit Refrigerant System Check.....	195
8.8	Inverter Analyzer Check.....	196
8.9	Rotation Pulse Check on the Outdoor Unit PCB.....	197
8.10	Installation Condition Check.....	198
8.11	Discharge Pressure Check.....	198
8.12	Outdoor Fan System Check	199
8.13	Main Circuit Short Check.....	199
8.14	Capacitor Voltage Check.....	200
8.15	Power Module Check	201

1. General Problem Symptoms and Check Items

Problem Symptom	Check Item	Details	Reference Page
None of the units operates.	Check the power supply.	Check if the rated voltage is supplied.	—
	Check the types of the indoor units.	Check if the indoor unit type is compatible with the outdoor unit.	—
	Check the outdoor temperature.	Heating/cooling operations are not available when the outdoor temperature is out of the operation limit. Check the reference page for the operation limit.	243
	Diagnose with remote controller indication	—	134, 135
	For CTXG, CTXS, FTXS, CDXS, FDXS, FVXS Series: Check the remote controller addresses.	Check if address settings for the remote controller and indoor unit are correct.	216
	For FFQ Series: Check the wireless remote controller address. If using 2 remote controllers for 1 indoor unit, check MAIN/SUB setting.	Check if address settings for the wireless remote controller and indoor unit are correct. Check if the MAIN/SUB setting is correct.	158, 159
Operation sometimes stops.	Check the power supply.	A power failure of 2 to 10 cycles can stop air conditioner operation. (Operation lamp OFF)	—
	Check the outdoor temperature.	Heating/cooling operations are not available when the outdoor temperature is out of the operation limit. Check the reference page for the operation limit.	243
	Diagnose with remote controller indication.	—	134, 135
Some indoor units do not operate.	Check the type of the indoor units.	Check if the indoor unit type is compatible with the outdoor unit.	—
	Diagnose with remote controller indication	—	134, 135
Units operate but do not cool, or do not heat.	Check for wiring and piping errors in the connection between the indoor and outdoor units.	Check the piping. Conduct the wiring error check described on the product diagnosis nameplate.	—
	Check for thermistor detection errors.	Check if the thermistor is mounted securely.	—
	Check for faulty operation of the electronic expansion valve.	Set all the units to cooling operation, and compare the temperatures of the liquid pipes to see if the each electronic expansion valve works.	—
	Diagnose with remote controller indication.	—	134, 135
	Diagnose by service port pressure and operating current.	Check for refrigerant shortage.	161
Large operating noise and vibrations	Check the output voltage of the power module.	—	201
	Check the power module.	—	—
	Check the installation condition.	Check if the required spaces for installation (specified in the installation manual) are provided.	—

2. Troubleshooting with LED

2.1 Indoor Unit

Operation Lamp

The operation lamp blinks when any of the following errors is detected.

1. When a protection device of the indoor or outdoor unit is activated, or when the thermistor malfunctions.
 2. When a signal transmission error occurs between the indoor and outdoor units.
- In either case, conduct the diagnostic procedure described in the following pages.

CTXG series

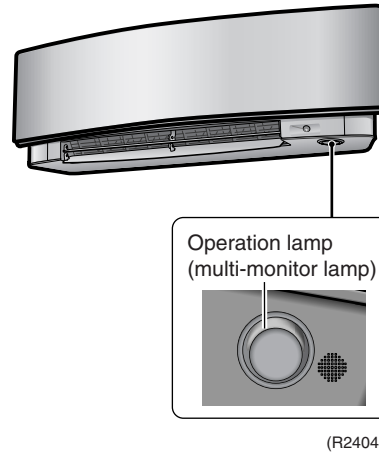

CTXS/FTXS series

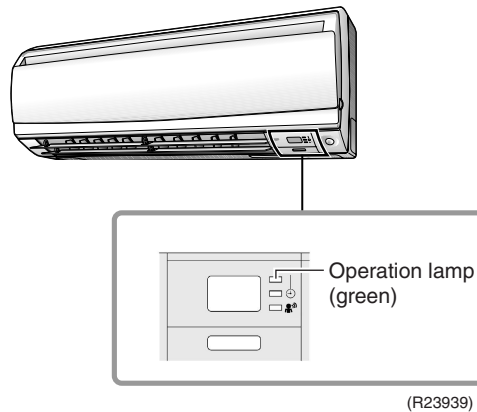

CDXS/FDXS series

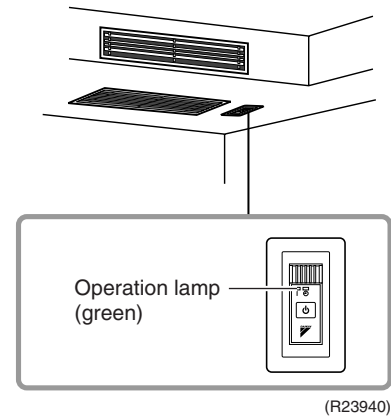

FVXS series

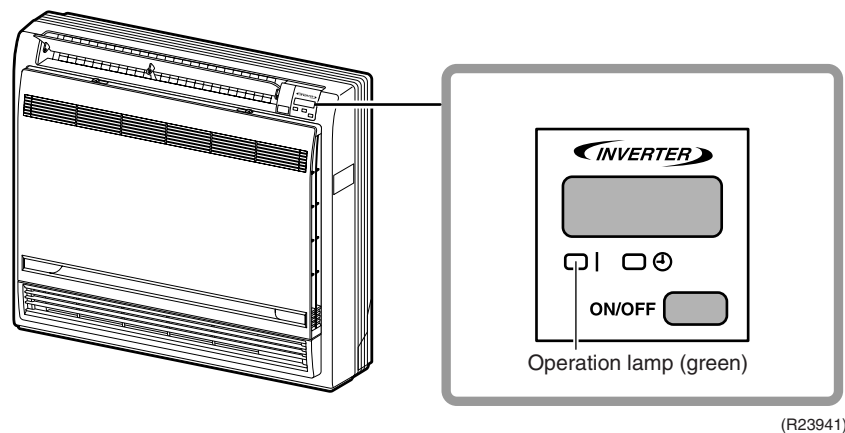

FFQ series with wired remote controller (BRC1E73)

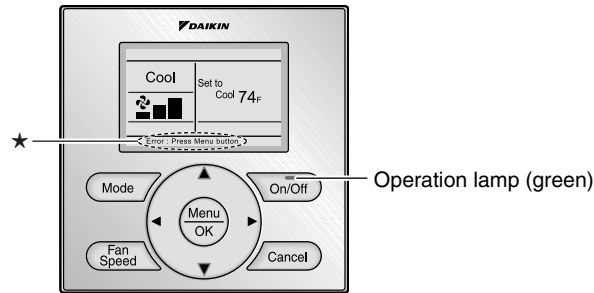

★The error or warning message also blinks on the basic screen. (R23942)

FFQ series with wireless remote controller kit (BRC082A41W, BRC082A42W(S))

In case of wireless remote controller, a transmitter board (A2P) and a receiver (A3P) are installed on indoor unit. When the error occurs, the operation lamp on the receiver (A3P) blinks.

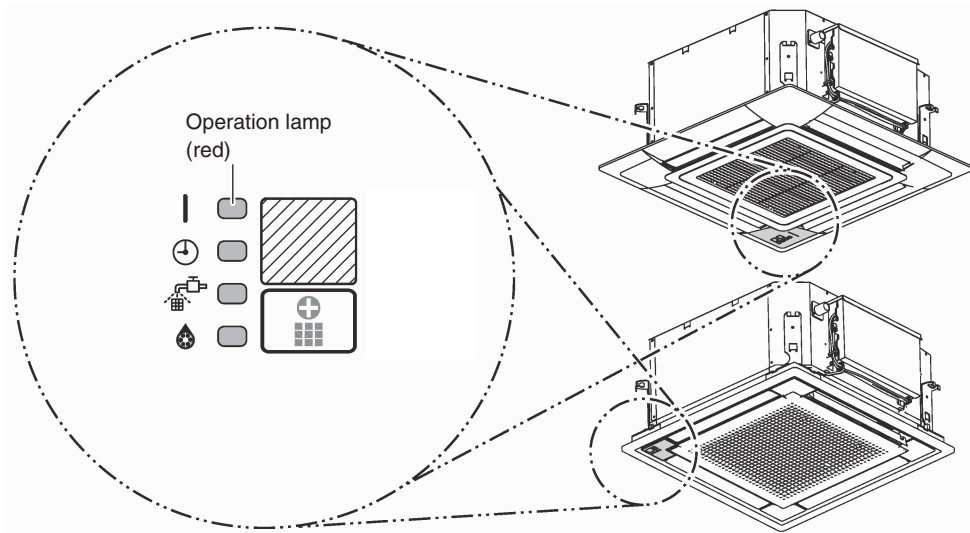

(R24044)



Caution:

When operation stops suddenly and the operation lamp blinks, it could be operation mode conflict. For FFQ models, even if the operation mode conflict occurs, the operation lamp does not blink.

- 1) Check if the operation modes all the same for the indoor units connected to multi system outdoor unit?
- 2) If not, set all the indoor units to the same operation mode and confirm that the operation lamp is not blinking.
- 3) Moreover, when the operation mode is automatic, set all the indoor unit operation mode as cooling or heating and check again if the operation lamp is normal.
If the lamp stops blinking after the above steps, there is no malfunction.

*Operation stops and operation lamp blinks only for the indoor unit that has a different operation mode set later. (The first set operation mode has priority.)

Service Monitor

The indoor unit has a green LED (LED A or HAP) on the control PCB. When the microcomputer works in order, the LED blinks. (Refer to pages 21, 23, 25, 27, 29, 31 for the location of LED.)

2.2 Outdoor Unit

The outdoor unit has a green LED (LED A) and red LEDs (LED 1 ~ LED 5) on the PCB.
When the microcomputer works in order, the LED A blinks, and when the system is in normal condition, the red LEDs are OFF.

Even after the error is canceled and the unit operates in normal condition, the LED indication remains.

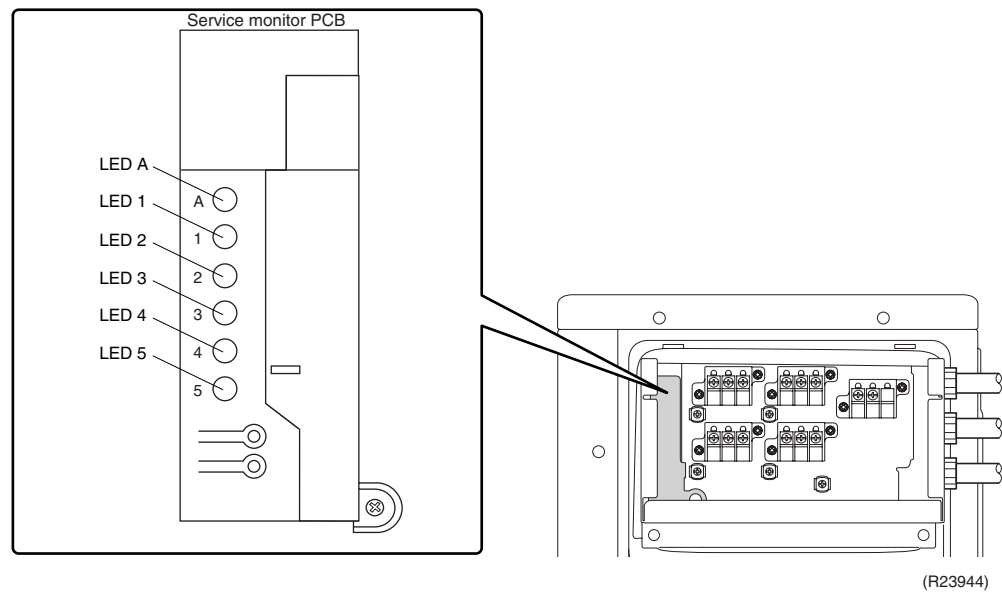

3. Service Diagnosis

3.1 CTXG, CTXS, FTXS, CDXS, FDXS, FVXS Series

3.1.1 ARC452 Series Remote Controller

Method 1

1. When **TIMER CANCEL** button is held down for 5 seconds,  is displayed on the temperature display screen.

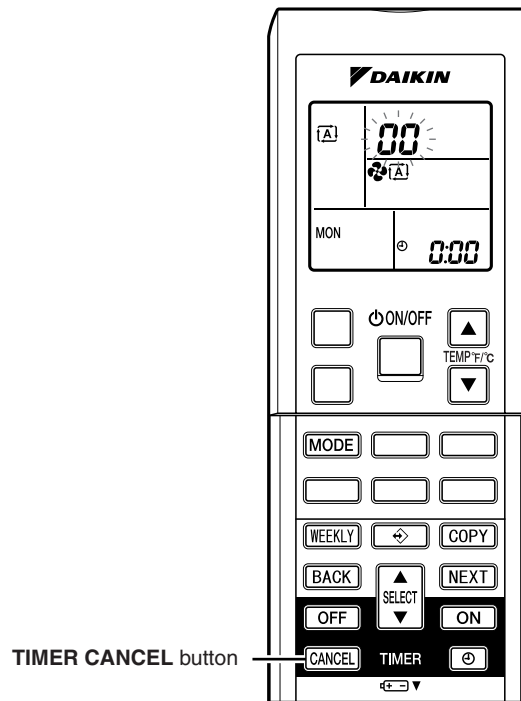

< ARC452 Series >

(R23945)

2. Press **TIMER CANCEL** button repeatedly until a long beep sounds.

■ The code indication changes in the sequence shown below.

ARC452A9, A21, A23

No.	Code	No.	Code	No.	Code
1	00	13	E7	25	UR
2	U4	14	R3	26	UH
3	L5	15	H8	27	P4
4	E6	16	H9	28	L3
5	H6	17	E9	29	L4
6	H0	18	E4	30	H7
7	R6	19	E5	31	U2
8	E7	20	J3	32	ER
9	U0	21	J6	33	RR
10	F3	22	E5	34	FR
11	R5	23	R1	35	H1
12	F6	24	E1	36	P9



Notes:

1. A short beep or two consecutive beeps indicate non-corresponding codes.
2. To return to the normal mode, hold down **TIMER CANCEL** button for 5 seconds. When the remote controller is left untouched for 60 seconds, it also returns to the normal mode.
3. Not all the error codes are displayed. When you cannot find the error code, try method 2. (→ Refer to page 123.)

Method 2

1. Press the 3 buttons (**TEMP▲**, **TEMP▼**, **MODE**) at the same time to enter the diagnosis mode.

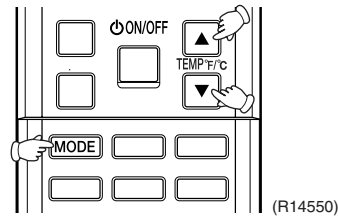

The left-side number blinks.

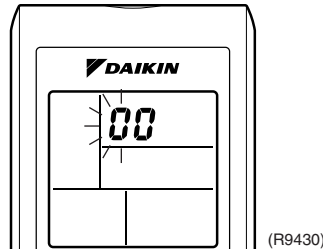

2. Press **TEMP ▲** or **TEMP ▼** button and change the number until you hear the two consecutive beeps or the long beep.

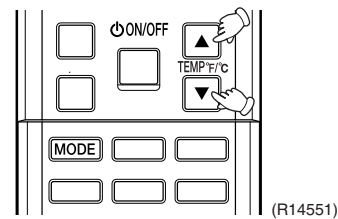

3. Diagnose by the sound.
 - ★beep : The left-side number does not correspond with the error code.
 - ★two consecutive beeps : The left-side number corresponds with the error code but the right-side number does not.
 - ★long beep : Both the left-side and right-side number correspond with the error code. The numbers indicated when you hear the long beep are the error code. Refer to page 134, 135.

4. Press **MODE** button.

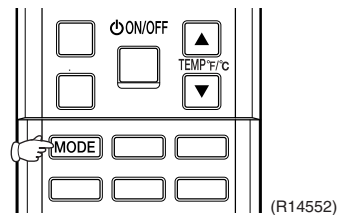

The right-side number blinks.

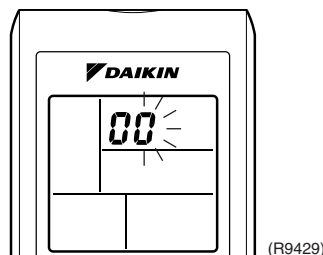

5. Press **TEMP ▲** or **TEMP ▼** button and change the number until you hear the long beep.

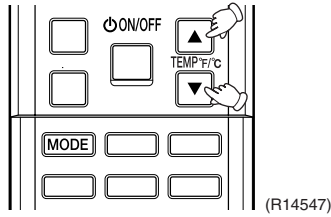

6. Diagnose by the sound.
- ★beep : The left-side number does not correspond with the error code.
 - ★two consecutive beeps : The left-side number corresponds with the error code but the right-side number does not.
 - ★long beep : Both the left-side and right-side number corresponds with the error code.
7. Determine the error code.
The numbers indicated when you hear the long beep are the error code.
Refer to page 134, 135.

8. Press **MODE** button to exit from the diagnosis mode.

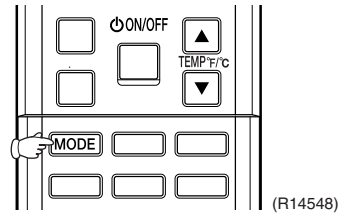

The display **7-** means the trial operation mode.
Refer to page 207 for trial operation.

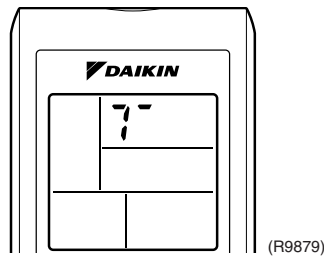

9. Press **ON/OFF** button twice to return to the normal mode.

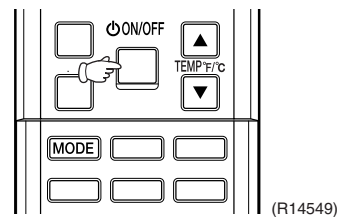

Note: When the remote controller is left untouched for 60 seconds, it returns to the normal mode.

3.1.2 ARC466 Series Remote Controller

Method 1

1. When **Timer Cancel** button is held down for 5 seconds, **00** is displayed on the temperature display screen.

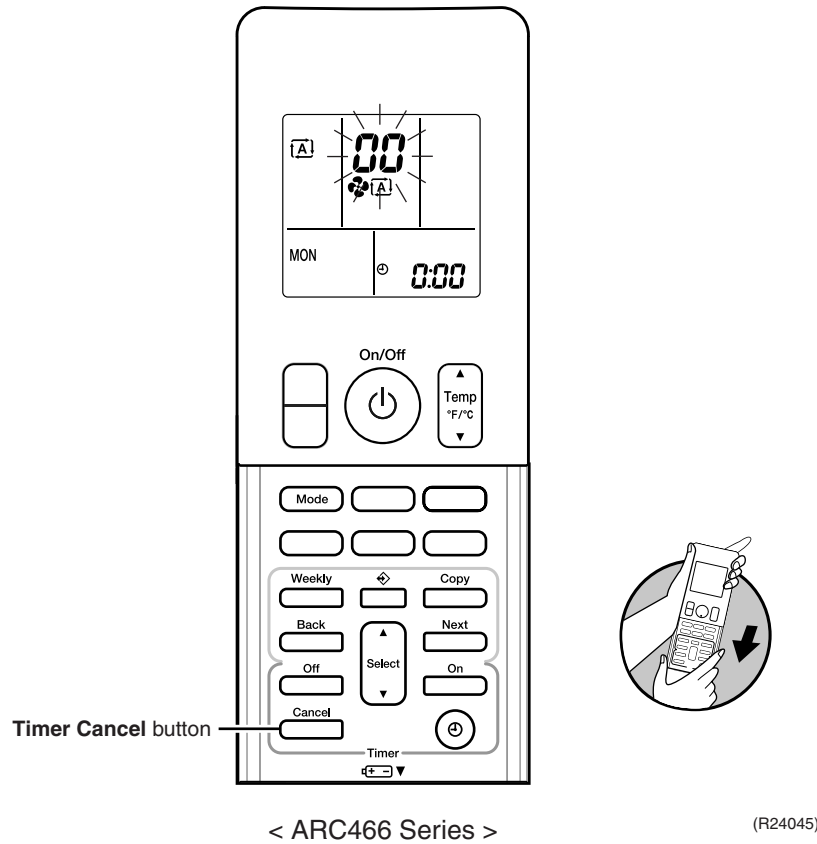

2. Press **Timer Cancel** button repeatedly until a long beep sounds.

■ The code indication changes in the sequence shown below.

ARC466A21, A36

No.	Code	No.	Code	No.	Code
1	00	14	U0	27	UR
2	R5	15	E7	28	UH
3	E7	16	R3	29	P4
4	F3	17	H8	30	H7
5	F6	18	H9	31	U2
6	L3	19	E9	32	ER
7	L4	20	E4	33	RH
8	L5	21	E5	34	FR
9	U4	22	J3	35	H1
10	E6	23	J6	36	P9
11	H6	24	E5	37	E3
12	H0	25	R1	38	H3
13	R6	26	E1		



Notes:

1. A short beep or two consecutive beeps indicate non-corresponding codes.
2. To return to the normal mode, hold down **Timer Cancel** button for 5 seconds. When the remote controller is left untouched for 60 seconds, it also returns to the normal mode.
3. Not all the error codes are displayed. When you cannot find the error code, try method 2. (→ Refer to page 126.)

Method 2

1. Press the center of **Temp** button and **Mode** button at the same time.

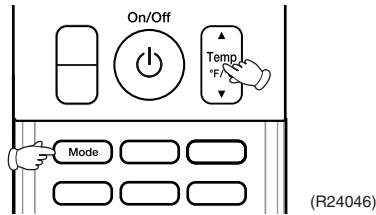

5C is displayed on the LCD.

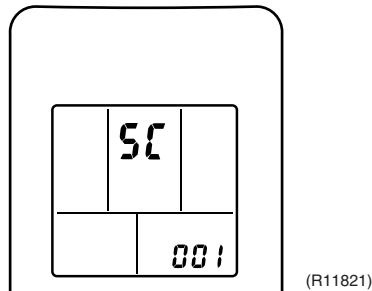

2. Select 5C (service check) with **Temp ▲** or **Temp ▼** button.
3. Press **Mode** button to enter the service check mode.

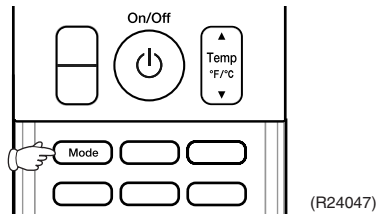

The left-side number blinks.

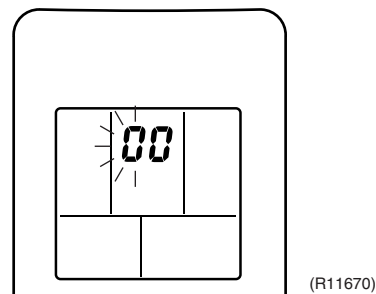

4. Press **Temp ▲** or **Temp ▼** button and change the number until you hear the two consecutive beeps or the long beep.

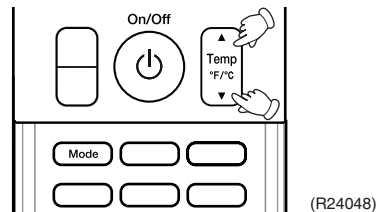

5. Diagnose by the sound.
 - ★ beep: The left-side number does not correspond with the error code.
 - ★ two consecutive beeps: The left-side number corresponds with the error code but the right-side number does not.
 - ★ long beep: Both the left-side and right-side numbers correspond with the error code.
The numbers indicated when you hear the long beep are the error code.
Refer to page 134, 135.

6. Press **Mode** button.

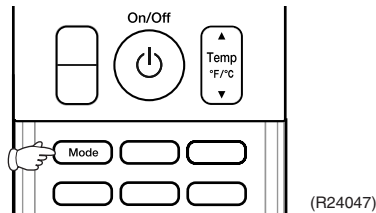

The right-side number blinks.

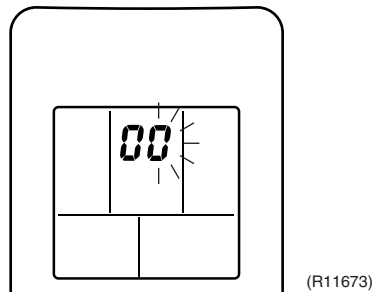

7. Press **Temp ▲** or **Temp ▼** button and change the number until you hear the long beep.

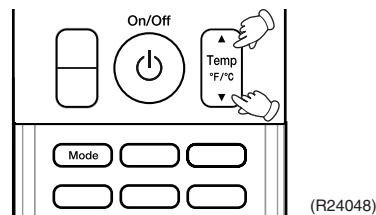

8. Diagnose by the sound.
 - ★ beep: The left-side number does not correspond with the error code.
 - ★ two consecutive beeps: The left-side number corresponds with the error code but the right-side number does not.
 - ★ long beep: Both the left-side and right-side numbers correspond with the error code.

9. Determine the error code.
The numbers indicated when you hear the long beep are the error code.
Refer to page 134, 135.

10. Press **Mode** button for 5 seconds to exit from the service check mode.
(When the remote controller is left untouched for 60 seconds, it returns to the normal mode also.)

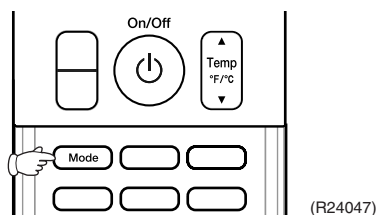

3.2 FFQ Series

3.2.1 Wired Remote Controller (BRC1E73)

Relations Between Modes

On power-up, the message “Checking the connection. Please standby.” will be displayed on the remote controller screen temporarily and then the basic screen will be displayed. To access a mode from the basic screen, refer to the figure below.

When any of the operation buttons is pressed, the backlight will come on and remain lit for about 30 seconds. Be sure to press a button while the backlight is on.

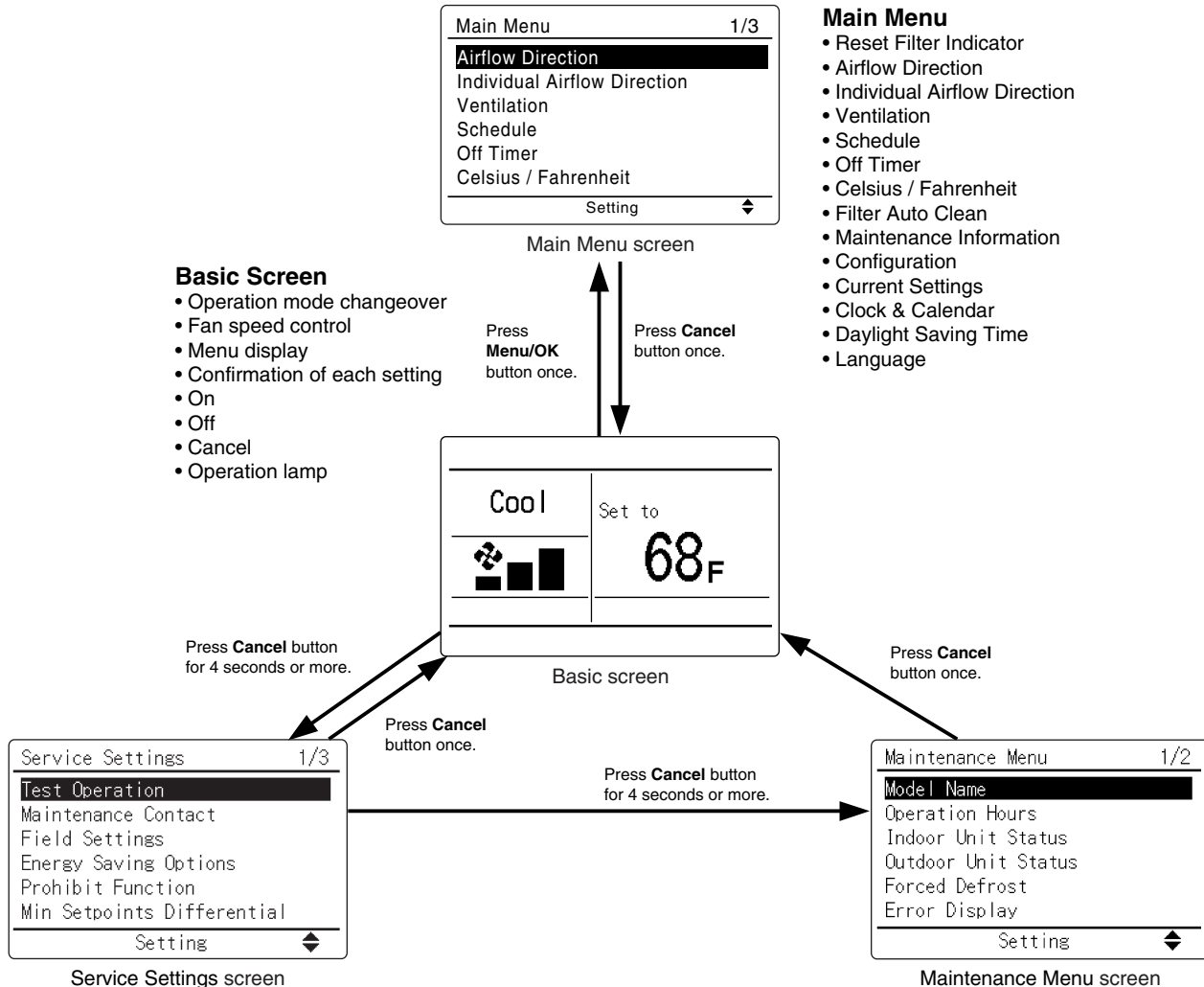

- Basic Screen**
- Operation mode changeover
 - Fan speed control
 - Menu display
 - Confirmation of each setting
 - On
 - Off
 - Cancel
 - Operation lamp

- Main Menu**
- Reset Filter Indicator
 - Airflow Direction
 - Individual Airflow Direction
 - Ventilation
 - Schedule
 - Off Timer
 - Celsius / Fahrenheit
 - Filter Auto Clean
 - Maintenance Information
 - Configuration
 - Current Settings
 - Clock & Calendar
 - Daylight Saving Time
 - Language

- Service Settings**
- Test Operation
 - Maintenance Contact
 - Field Settings
 - Energy Saving Options
 - Prohibit Function
 - Min Setpoints Differential
 - Group Address
 - Indoor unit AirNet Address
 - Outdoor unit AirNet Address
 - Error History
 - Indoor Unit Status
 - Outdoor Unit Status
 - Forced Fan ON
 - Switch Main Sub Controller
 - Filter Indicator
 - Test Filter Auto Clean
 - Brush / Filter Ind.
 - Disable Filter Auto Clean

- Maintenance Menu**
- Model Name
 - Operation Hours
 - Indoor Unit Status
 - Outdoor Unit Status
 - Forced Defrost
 - Error Display
 - Swap Unit No.
 - Addressed Sensor Value

★ The items shown on the remote controller are different depending on the connected indoor unit.

(R24620)

Service Diagnosis

The following message is displayed on the screen when an error (or a warning) occurs during operation.

Check the error code and take the corrective action specified for the particular model.

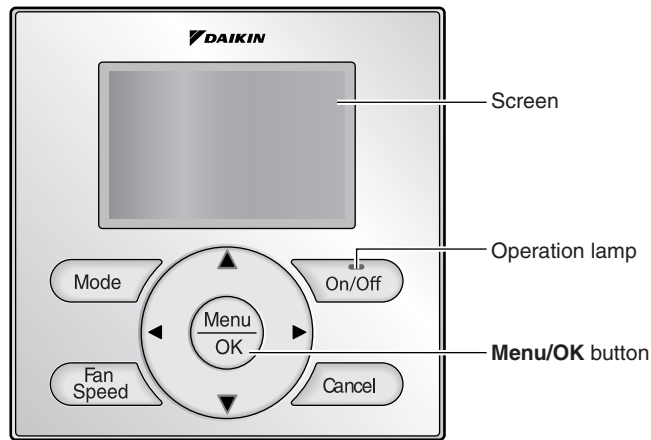

(R18817)

Operation

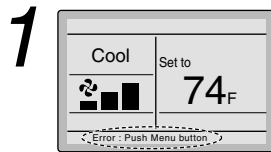

- If an error occurs, either one of the following items will flash in the basic screen.

Error: Push Menu button

- * The Operation lamp will flash.
- * For Simple display, the message is not displayed, and only the Operation lamp flashes.

Warning: Push Menu button

- * The Operation lamp will not flash.
- * For Simple display, the message is not displayed, and the Operation lamp does not flash, either.

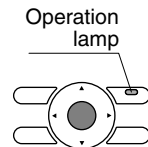

- Press **Menu/OK** button.

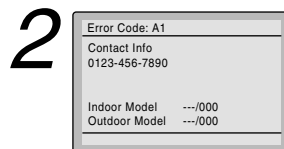

- The error code will flash and the service contact and model name or code may be displayed.
- Notify your Daikin dealer of the Error code and model name or code.

3.2.2 Wireless Remote Controller Kit (BRC082A41W, BRC082A42W(S))

Relations Between Modes The following modes can be selected by using **INSPECTION/TEST OPERATION** button on the remote controller.

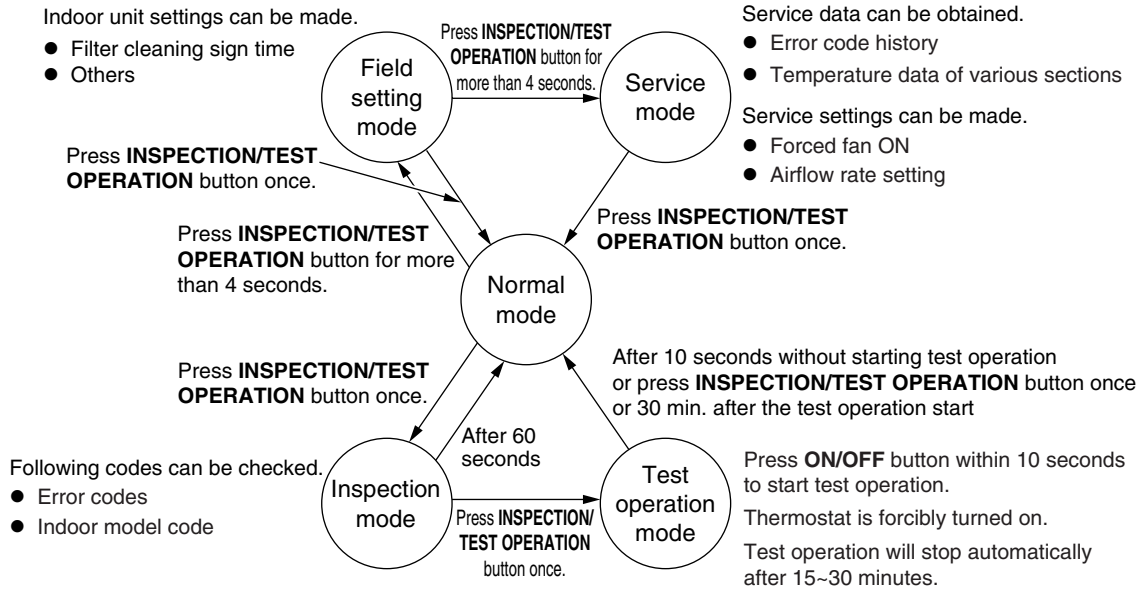

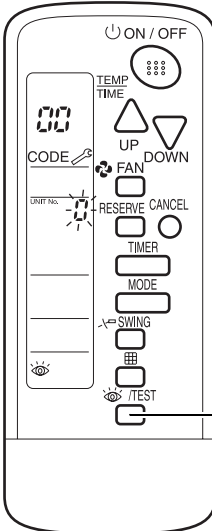

Service Diagnosis

To find the error code, proceed as follows:

Step	Action
1	<p>Press INSPECTION/TEST OPERATION button to enter the inspection mode. Then the figure  blinks on the UNIT No. display.</p>  <p>INSPECTION/TEST OPERATION button</p>

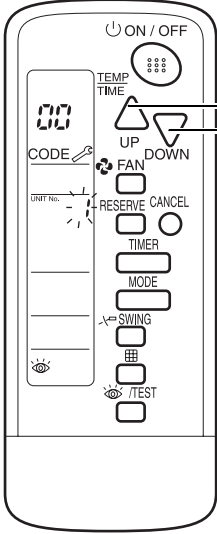
(R24050)

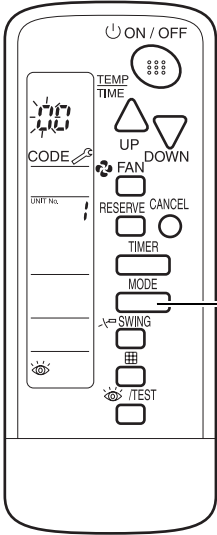
Step	Action								
<p data-bbox="451 240 472 268">2</p>	<p data-bbox="540 240 1482 268">Press UP or DOWN button and change the UNIT No. until the indoor unit starts to beep.</p> <div data-bbox="743 289 1268 825">  <p data-bbox="1065 385 1268 434">UP button DOWN button</p> </div> <p data-bbox="1198 810 1268 832">(R15408)</p> <table border="1" data-bbox="631 902 1390 1144"> <thead> <tr> <th data-bbox="631 902 1010 938">If you hear...</th> <th data-bbox="1010 902 1390 938">Then...</th> </tr> </thead> <tbody> <tr> <td data-bbox="631 938 1010 974">3 short beeps</td> <td data-bbox="1010 938 1390 974">Follow all steps below.</td> </tr> <tr> <td data-bbox="631 974 1010 1108">1 short beep</td> <td data-bbox="1010 974 1390 1108">Follow steps 3 and 4. Continue the operation in step 4 until you hear a long beep. This long beep indicates that the error code is confirmed.</td> </tr> <tr> <td data-bbox="631 1108 1010 1144">1 long beep</td> <td data-bbox="1010 1108 1390 1144">There is no abnormality.</td> </tr> </tbody> </table>	If you hear...	Then...	3 short beeps	Follow all steps below.	1 short beep	Follow steps 3 and 4. Continue the operation in step 4 until you hear a long beep. This long beep indicates that the error code is confirmed.	1 long beep	There is no abnormality.
If you hear...	Then...								
3 short beeps	Follow all steps below.								
1 short beep	Follow steps 3 and 4. Continue the operation in step 4 until you hear a long beep. This long beep indicates that the error code is confirmed.								
1 long beep	There is no abnormality.								
<p data-bbox="451 1176 472 1204">3</p>	<p data-bbox="540 1176 1482 1225">Press OPERATION MODE SELECTOR button. The left  (upper digit) indication of the error code blinks.</p> <div data-bbox="735 1247 1284 1783">  <p data-bbox="1084 1538 1284 1587">OPERATION MODE SELECTOR button</p> </div> <p data-bbox="1222 1772 1292 1793">(R24051)</p>								

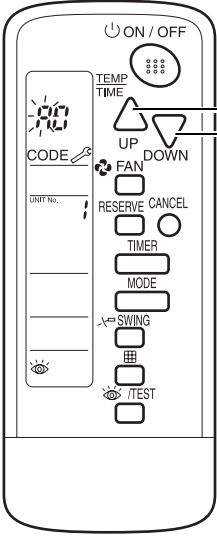
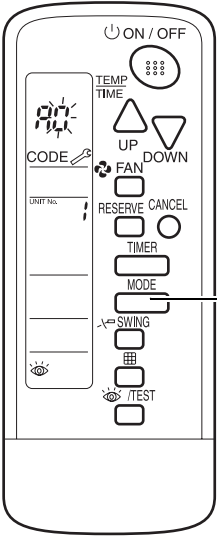
Step	Action								
4	<p>Press UP or DOWN button to change the error code upper digit until the indoor unit beeps.</p> <div style="display: flex; align-items: center;"> <div style="margin-right: 20px;"> <p>DOWN ▼</p> <p>4</p> <p>5</p> <p>6</p> <p>7</p> <p>8</p> <p>9</p> <p>0</p> <p>UP ▲</p> </div> <div style="text-align: center;">  <p>UP button DOWN button</p> </div> </div> <p style="text-align: right;">(R15411)</p> <table border="1" style="width: 100%; margin-top: 20px;"> <thead> <tr> <th data-bbox="631 906 1008 938">If you hear...</th> <th data-bbox="1008 906 1388 938">Then...</th> </tr> </thead> <tbody> <tr> <td data-bbox="631 938 1008 974">2 short beeps</td> <td data-bbox="1008 938 1388 974">The upper digit matches.</td> </tr> <tr> <td data-bbox="631 974 1008 1010">1 short beep</td> <td data-bbox="1008 974 1388 1010">No digits match.</td> </tr> <tr> <td data-bbox="631 1010 1008 1046">1 long beep</td> <td data-bbox="1008 1010 1388 1046">Both upper and lower digits match.</td> </tr> </tbody> </table>	If you hear...	Then...	2 short beeps	The upper digit matches.	1 short beep	No digits match.	1 long beep	Both upper and lower digits match.
If you hear...	Then...								
2 short beeps	The upper digit matches.								
1 short beep	No digits match.								
1 long beep	Both upper and lower digits match.								
5	<p>Press OPERATION MODE SELECTOR button. The right 3 (lower digit) indication of the error code blinks.</p> <div style="text-align: center;">  <p>OPERATION MODE SELECTOR button</p> </div> <p style="text-align: right;">(R24052)</p>								

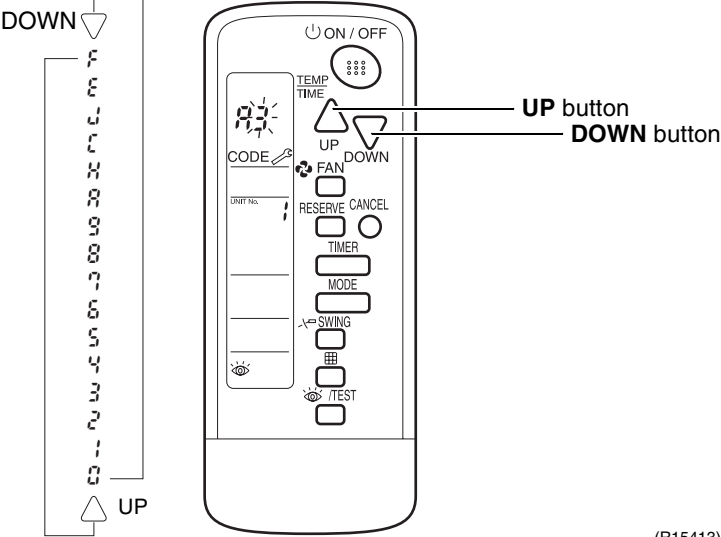
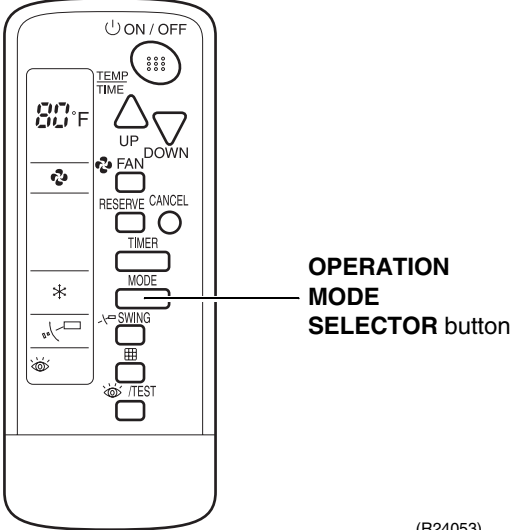
Step	Action						
<p>6</p>	<p>Press UP or DOWN button and change the error code lower digit until the indoor unit generates long beep.</p>  <p>(R15413)</p> <table border="1" data-bbox="631 910 1390 1017"> <thead> <tr> <th>If you hear...</th> <th>Then...</th> </tr> </thead> <tbody> <tr> <td>2 short beeps</td> <td>No digits match.</td> </tr> <tr> <td>1 long beep</td> <td>Both upper and lower digits match.</td> </tr> </tbody> </table>	If you hear...	Then...	2 short beeps	No digits match.	1 long beep	Both upper and lower digits match.
If you hear...	Then...						
2 short beeps	No digits match.						
1 long beep	Both upper and lower digits match.						
<p>7</p>	<p>Press OPERATION MODE SELECTOR button to return to the normal mode. If you do not press any button for 1 minute, the remote controller automatically returns to the normal mode.</p>  <p>(R24053)</p>						

4. Code Indication on Remote Controller

4.1 CTXG, CTXS, FTXS, CDXS, FDXS, FVXS Series

Error Codes	Description	Reference Page	
00	Normal condition	—	
R1	Indoor unit PCB abnormality	136	
RS	Freeze-up protection control/heating peak-cut control	138	
R6	Indoor fan motor or related abnormality	DC motor (CTXG, CTXS, FTXS, FVXS series)	139
		AC motor (CDXS, FDXS series)	141
C4	Indoor heat exchanger thermistor or related abnormality	143	
C7	Front panel open/close fault (CTXG series only)	144	
C9	Room temperature thermistor or related abnormality	143	
U4	Signal transmission error (between indoor unit and outdoor unit)	145	
UR	Mismatching of indoor unit and outdoor unit	147	

4.2 FFQ Series

Error Codes	Description	Reference Page
00	Normal condition	—
R1	Indoor unit PCB abnormality	148
R3	Drain level control system abnormality	149
R6	Indoor fan motor (DC motor) or related abnormality (See the Note below.)	150
RF	Humidifier or Related abnormality	152
C4	Indoor heat exchanger thermistor 1 or related abnormality	153
C5	Indoor heat exchanger thermistor 2 or related abnormality	153
C9	Room temperature thermistor or related abnormality	153
CE	Presence sensor or floor sensor abnormality	154
CJ	Remote controller thermistor abnormality	155
U4	Signal transmission error (between indoor unit and outdoor unit)	156
U5	Signal transmission error (between indoor unit and remote controller)	158
U8	Signal transmission error (between MAIN remote controller and SUB remote controller)	159
UR	Mismatching of indoor unit and outdoor unit	160



Note: When there is a possibility of open phase power supply, also check power supply.

4.3 Outdoor Unit

☀: ON, ●: OFF, ⦿: Blinks

Outdoor Unit LED Indication						Error Codes	Description	Reference Page
Green	Red							
A	1	2	3	4	5			
⦿	●	●	●	●	●	00	Normal condition	—
						0A	Unspecified voltage (between indoor unit and outdoor unit)	166
						0H	Anti-icing control in other rooms	166
⦿	●	●	☀	☀	●	(0D)	Refrigerant shortage	161
⦿	☀	●	●	☀	●	0E	Low-voltage detection or over-voltage detection	163
⦿	●	☀	●	●	●	0F	Wiring Error Check Unexecuted	165
⦿	☀	●	☀	☀	●	0S	Anti-icing control for indoor unit	167
⦿	☀	☀	☀	●	●	E1	Outdoor unit PCB abnormality	169
⦿	☀	●	☀	●	●	(E5)	OL activation (compressor overload)	170
⦿	●	☀	☀	●	●	(E6)	Compressor lock	172
⦿	☀	☀	☀	☀	●	E7	DC fan lock	173
⦿	●	☀	●	☀	●	E8	Input overcurrent detection	174
⦿	☀	●	●	●	●	E9	Four way valve abnormality	175
⦿	☀	●	☀	●	●	F3	Discharge pipe temperature control	177
⦿	☀	●	☀	☀	●	F6	High pressure control in cooling	178
⦿	☀	☀	●	●	●	H0	Compressor sensor system abnormality	179
						H6	Position sensor abnormality	181
						H8	CT or related abnormality	183
						H9	Outdoor temperature thermistor or related abnormality	185
						J3	Discharge pipe thermistor or related abnormality	185
						J5	Outdoor heat exchanger thermistor or related abnormality	185
						J8	Liquid pipe thermistor or related abnormality	185
						J9	Gas pipe thermistor or related abnormality	185
						P4	Radiation fin thermistor or related abnormality	185
⦿	☀	☀	●	☀	●	L3	Electrical box temperature rise	187
⦿	●	●	●	☀	●	L4	Radiation fin temperature rise	188
⦿	●	●	☀	●	●	L5	Output overcurrent detection	189
☀	—	—	—	—	—	—	See the note 4.	—
●	—	—	—	—	—	—	Check the power supply.	—



Notes:

- The error codes in the parenthesis () are displayed only when the system is shut down.
- When a sensor error occurs, check the remote controller display to determine which sensor is malfunctioning.
If the remote controller does not indicate the error code, conduct the following procedure.
 - * Turn the power off and then on again. If the same LED indication appears again immediately after the power is turned on, the fault is in the thermistor.
 - * If the above condition does not result, the fault is in the CT.
- The indoor unit error code may take the precedence in the remote controller display.
- Turn the power off and then on again. If the same LED indication appears again, outdoor unit PCB is faulty. Replace the outdoor unit PCB.

5. Troubleshooting for CTXG, CTXS, FTXS, CDXS, FDXS, FVXS Series

5.1 Indoor Unit PCB Abnormality

Error Code	A1
Method of Error Detection	The system checks if the circuit works properly within the microcomputer of the indoor unit.
Error Decision Conditions	The system cannot set the internal settings.
Supposed Causes	<ul style="list-style-type: none"> ■ Wrong models interconnected ■ Defective indoor unit PCB ■ Disconnection of connector ■ Reduction of power supply voltage

Troubleshooting

Caution Be sure to turn off the power switch before connecting or disconnecting connectors, or parts may be damaged.

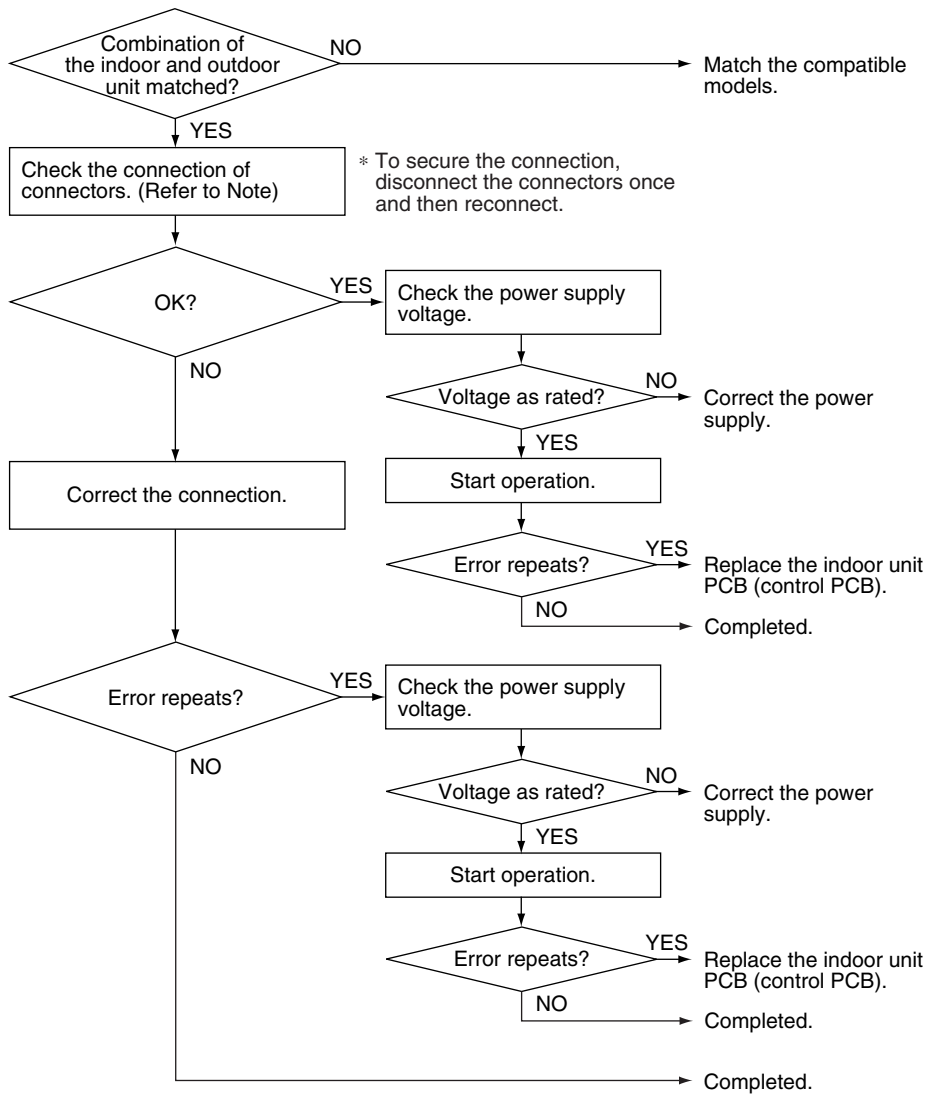

(R23407)

i Note: Check the following connector.

Model Type	Connector
CTXG, CTXS, FTXS, FVXS series	Terminal strip ~ Control PCB (H1, H2, H3)
CDXS, FDXS series	Terminal block ~ Control PCB (H1, H2, H3)

5.2 Freeze-up Protection Control/Heating Peak-cut Control

Error Code	A5
Method of Error Detection	<ul style="list-style-type: none"> ■ Freeze-up protection control During cooling operation, the freeze-up protection control (operation halt) is activated according to the temperature detected by the indoor heat exchanger thermistor. ■ Heating peak-cut control During heating operation, the temperature detected by the indoor heat exchanger thermistor is used for the heating peak-cut control (operation halt, outdoor fan stop, etc.)
Error Decision Conditions	<ul style="list-style-type: none"> ■ Freeze-up protection control During cooling operation, the indoor heat exchanger temperature is below 0°C (32°F). ■ Heating peak-cut control During heating operation, the indoor heat exchanger temperature is above 65°C (149°F).
Supposed Causes	<ul style="list-style-type: none"> ■ Short-circuited air ■ Clogged air filter of the indoor unit ■ Dust accumulation on the indoor heat exchanger ■ Defective indoor heat exchanger thermistor ■ Defective indoor unit PCB

Troubleshooting



Check No.01
Refer to P.191

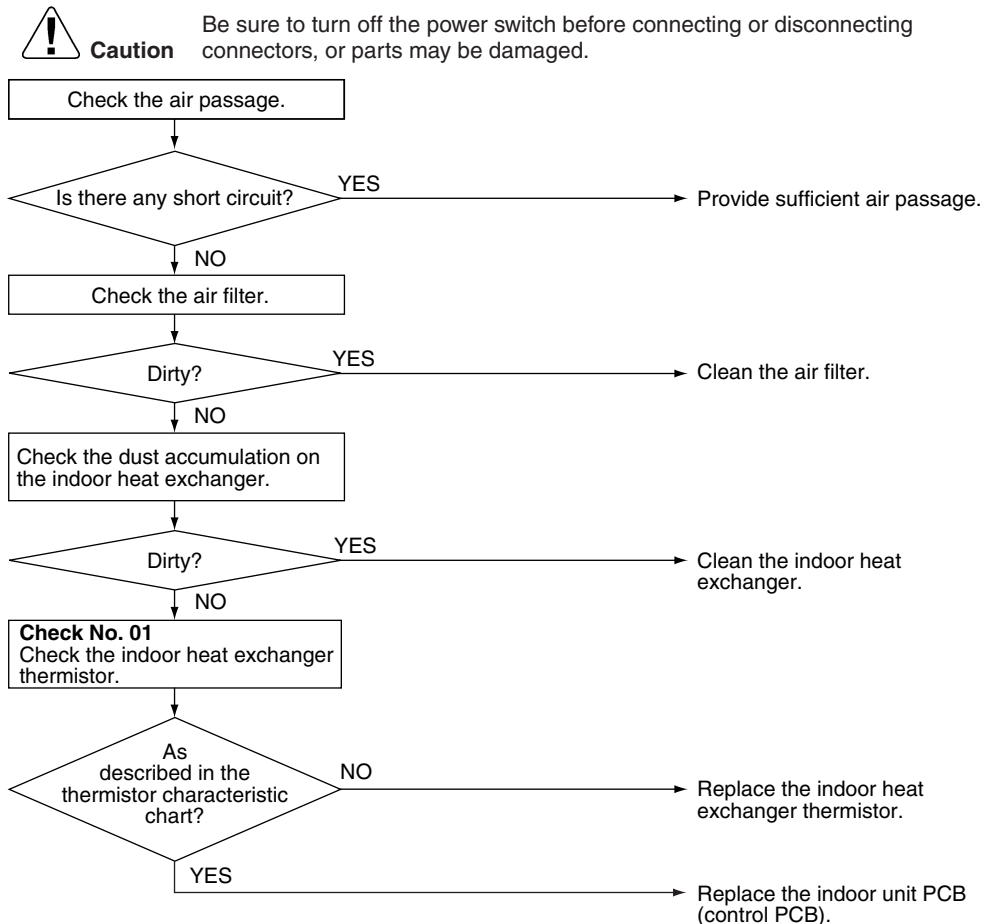

(R21064)

5.3 Indoor Fan Motor or Related Abnormality

5.3.1 Indoor Fan Motor (DC Motor) or Related Abnormality

Applicable Models	CTXG09/12/18QVJUW(S) CTXS07LVJU FTXS09/12/15/18/24LVJU FVXS09/12/15/18NVJU
Error Code	86
Method of Error Detection	The rotation speed detected by the Hall IC during indoor fan motor operation determines abnormal fan motor operation.
Error Decision Conditions	The detected rotation speed does not reach the demanded rotation speed of the target tap, and is less than 50% of the maximum fan motor rotation speed.
Supposed Causes	<ul style="list-style-type: none"> ■ Remarkable decrease in power supply voltage ■ Layer short inside the fan motor winding ■ Breaking of wire inside the fan motor ■ Breaking of the fan motor lead wires ■ Defective capacitor of the fan motor ■ Defective indoor unit PCB

Troubleshooting



Check No.02
Refer to P.192

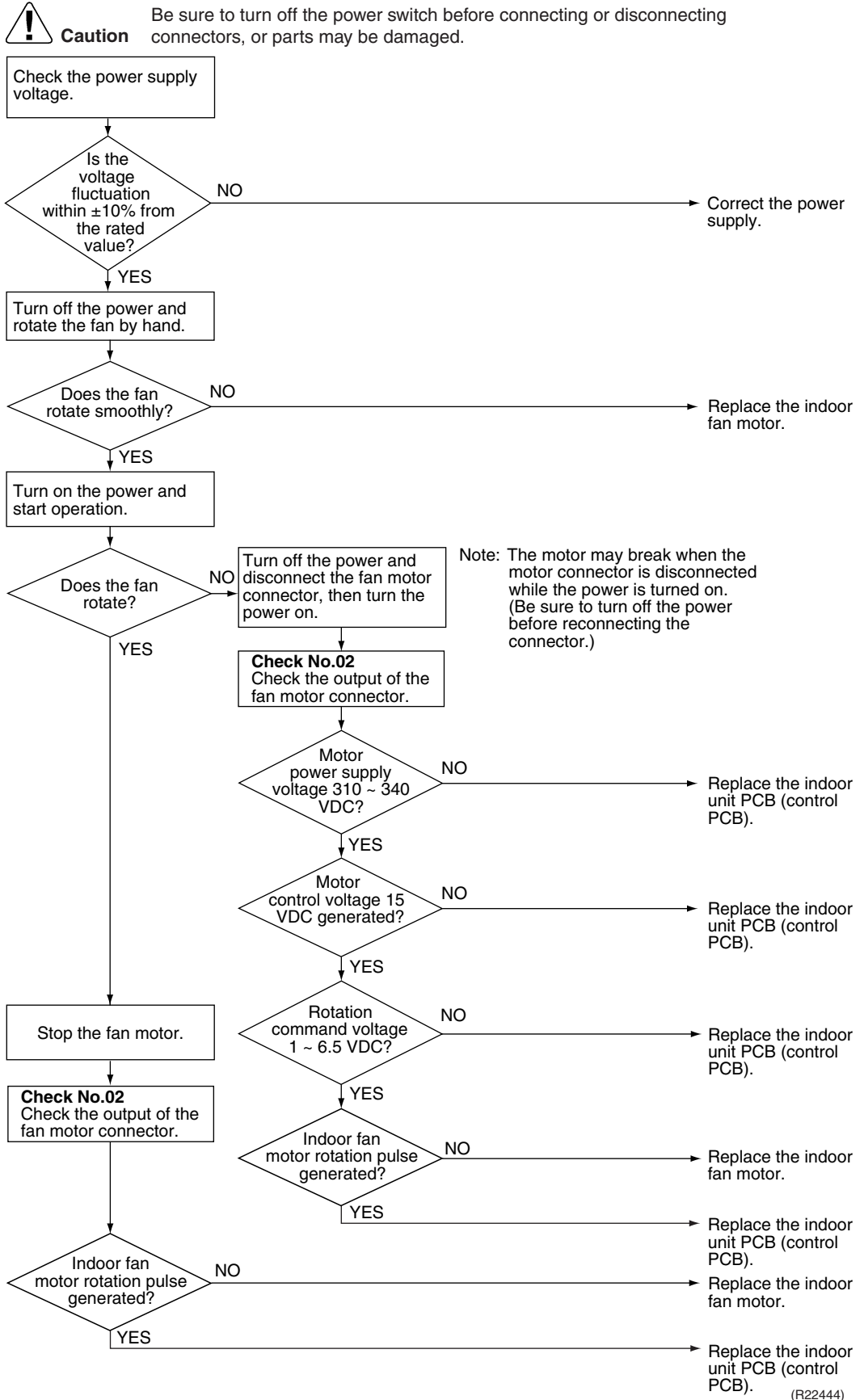

Note: The rotation pulse is the feedback signal from the indoor fan motor.

5.3.2 Indoor Fan Motor (AC Motor) or Related Abnormality

Applicable Models	FDXS09/12LVJU CDXS15/18/24LVJU
Error code	R6
Method of Error Detection	The rotation speed detected by the Hall IC during indoor fan motor operation determines abnormal fan motor operation.
Error Decision Conditions	The detected rotation speed does not reach the demanded rotation speed of the target tap.
Supposed Causes	<ul style="list-style-type: none">■ Power supply voltage out of specification■ Layer short inside the fan motor winding■ Breaking of wire inside the fan motor■ Breaking of the fan motor lead wires■ Defective capacitor of the fan motor■ Defective indoor unit PCB

Troubleshooting



Check No.04
Refer to P.192



Caution Be sure to turn off the power switch before connecting or disconnecting connectors, or parts may be damaged.

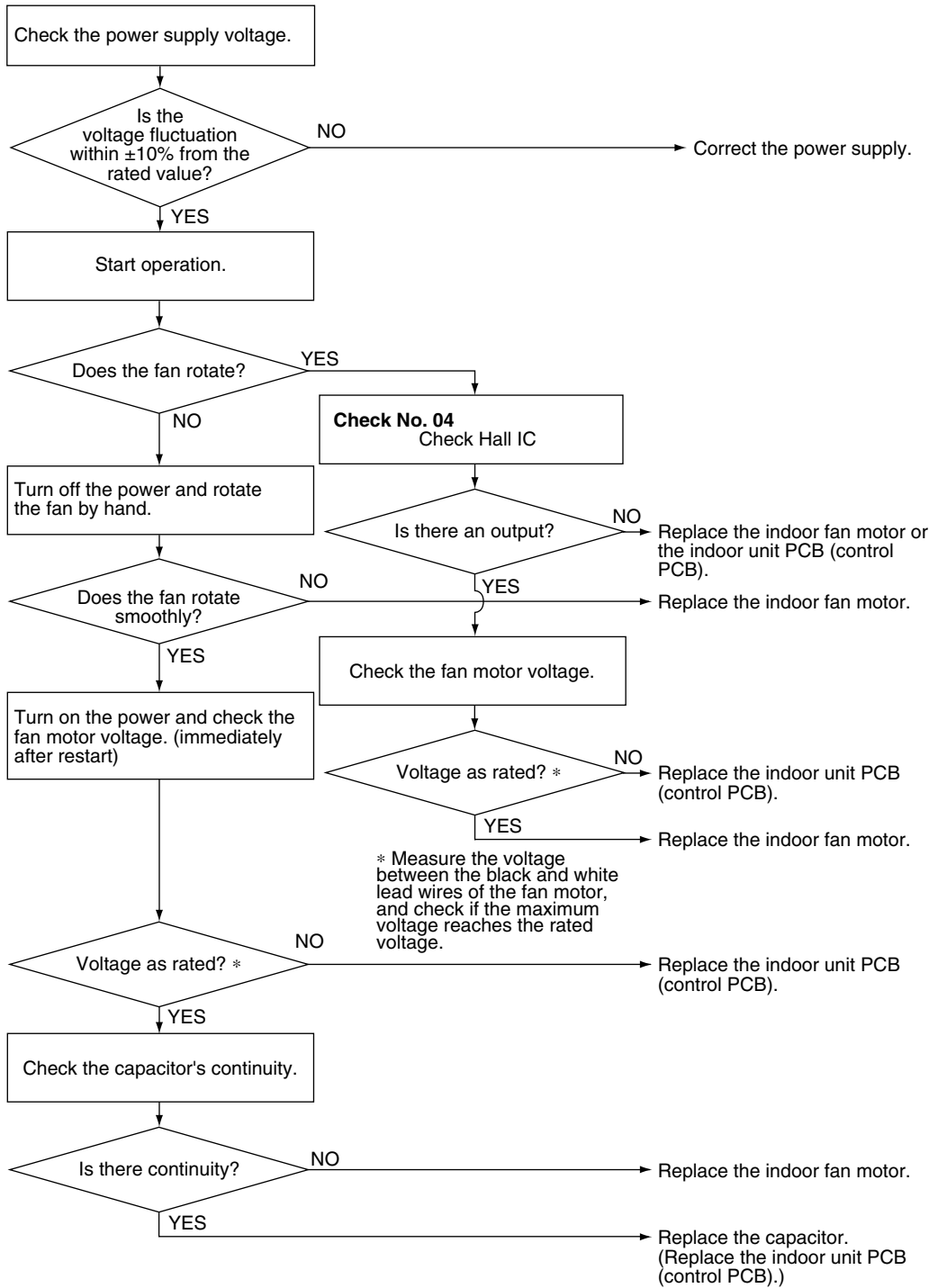

(R22267)

5.4 Thermistor or Related Abnormality

Error Code	Ⓞ4, Ⓞ9
Method of Error Detection	The temperatures detected by the thermistors determine thermistor errors.
Error Decision Conditions	The voltage between the both ends of the thermistor is either 4.96 V or more, or 0.04 V or less with the power on.
Supposed Causes	<ul style="list-style-type: none"> ■ Disconnection of connector ■ Thermistor corresponding to the error code is defective. ■ Defective indoor unit PCB

Troubleshooting

 **Check No.01**
Refer to P.191

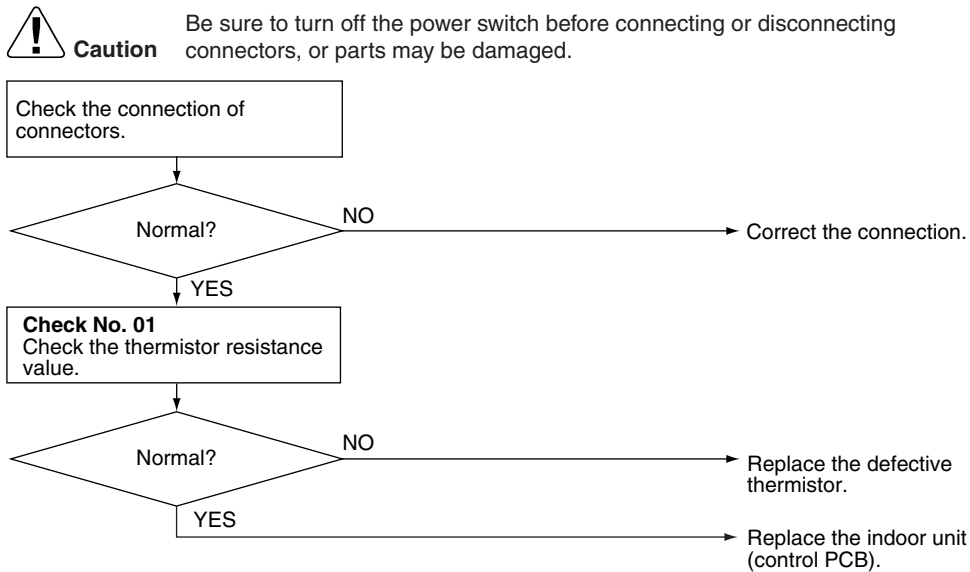

(R21870)

Ⓞ4 : Indoor heat exchanger thermistor
Ⓞ9 : Room temperature thermistor

 **Note:** When replacing the defective thermistor(s), replace the thermistors as ASSY.

5.5 Front Panel Open/Close Fault

Applicable Models	CTXG09/12/18QVJUW(S)
Error Code	
Error Decision Conditions	<ul style="list-style-type: none"> ■ If the error repeats, the system is shut down.
Supposed Causes	<ul style="list-style-type: none"> ■ Defective reduction motor ■ Malfunction or deterioration of the front panel mechanism ■ Defective limit switch

Troubleshooting

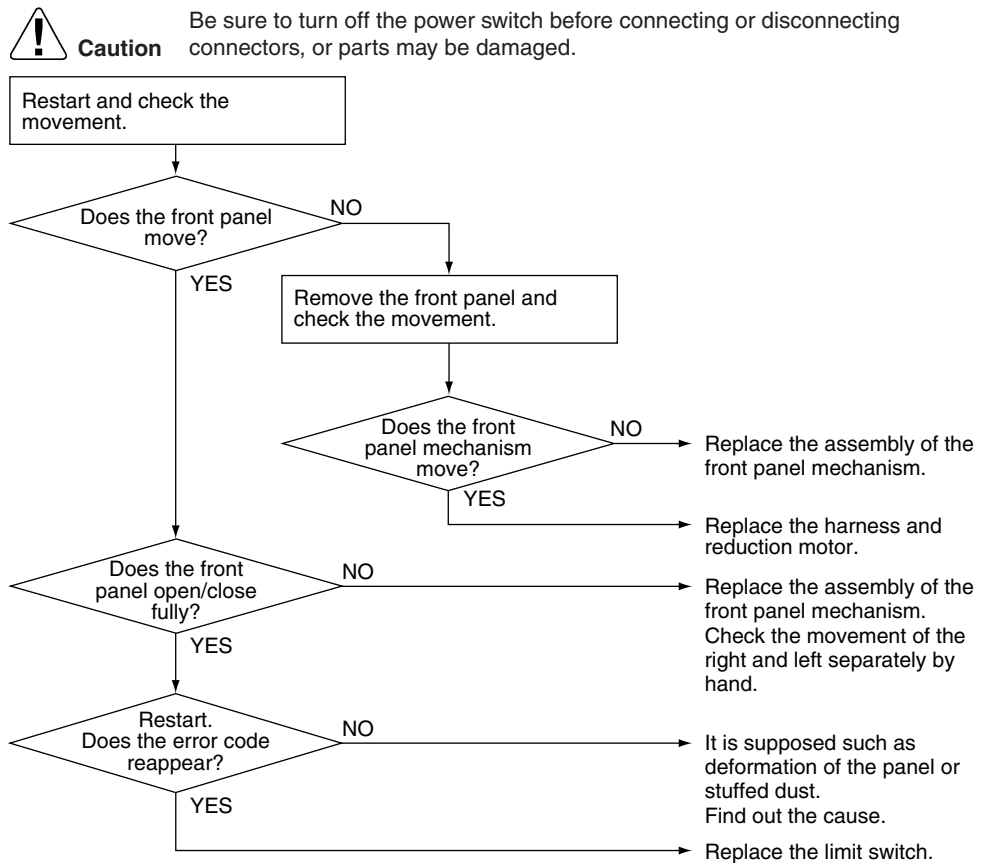

(R17249)



Note: You cannot operate the unit by the remote controller when the front panel mechanism breaks down.
 <To the dealers: temporary measure before repair>
 1. Turn off the power.
 2. Remove the front panel.
 3. Turn on the power.
 (Wait until the initialization finishes.)
 Operate the unit by the indoor unit **ON/OFF** button.

5.6 Signal Transmission Error (Between Indoor Unit and Outdoor Unit)

Error CodeU4

Method of Error Detection

The signal transmission data from the outdoor unit is checked whether it is normal.

Error Decision Conditions

The data sent from the outdoor unit cannot be received normally, or the content of the data is abnormal.

Supposed Causes

- Reduction of power supply voltage
- Wiring error
- Breaking of the connection wires between the indoor and outdoor units (wire No. 3)
- Defective outdoor unit PCB
- Short circuit inside the fan motor winding
- Defective indoor unit PCB
- Disturbed power supply waveform

Troubleshooting



Check No.11
Refer to P.193



Caution

Be sure to turn off the power switch before connecting or disconnecting connectors, or parts may be damaged.

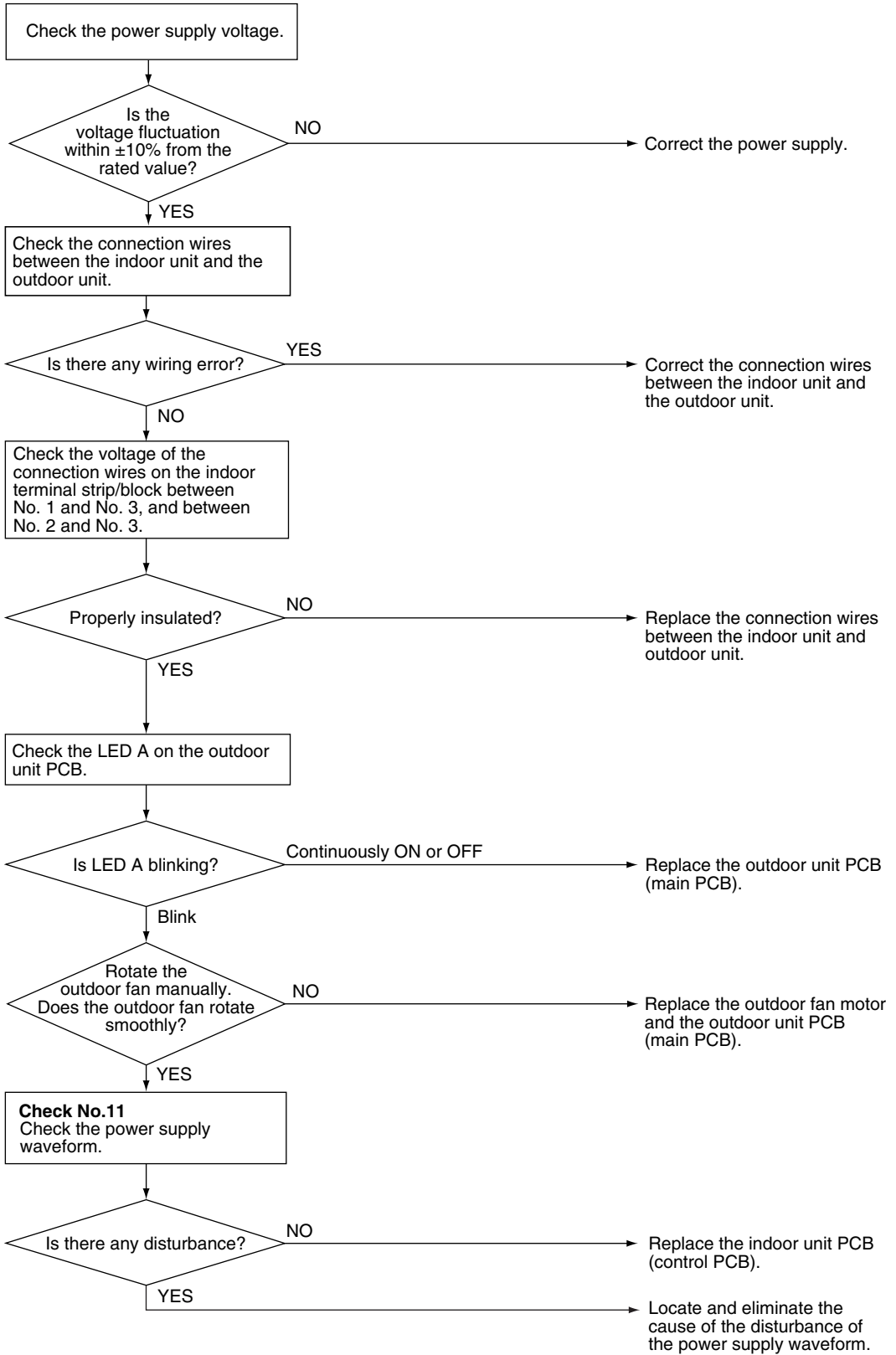

(R24621)

5.7 Mismatching of Indoor Unit and Outdoor Unit

Error Code



Method of Error Detection

The supply power is detected for its requirements (pair type is different from multi type) by the indoor/outdoor transmission signal.

Error Decision Conditions

The pair type and multi type are interconnected.

Supposed Causes

- Wrong models interconnected
- Wrong wiring of connecting wires
- Wrong indoor unit PCB or outdoor unit PCB mounted
- Defective indoor unit PCB
- Defective outdoor unit PCB

Troubleshooting



Caution

Be sure to turn off the power switch before connecting or disconnecting connectors, or parts may be damaged.

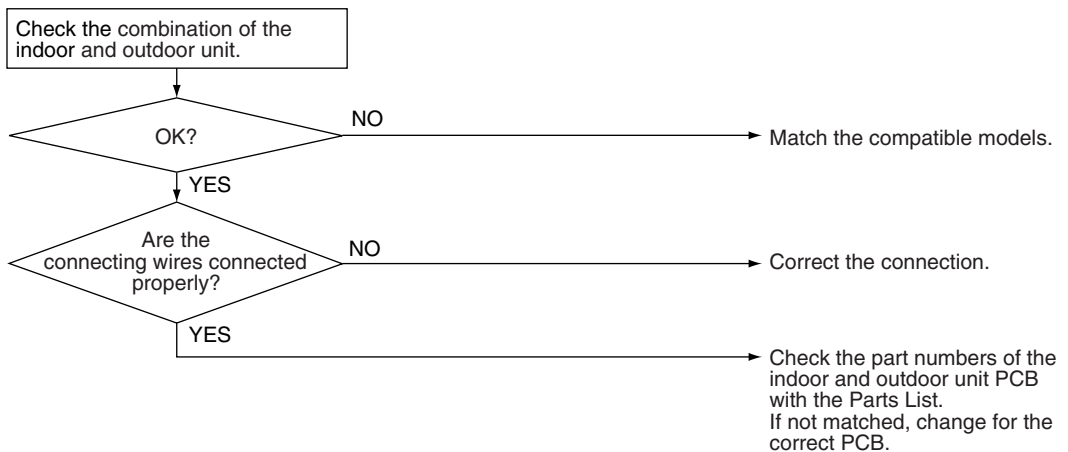

(R23001)

6. Troubleshooting for FFQ Series

6.1 Indoor Unit PCB Abnormality

Error Code	A1
Method of Error Detection	The system checks the data from EEPROM.
Error Decision Conditions	<p>The data from the EEPROM is not received correctly.</p> <p>EEPROM (Electrically Erasable Programmable Read Only Memory): A memory chip that holds its content without power. It can be erased, either within the computer or externally and usually requires more voltage for erasure than the common +5 volts used in logic circuits. It functions like non-volatile RAM, but writing to EEPROM is slower than writing to RAM.</p>
Supposed Causes	<ul style="list-style-type: none"> ■ Defective indoor unit PCB ■ External factor (noise etc.)

Troubleshooting

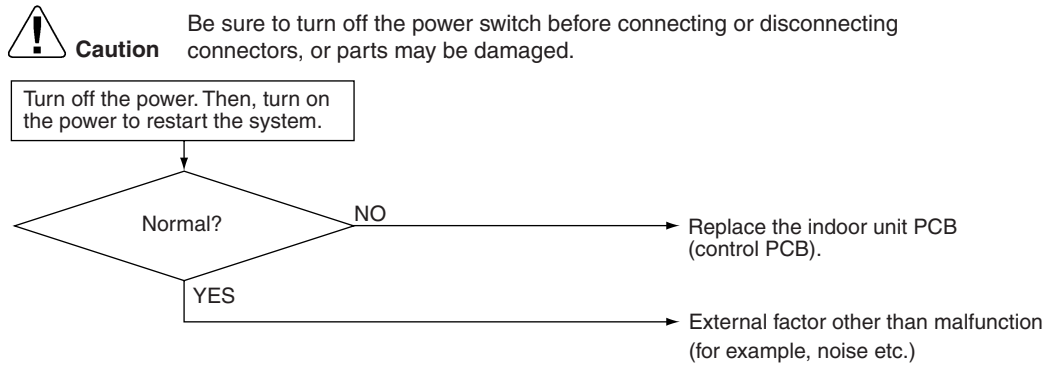

(R22247)

6.2 Drain Level Control System Abnormality

Error Code

R3

Method of Error Detection

The float switch detects error.

Error Decision Conditions

The water level reaches its upper limit and the float switch turns OFF.

Supposed Causes

- Defective drain pump
- Improper drain piping work
- Clogged drain piping
- Defective float switch
- Defective indoor unit PCB
- Defective connector X15A on indoor unit PCB

Troubleshooting

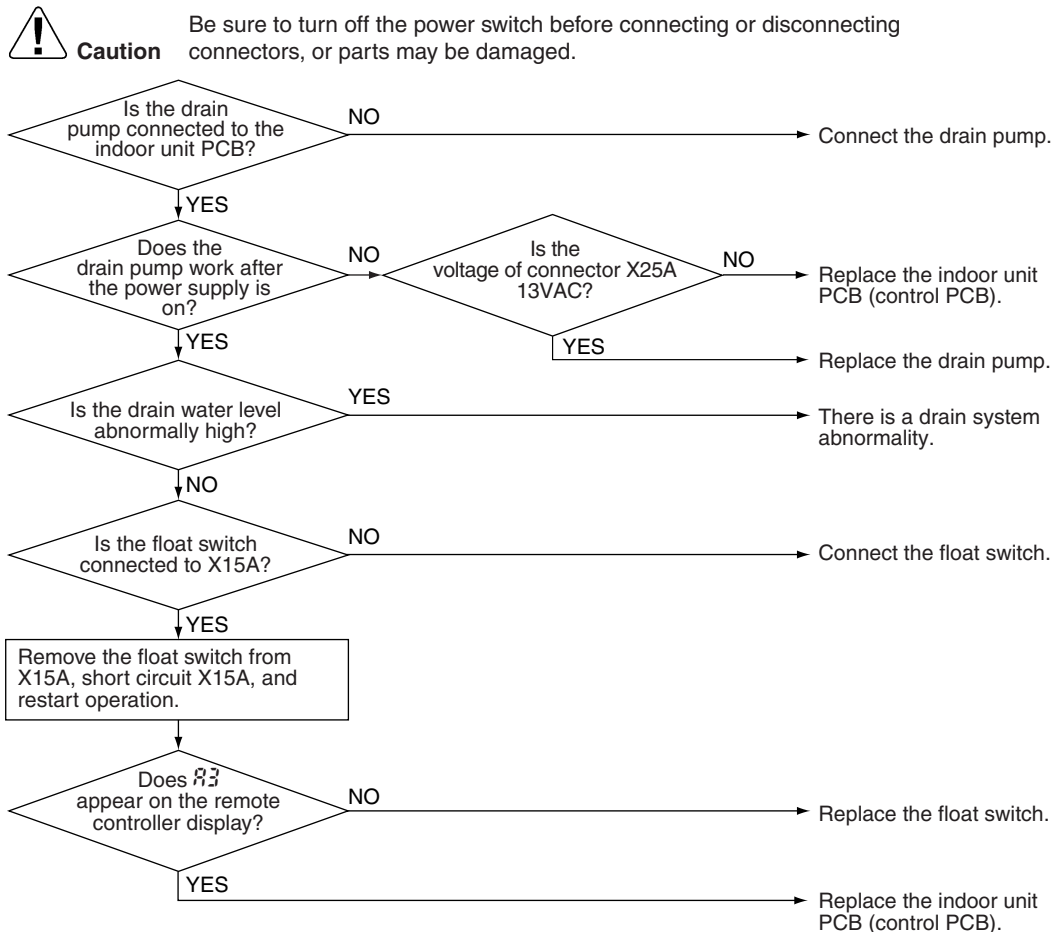

(R23963)

6.3 Indoor Fan Motor (DC Motor) or Related Abnormality

Error Code	R6
Method of Error Detection	The rotation speed detected by the Hall IC during indoor fan motor operation determines abnormal fan motor operation.
Error Decision Conditions	The fan motor is not revved up.
Supposed Causes	<ul style="list-style-type: none">■ Layer short inside the fan motor winding■ Breaking of wire inside the fan motor■ Breaking of the fan motor lead wires■ Defective indoor unit PCB

Troubleshooting



Check No.02
Refer to P.192

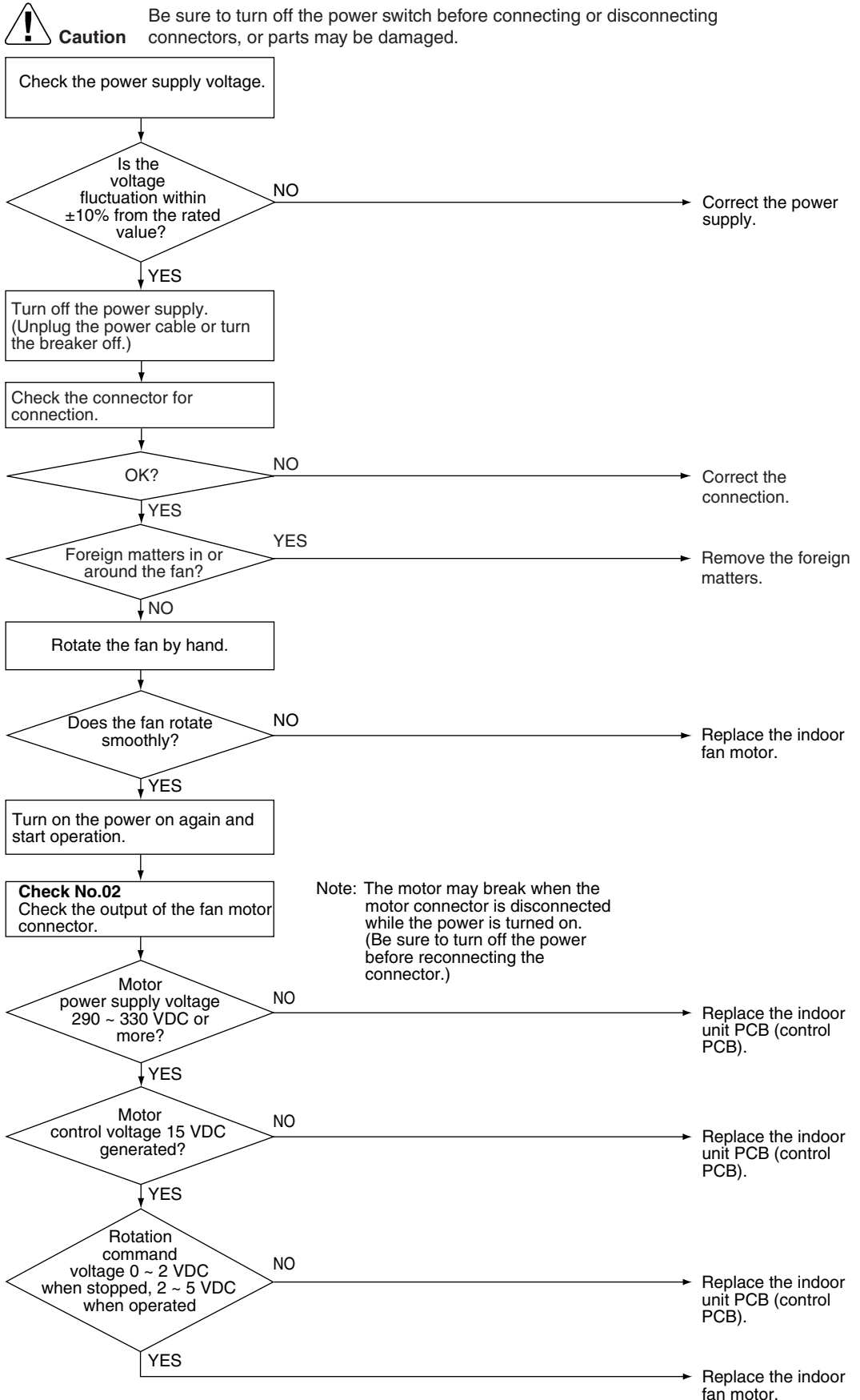

(R24054)

6.4 Humidifier or Related Abnormality

Error Code	AF
Method of Error Detection	Water leakage from humidifier(s) is detected based on the float switch ON/OFF changeover while the system is not operating.
Error Decision Conditions	The float switch changes from ON to OFF while the system is OFF.
Supposed Causes	<ul style="list-style-type: none"> ■ Defective float switch ■ Error in water drain system of humidifier(s) ■ Clogged electric expansion valve in humidifier(s) ■ Defective indoor unit PCB

Troubleshooting

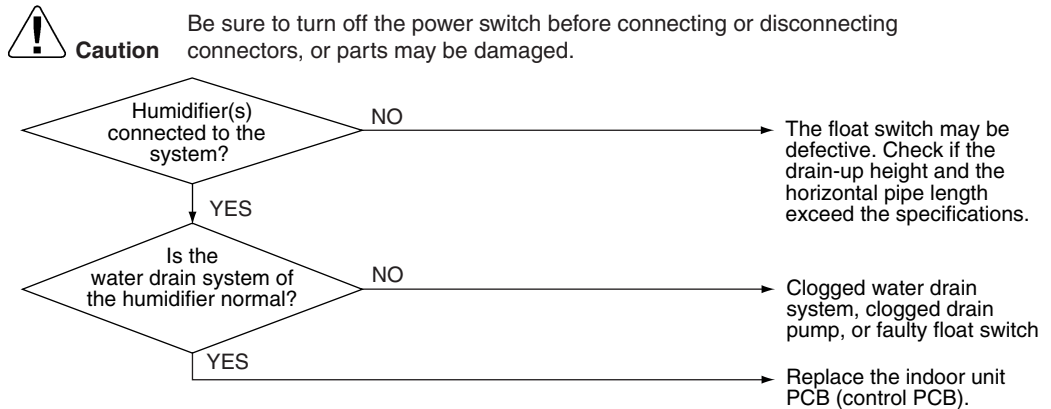

(R24055)

 **Note:** The system continues to operate with the thermostat OFF even while the error code is displayed.

6.5 Thermistor or Related Abnormality

Error Code

Ⓔ4, Ⓔ5, Ⓔ9

Method of Error Detection

The temperatures detected by the thermistors determine thermistor errors.

Error Decision Conditions

The thermistor is disconnected or shorted while the unit is running.

Supposed Causes

- Disconnection of connector
- Defective thermistor(s)
- Breaking of wires
- Defective indoor unit PCB

Troubleshooting



Check No.01
Refer to P.191

If the cause of the problem is related to the thermistors, the thermistors should be checked prior to changing the indoor unit PCB.

To check the thermistors, proceed as follows:

Step	Action
1	Disconnect the thermistor from the indoor unit PCB.
2	Read the temperature and the resistance value.
3	Check if the measured values correspond with the values in the table of thermistor resistance check.



Caution

Be sure to turn off the power switch before connecting or disconnecting connectors, or parts may be damaged.

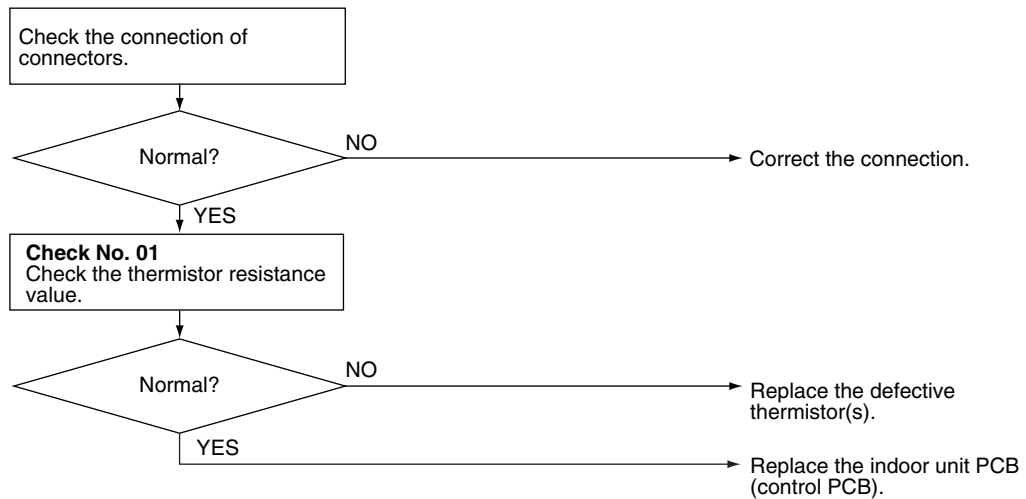

(R24056)

Ⓔ4 : Indoor heat exchanger thermistor 1 (liquid pipe) (R2T)

Ⓔ5 : Indoor heat exchanger thermistor 2 (R3T)

Ⓔ9 : Room temperature thermistor (R1T)



Note: When replacing the defective thermistor(s), replace the thermistors as ASSY.

6.6 Presence Sensor or Floor Sensor Abnormality

Error Code	EE
Method of Error Detection	The system detects abnormality by the output signal from the sensor(s).
Error Decision Conditions	The sensor is disconnected or shorted while the unit is running.
Supposed Causes	<ul style="list-style-type: none"> ■ Disconnection of connector ■ Breaking of wires ■ Defective sensor(s) ■ Defective sensor kit PCB

Troubleshooting If the cause of the problem is related to the sensors, the sensors should be checked prior to changing the indoor unit PCB.

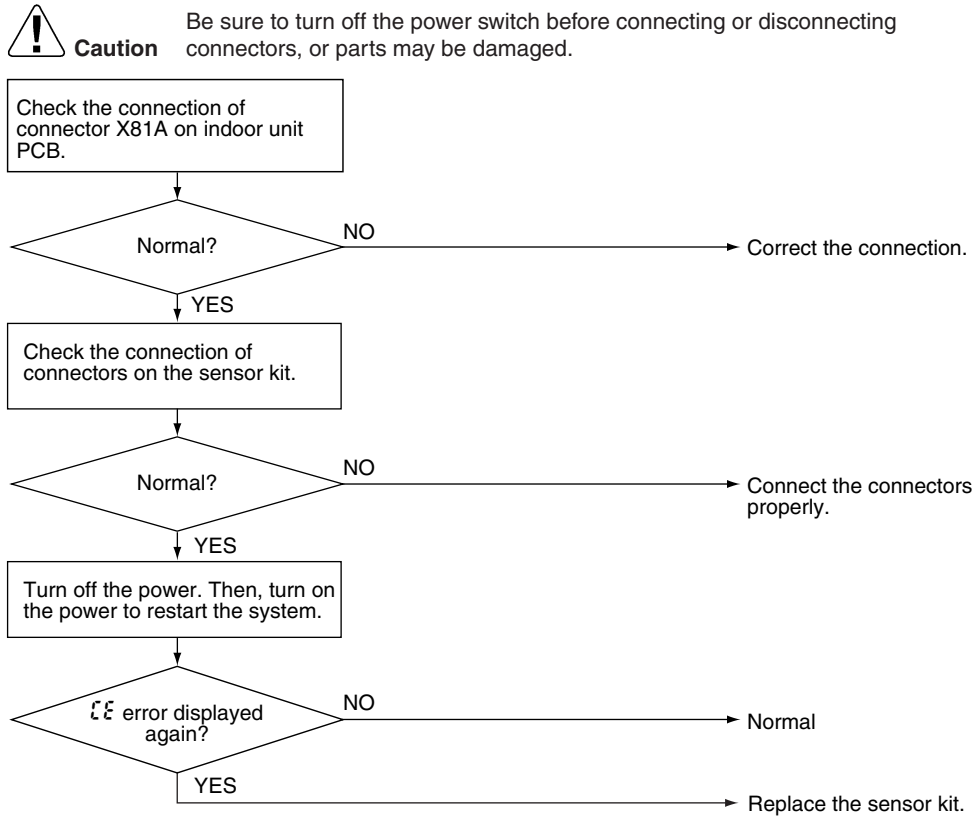

(R24577)

 **Note:** When replacing the defective sensor(s), replace the sensor kit as ASSY.

6.7 Remote Controller Thermistor Abnormality

Error Code

Ⓜ

Method of Error Detection

Even if remote controller thermistor is faulty, system is possible to operate by system thermistor. Malfunction detection is carried out by the temperature detected by the remote controller thermistor.

Error Decision Conditions

The remote controller thermistor is disconnected or shorted while the unit is running.

Supposed Causes

- Defective room temperature thermistor in the wired remote controller
- Defective wired remote controller PCB
- External factor such as noise

Troubleshooting



Caution

Be sure to turn off the power switch before connecting or disconnecting connectors, or parts may be damaged.

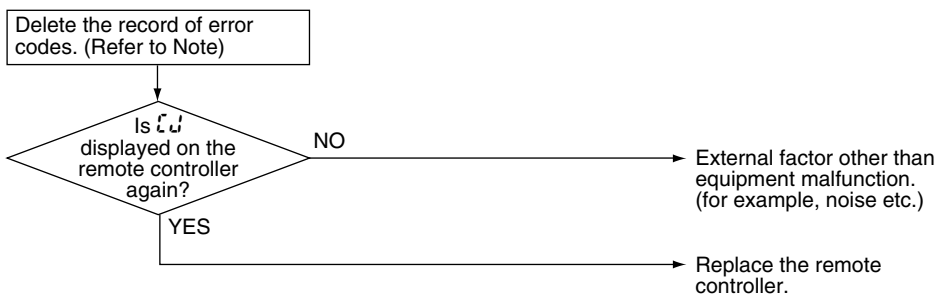

(R23951)



Note: To delete the record of error codes, press **ON/OFF** button for 4 seconds or more while the error code is displayed in the inspection mode.

6.8 Signal Transmission Error (Between Indoor Unit and Outdoor Unit)

Error Code	U4
Method of Error Detection	The signal transmission data from the outdoor unit is checked whether it is normal.
Error Decision Conditions	The data sent from the outdoor unit cannot be received normally, or the content of the data is abnormal.
Supposed Causes	<ul style="list-style-type: none">■ Power supply voltage out of specification■ Reduction of power supply voltage■ Wiring error■ Breaking of the connection wires between the indoor and outdoor units (wire No. 3)■ Defective outdoor unit PCB■ Short circuit inside the fan motor winding■ Defective indoor unit PCB■ Disturbed power supply waveform

Troubleshooting



Check No.11
Refer to P.193



Caution

Be sure to turn off the power switch before connecting or disconnecting connectors, or parts may be damaged.

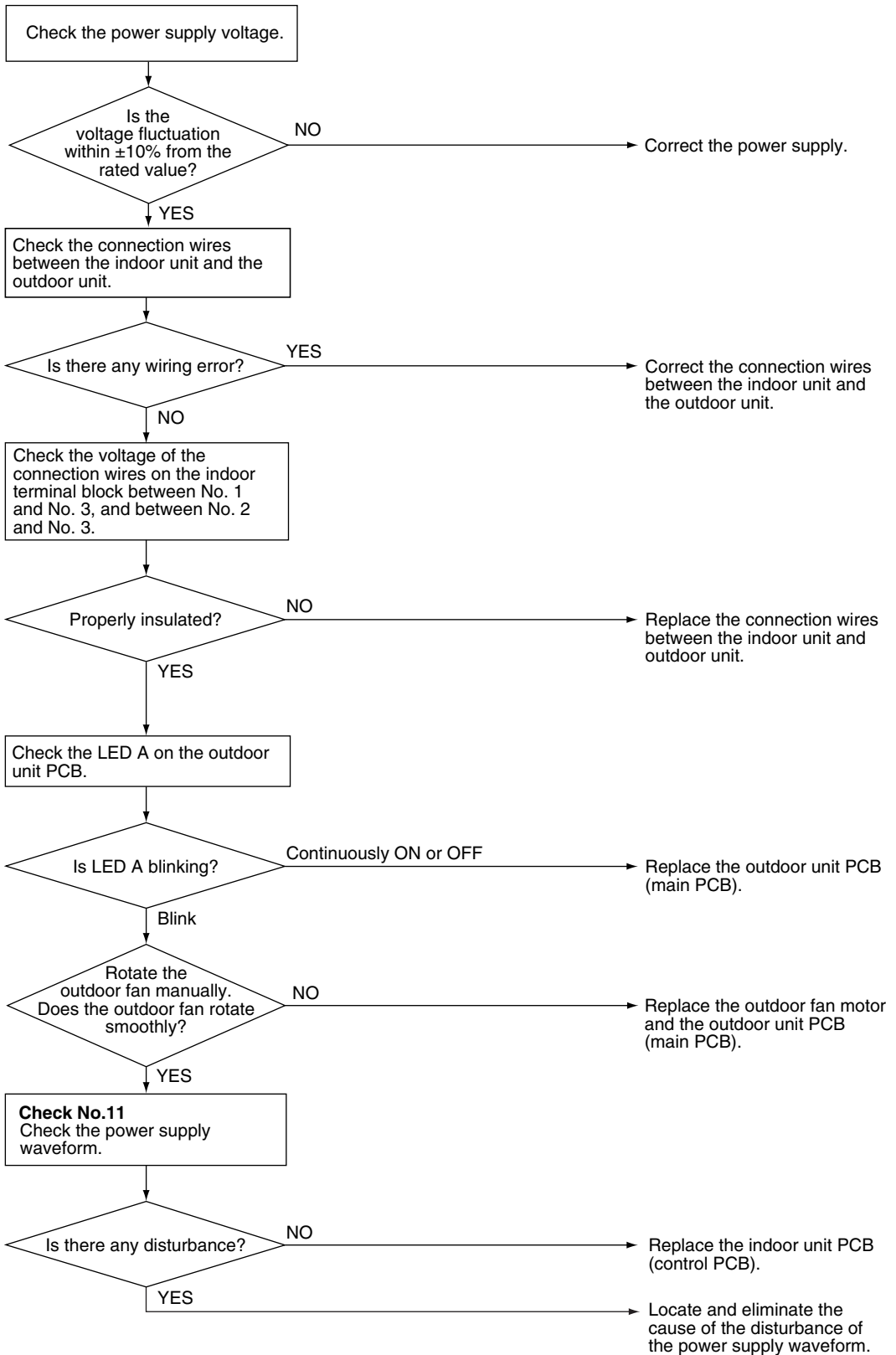

(R24622)

6.9 Signal Transmission Error (Between Indoor Unit and Remote Controller)

Error Code

U5

Method of Error Detection

In case of controlling 1 indoor unit with 2 remote controllers, check the system using microcomputer if signal transmission between indoor unit and remote controller (main and sub) is normal.

Error Decision Conditions

Normal transmission does not continue for specified period.

Supposed Causes

- Connection of 2 main remote controllers (when using 2 remote controllers)
- Defective indoor unit PCB
- Defective remote controller
- Transmission error caused by noise

Troubleshooting

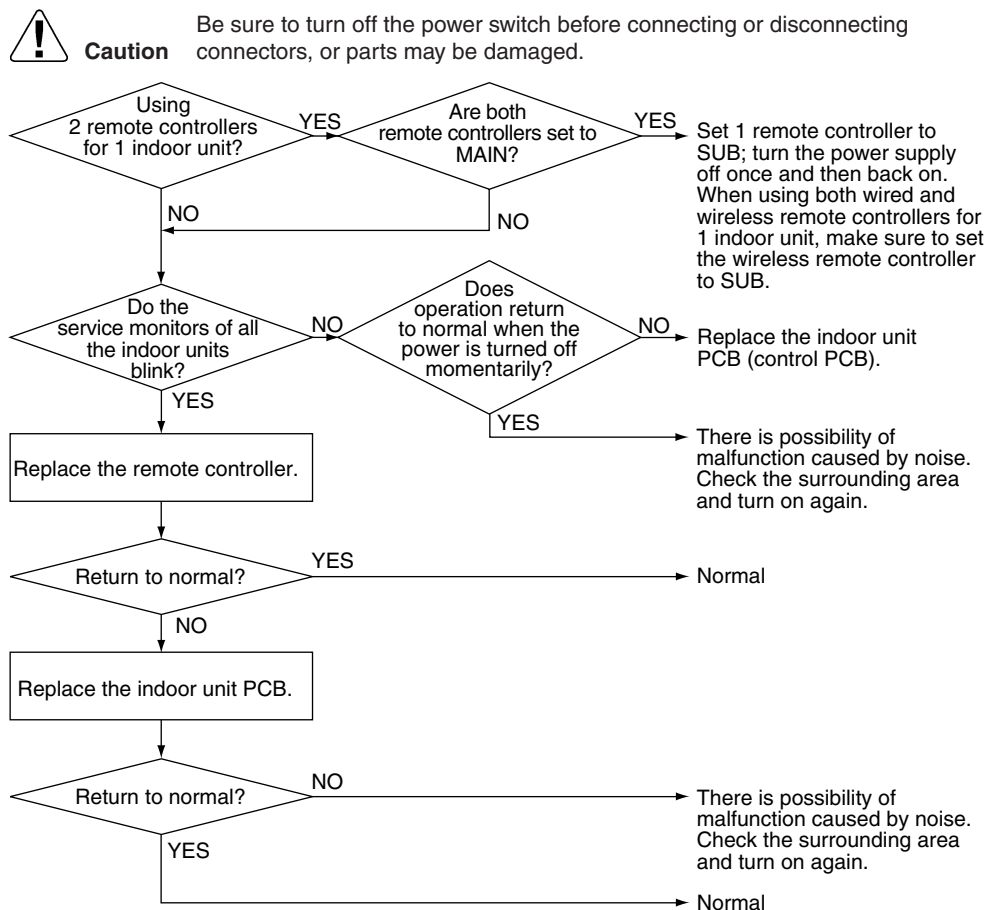

(R24590)



Note: For the way to change MAIN/SUB setting of remote controllers, refer to pages 223 and 224.

6.10 Signal Transmission Error (Between MAIN Remote Controller and SUB Remote Controller)

Error Code

U8

Method of Error Detection

In case of controlling 1 indoor unit with 2 remote controllers, check the system using microcomputer if signal transmission between MAIN remote controller and SUB remote controller is normal.

Error Decision Conditions

Normal transmission does not continue for specified period.

Supposed Causes

- Remote controller is set to SUB when using 1 remote controller
- Connection of 2 sub remote controllers (when using 2 remote controllers)
- Defective remote controller PCB

Troubleshooting



Caution

Be sure to turn off the power switch before connecting or disconnecting connectors, or parts may be damaged.

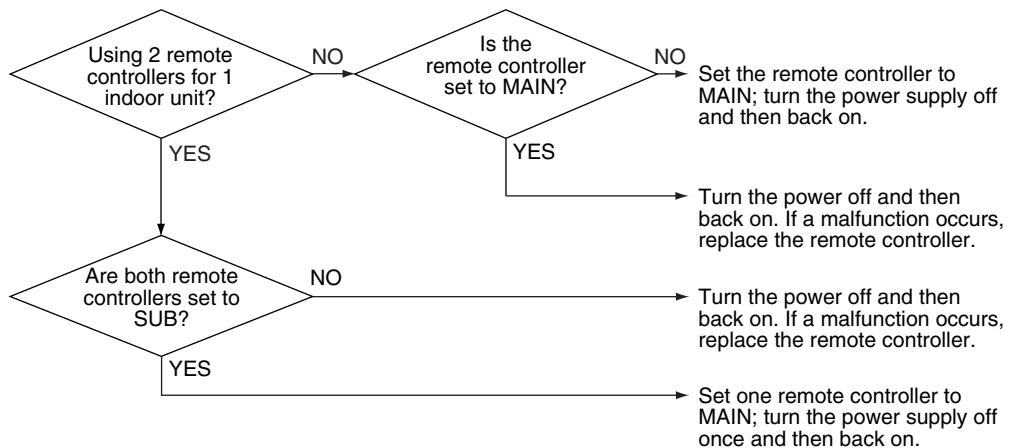

(R24058)



Note: For the way to change MAIN/SUB setting of remote controllers, refer to pages 223 and 224.

6.11 Mismatching of Indoor Unit and Outdoor Unit

Error Code



Error Decision Conditions

- Improper combination of indoor and outdoor units

Supposed Causes

- Defective indoor unit PCB
- Indoor-outdoor unit transmission wiring error
- Defective optional unit(s) wirings
- Improper power supply wiring of indoor unit
- Improper wiring of connecting wires between indoor/outdoor units

Troubleshooting



Caution

Be sure to turn off the power switch before connecting or disconnecting connectors, or parts may be damaged.

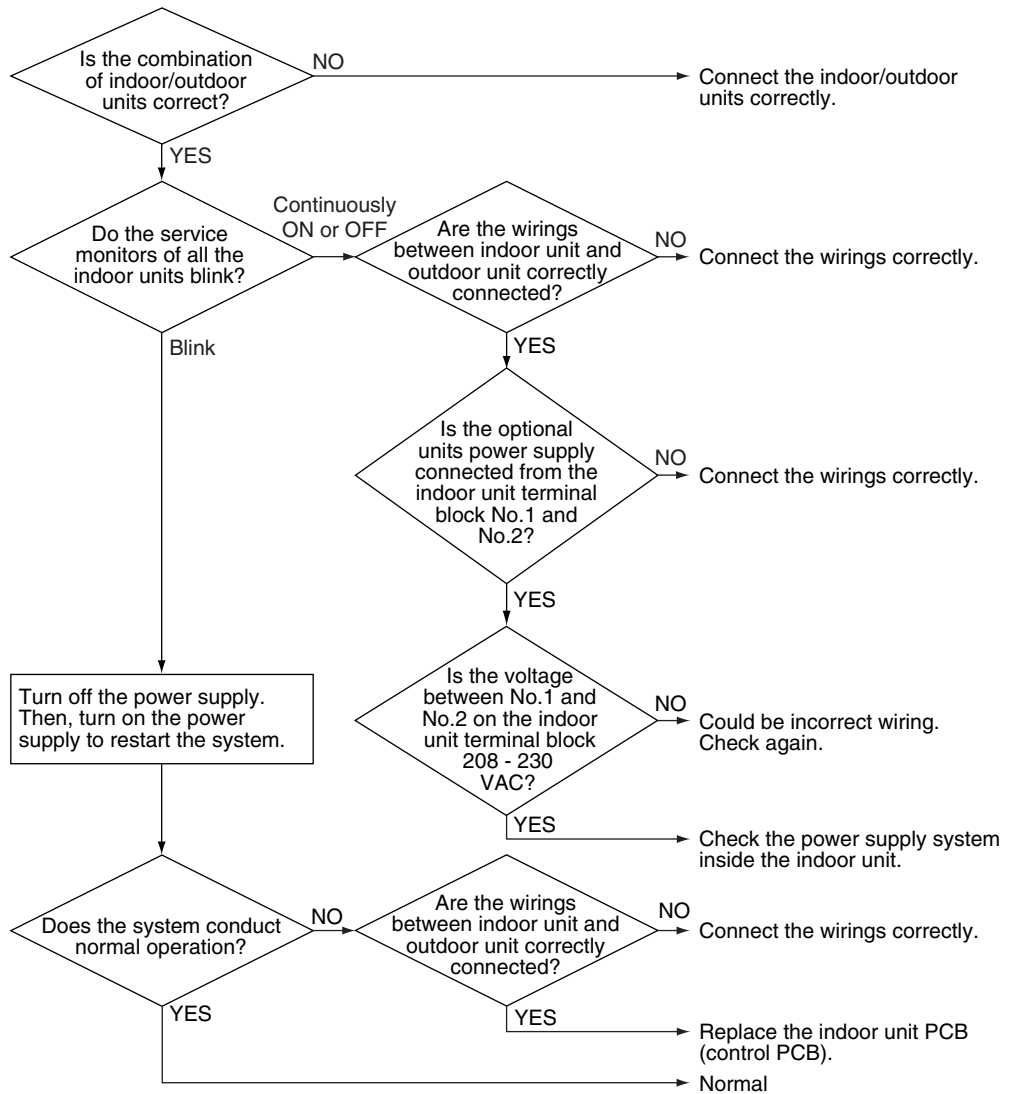

(R24591)

7. Troubleshooting for Outdoor Unit

7.1 Refrigerant Shortage

Error Code



Outdoor Unit LED Display

A 1 2 3 4 5

Method of Error Detection

Refrigerant shortage is detected by checking the input current value and the compressor running frequency. If there is insufficient refrigerant, the input current tends to be lower than the normal value.

Error Decision Conditions

The following conditions continue for 7 minutes.

- ◆ Input current $\leq A \times$ output frequency + B
- ◆ Output frequency > C

	A (-)	B (A)	C (Hz)
18 class	10/1000	0.3	54
24/36 class	27/1000	2	40

- If the error repeats, the system is shut down.
- Reset condition: Continuous run for about 60 minutes without any other error

Supposed Causes

- Disconnection of the discharge pipe thermistor, indoor or outdoor heat exchanger thermistor, room or outdoor temperature thermistor
- Closed stop valve
- Refrigerant shortage (refrigerant leakage)
- Poor compression performance of compressor
- Defective electronic expansion valve

Troubleshooting



Check No.01
Refer to P.191



Check No.12
Refer to P.194





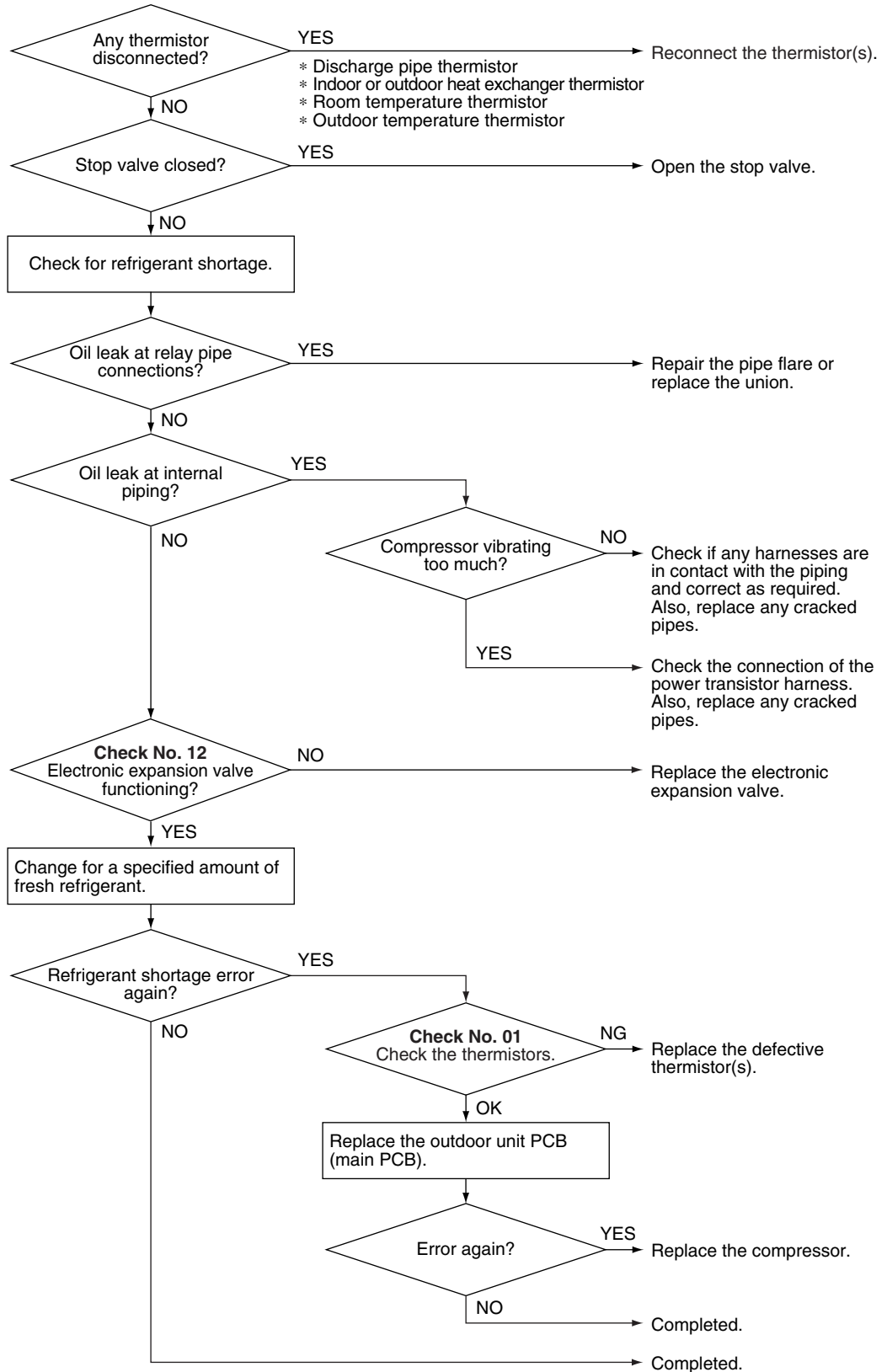



Caution Be sure to turn off the power switch before connecting or disconnecting connectors, or parts may be damaged.



(R23654)

7.2 Low-voltage Detection or Over-voltage Detection

Error Code	U2
Outdoor Unit LED Display	A  1  2  3  4  5 
Method of Error Detection	<p>★ Indoor Unit</p> <p>The zero-cross detection of the power supply is evaluated by the indoor unit PCB.</p> <p>★ Outdoor Unit</p> <p>Low-voltage detection: An abnormal voltage drop is detected by the DC voltage detection circuit.</p> <p>Over-voltage detection: An abnormal voltage rise is detected by the over-voltage detection circuit.</p>
Error Decision Conditions	<p>★ Indoor Unit</p> <p>There is no zero-cross detection in approximately 10 seconds.</p> <p>★ Outdoor Unit</p> <p>Low-voltage detection:</p> <ul style="list-style-type: none"> ■ The voltage detected by the DC voltage detection circuit is below 150 V for 0.1 second. ■ If the error repeats, the system is shut down. ■ Reset condition: Continuous run for about 60 minutes without any other error <p>Over-voltage detection:</p> <ul style="list-style-type: none"> ■ An over-voltage signal is fed from the over-voltage detection circuit to the microcomputer. ■ The compressor stops if the error occurs, and restarts automatically after 3-minute standby.
Supposed Causes	<ul style="list-style-type: none"> ■ Power supply voltage out of specification ■ Defective DC voltage detection circuit ■ Defective over-voltage detection circuit ■ Defective PAM control part ■ Disconnection of compressor harness ■ Short circuit inside the fan motor winding ■ Noise ■ Momentary drop of voltage ■ Momentary power failure ■ Defective outdoor unit PCB ■ Defective indoor unit PCB

Troubleshooting



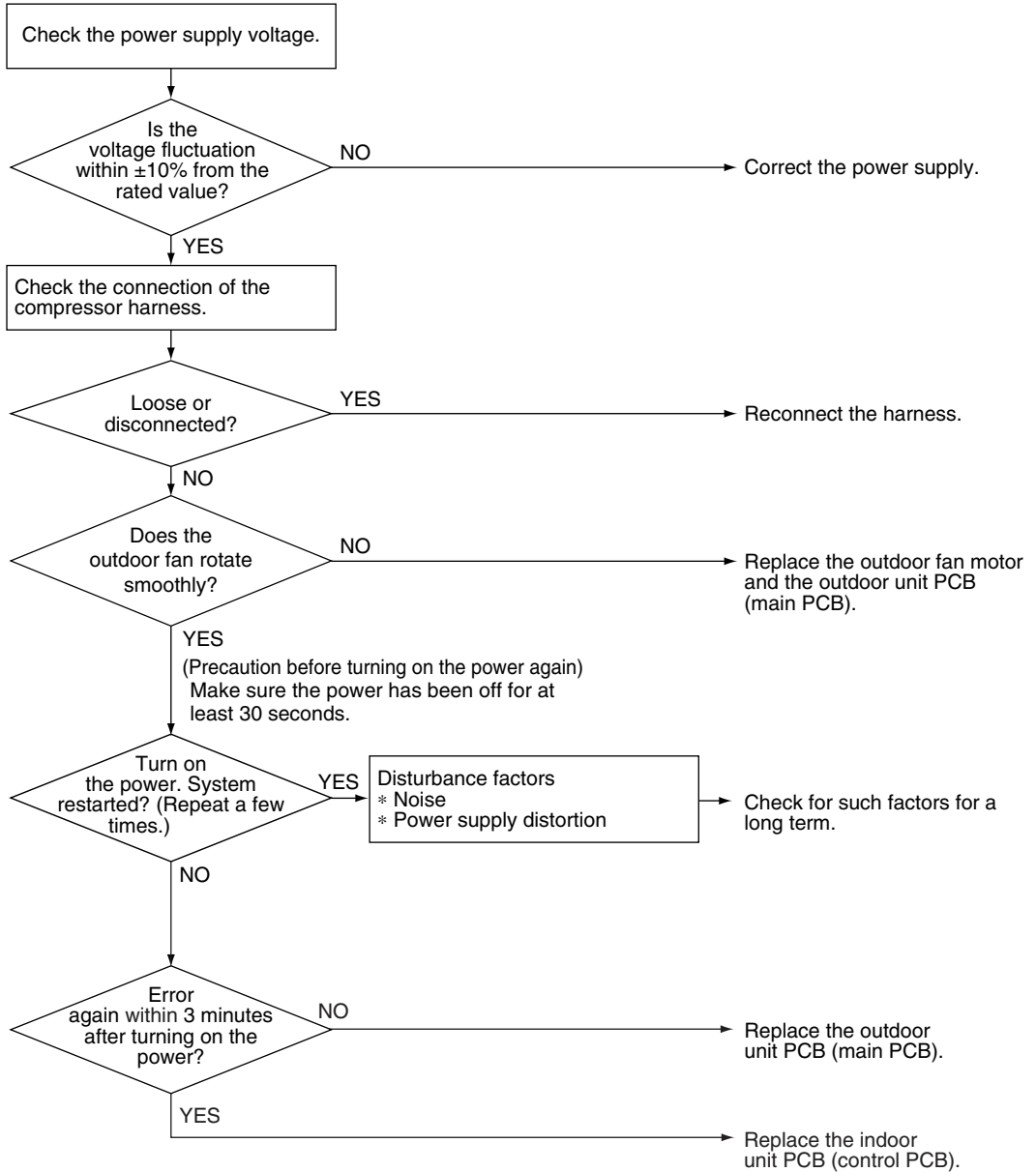

Caution Be sure to turn off the power switch before connecting or disconnecting connectors, or parts may be damaged.



(R22370)

7.3 Wiring Error Check Unexecuted

Error Code	U3
Outdoor Unit LED Display	A  1 ● 2  3 ● 4 ● 5 ●
Method of Error Detection	The system checks if wiring error check is executed after clearing the memory.
Error Decision Conditions	An error is determined when the unit is operated by the remote controller without executing wiring error check after the memory was cleared.
Supposed Causes	The wiring error switch (SW3) may have been pressed for 10 seconds or more and the memory may have been deleted. The unit cannot be operated unless wiring error check is executed.
Troubleshooting	

Caution

Be sure to turn off the power switch before connecting or disconnecting connectors, or parts may be damaged.

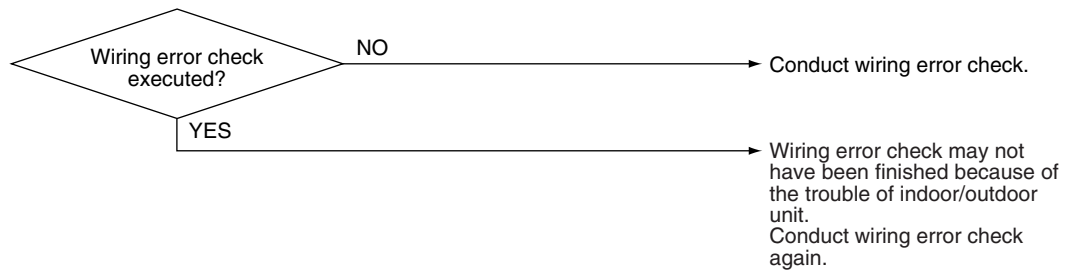





(R23952)



Note: Refer to wiring error check on page 205 for details.

7.4 Unspecified Voltage (Between Indoor Unit and Outdoor Unit)/Anti-icing Control in Other Rooms

Error Code	UR, UH
Outdoor Unit LED Display	A  1  2  3  4  5
Method of Error Detection	A wrong connection is detected by checking the combination of indoor and outdoor units on the microcomputer.
Error Decision Conditions	<ul style="list-style-type: none"> ■ Anti-icing control in other rooms ■ Unspecified internal and/or external voltages ■ Mismatching of indoor and outdoor units
Supposed Causes	<ul style="list-style-type: none"> ■ Anti-icing function in other rooms ■ Power supply voltage out of specification ■ Wrong models interconnected ■ Wrong indoor unit PCB or outdoor unit PCB mounted

Troubleshooting

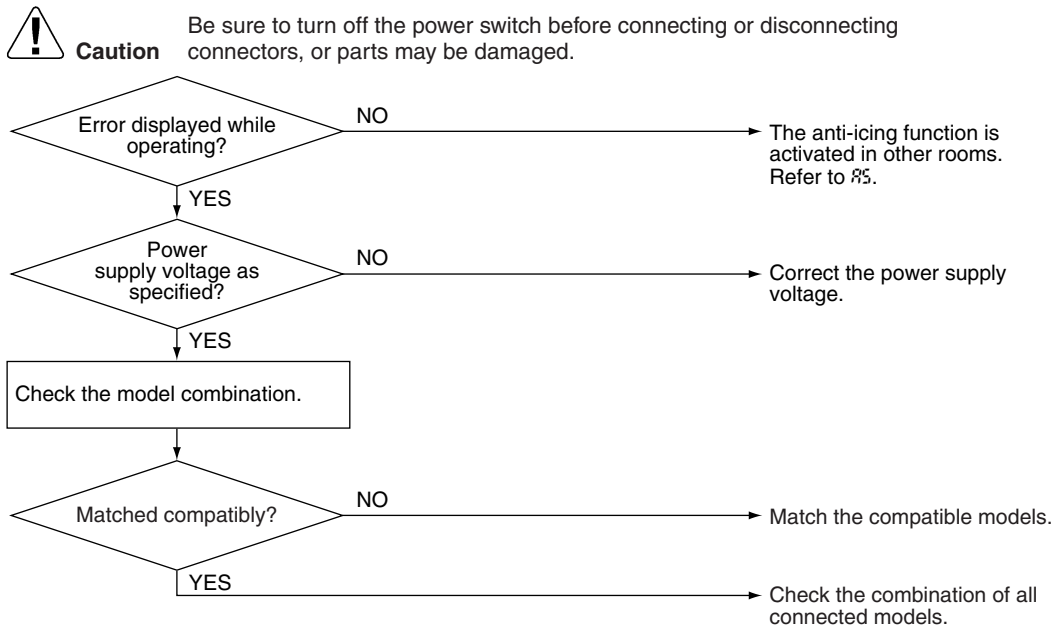





(R21922)



Note: Refer to Anti-icing control for indoor unit on page 167 for details.

7.5 Anti-icing Control for Indoor Unit

Error Code	A5
Outdoor Unit LED Display	A  1  2  3  4  5
Method of Error Detection	During cooling operation, indoor unit icing is detected by checking the temperatures sensed by the indoor heat exchanger thermistor and room temperature thermistor that are located in a shut-down room.
Error Decision Conditions	<ul style="list-style-type: none"> ■ In cooling operation, the both conditions (A) and (B) are met for 5 minutes. <ul style="list-style-type: none"> (A) Room temperature – Indoor heat exchanger temperature $\geq 10^{\circ}\text{C}$ (18°F) (B) Indoor heat exchanger temperature $\leq -1^{\circ}\text{C}$ (30.2°F) ■ If the error repeats, the system is shut down. ■ Reset condition: 3-minute standby is over and the indoor heat exchanger temperature is above 0°C (32°F)
Supposed Causes	<ul style="list-style-type: none"> ■ Wrong wiring or piping ■ Defective electronic expansion valve ■ Short-circuited air ■ Defective indoor heat exchanger thermistor ■ Defective room temperature thermistor

Troubleshooting



Check No.01
Refer to P.191



Check No.12
Refer to P.194





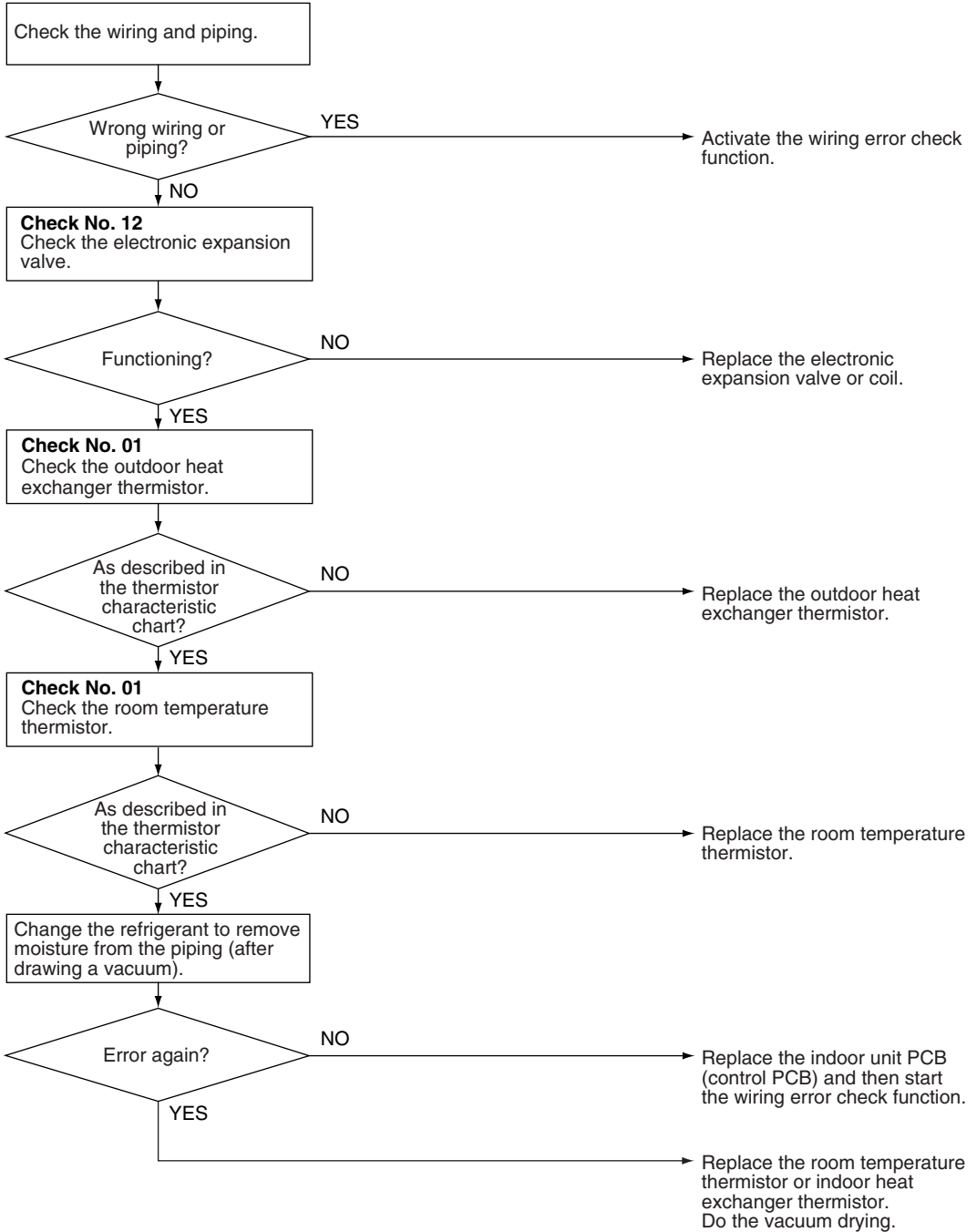

Caution

Be sure to turn off the power switch before connecting or disconnecting connectors, or parts may be damaged.



(R21923)

7.6 Outdoor Unit PCB Abnormality



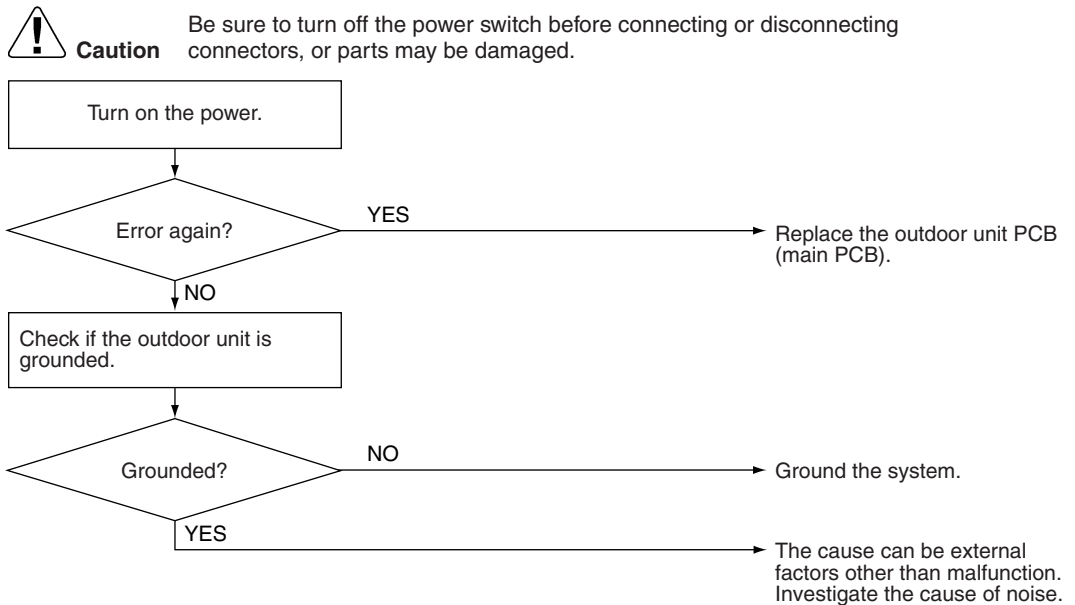

Error Code	E1
Outdoor Unit LED Display	A  1  2  3  4  5
Method of Error Detection	Detect within the program of the microcomputer.
Error Decision Conditions	The program of the microcomputer is in abnormal running order.
Supposed Causes	<ul style="list-style-type: none"> ■ Defective outdoor unit PCB ■ Noise ■ Momentary drop of voltage ■ Momentary power failure

Troubleshooting



(R21809)

7.7 OL Activation (Compressor Overload)

Error Code	E5
Outdoor Unit LED Display	A  1  2  3  4  5
Method of Error Detection	A compressor overload is detected through compressor OL.
Error Decision Conditions	<ul style="list-style-type: none"> ■ If the error repeats, the system is shut down. ■ Reset condition: Continuous run for about 60 minutes without any other error
Supposed Causes	<ul style="list-style-type: none"> ■ Disconnection of discharge pipe thermistor ■ Defective discharge pipe thermistor ■ Disconnection of connector S40 ■ Disconnection of 2 terminals of OL (Q1L) ■ Defective OL (Q1L) ■ Broken OL harness ■ Defective electronic expansion valve or coil ■ Defective four way valve or coil ■ Defective outdoor unit PCB ■ Refrigerant shortage ■ Water mixed in refrigerant ■ Defective stop valve

Troubleshooting



Check No.01
Refer to P.191



Check No.12
Refer to P.194



Check No.13
Refer to P.195



Check No.14
Refer to P.195



Caution Be sure to turn off the power switch before connecting or disconnecting connectors, or parts may be damaged.

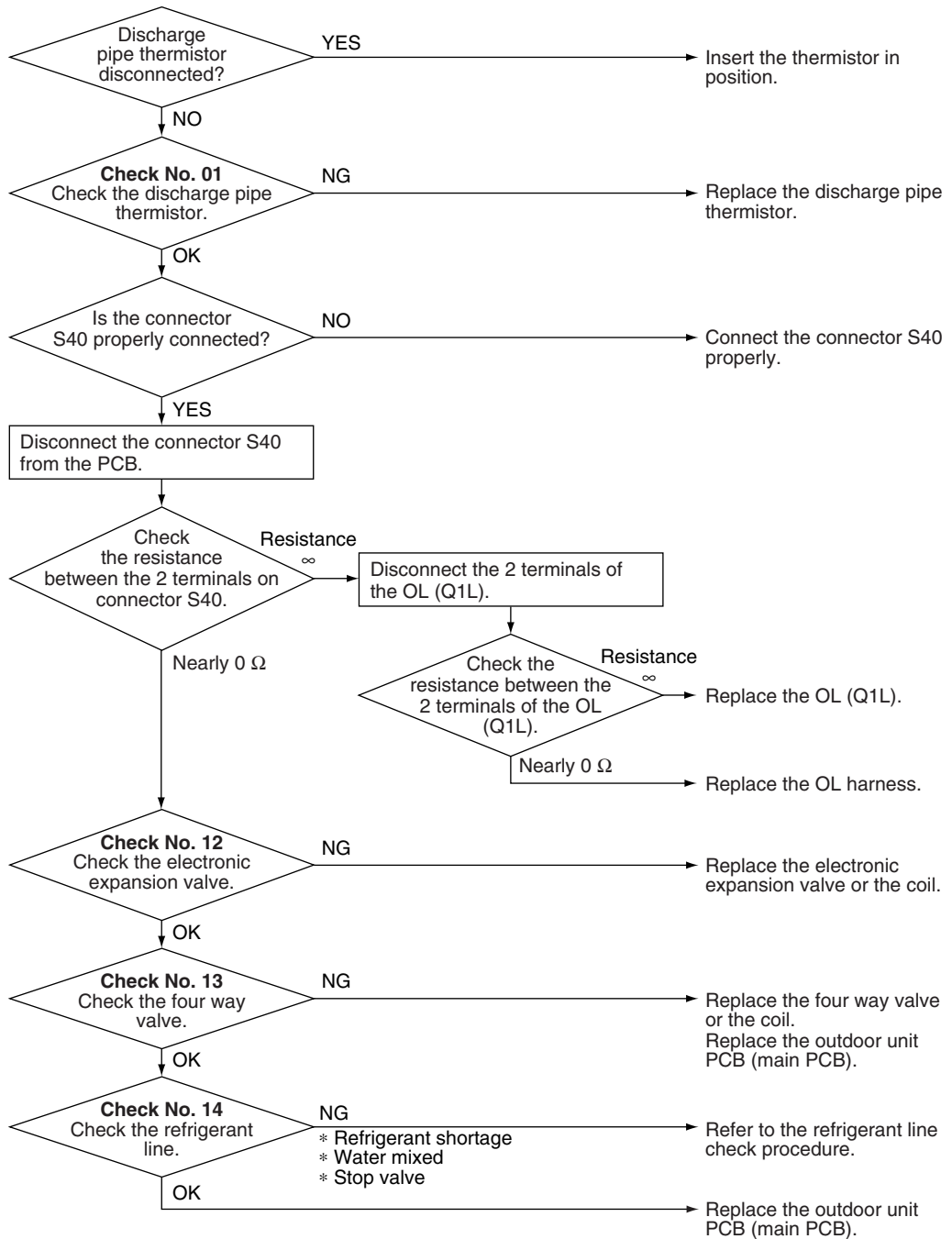

Note: OL (Q1L) activating temperature: 130°C (266°F)
OL (Q1L) recovery temperature: 95°C (203°F)

(R22970)

7.8 Compressor Lock

Error Code	EE
Outdoor Unit LED Display	A 1 ● 2 3 4 ● 5 ●
Method of Error Detection	A compressor lock is detected by checking the compressor running condition through the position detection circuit.
Error Decision Conditions	<ul style="list-style-type: none"> ■ Judging from the current waveform generated when high-frequency voltage is applied to the compressor. ■ If the error repeats, the system is shut down. ■ Reset condition: Continuous run for about 5 minutes without any other error
Supposed Causes	<ul style="list-style-type: none"> ■ Closed stop valve ■ Defective outdoor unit PCB ■ Defective compressor ■ Defective electronic expansion valve

Troubleshooting

Check No.12
Refer to P.194

Check No.15
Refer to P.196

Caution Be sure to turn off the power switch before connecting or disconnecting connectors, or parts may be damaged.
(Precaution before turning on the power again)
Make sure the power has been off for at least 30 seconds.

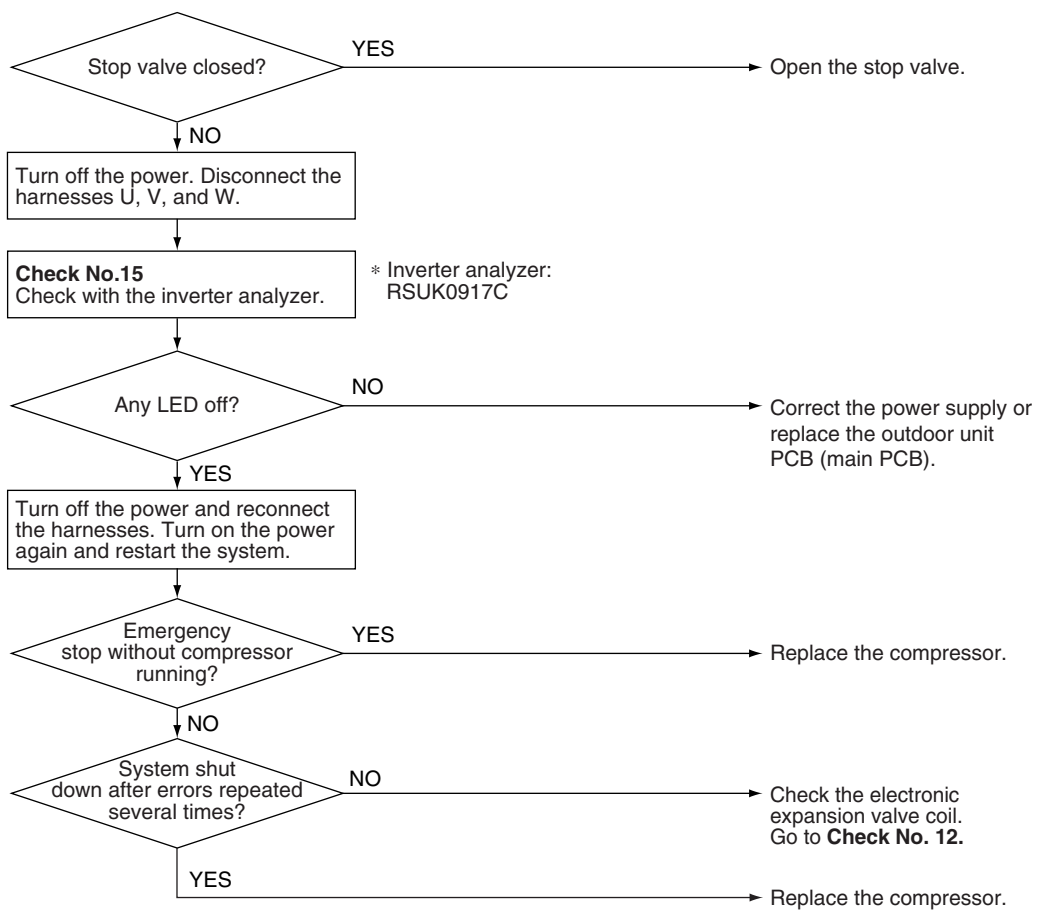

(R21067)

7.9 DC Fan Lock

Error Code	E7
Outdoor Unit LED Display	A ● 1 ○ 2 ○ 3 ○ 4 ○ 5 ●
Method of Error Detection	An error is determined with the high-voltage fan motor rotation speed detected by the Hall IC.
Error Decision Conditions	<ul style="list-style-type: none"> ■ The fan does not start in 30 seconds even when the fan motor is running. ■ If the error repeats, the system is shut down. ■ Reset condition: Continuous run for about 5 minutes without any other error
Supposed Causes	<ul style="list-style-type: none"> ■ Disconnection of the fan motor ■ Foreign matter stuck in the fan ■ Defective fan motor ■ Defective outdoor unit PCB

Troubleshooting



Check No.16
Refer to P.197

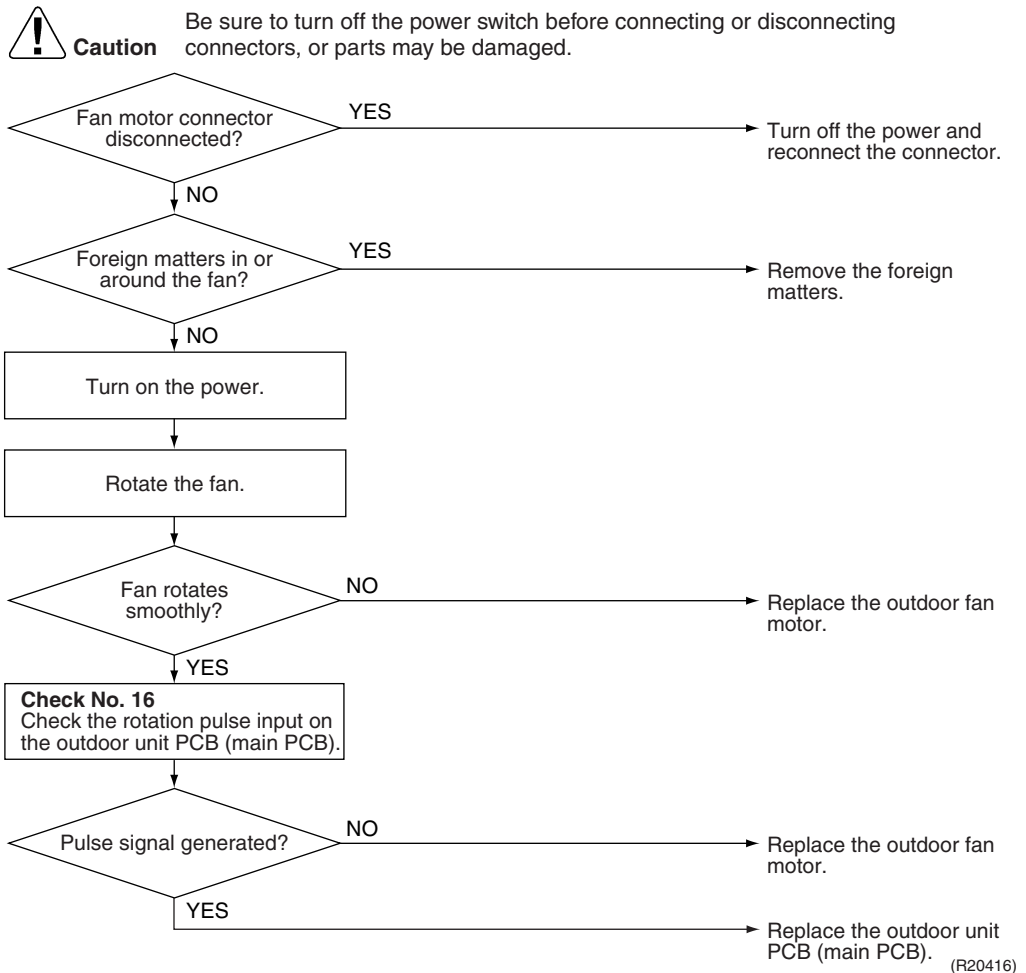

7.10 Input Overcurrent Detection

Error Code	EE
Outdoor Unit LED Display	A ● 1 ● 2 ● 3 ● 4 ● 5 ●
Method of Error Detection	Detected by checking the input current value
Error Decision Conditions	<ul style="list-style-type: none"> ■ The input current is at a certain value (depending on the condition) for 2.5 seconds. ■ The compressor halts if the error occurs, and restarts automatically after 3-minute standby.
Supposed Causes	<ul style="list-style-type: none"> ■ Outdoor temperature is out of operation range. ■ Defective compressor ■ Defective power module ■ Defective outdoor unit PCB ■ Short circuit

Troubleshooting

 **Check No.15**
Refer to P.196

 **Check No.17**
Refer to P.198

 **Check No.18**
Refer to P.198

 **Caution** Be sure to turn off the power switch before connecting or disconnecting connectors, or parts may be damaged.
* An input overcurrent may result from wrong internal wiring. If the system is interrupted by an input overcurrent after the wires have been disconnected and reconnected for part replacement, check the wiring again.

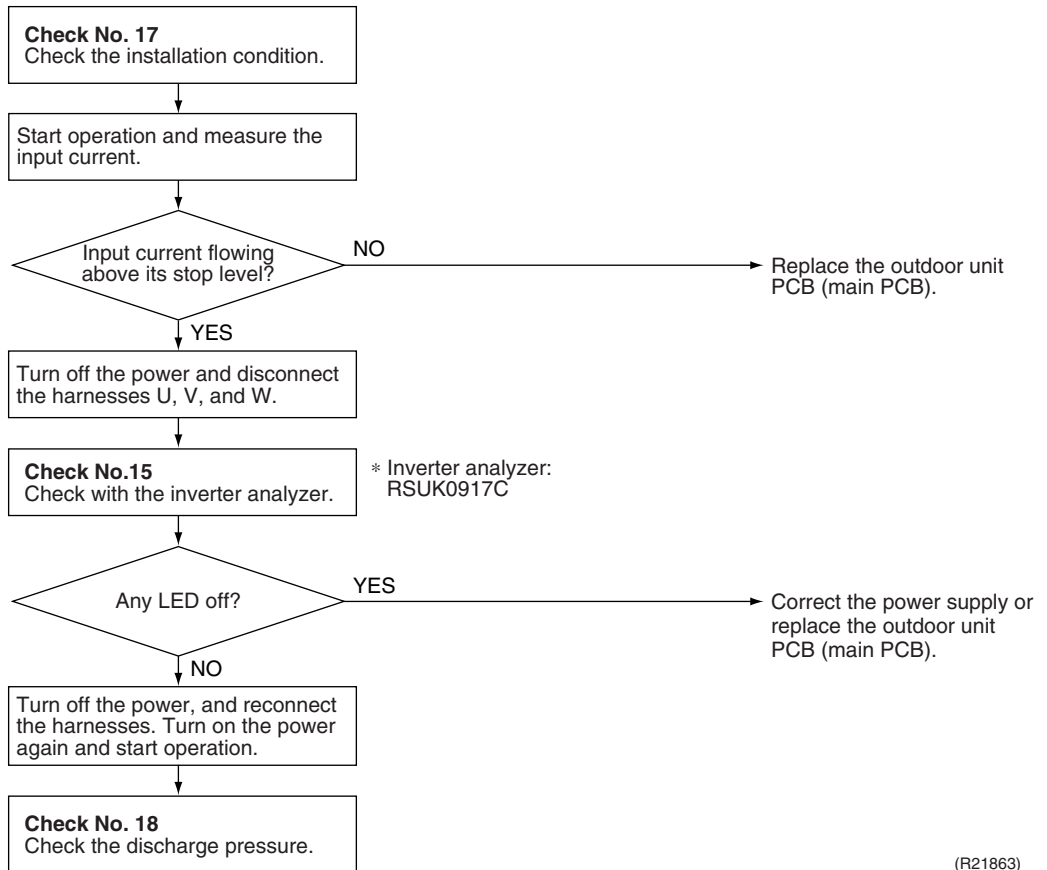

(R21863)

7.11 Four Way Valve Abnormality

Error Code

EA

Outdoor Unit LED Display

A  1  2  3  4  5

Method of Error Detection

The liquid pipe thermistor and the outdoor heat exchanger thermistor are checked to see if they function within their normal ranges in the operating mode.

Error Decision Conditions

The following condition continues for **A** seconds after the compressor has started.

	Cooling	Heating
A (seconds)	240	1

- Cooling operation
The lowest liquid pipe temperature among the rooms in operation –Tde > 45°C (81°F)
- Heating operation
The highest liquid pipe temperature among the rooms in operation –Tde < 0°C (0°F)

Tde: outdoor heat exchanger temperature

Supposed Causes

- Disconnection of four way valve coil
- Defective four way valve, coil, or harness
- Defective outdoor unit PCB
- Defective thermistor
- Refrigerant shortage
- Water mixed in refrigerant
- Defective stop valve

Troubleshooting



Check No.01
Refer to P.191



Check No.13
Refer to P.195



Check No.14
Refer to P.195



Caution Be sure to turn off the power switch before connecting or disconnecting connectors, or parts may be damaged.

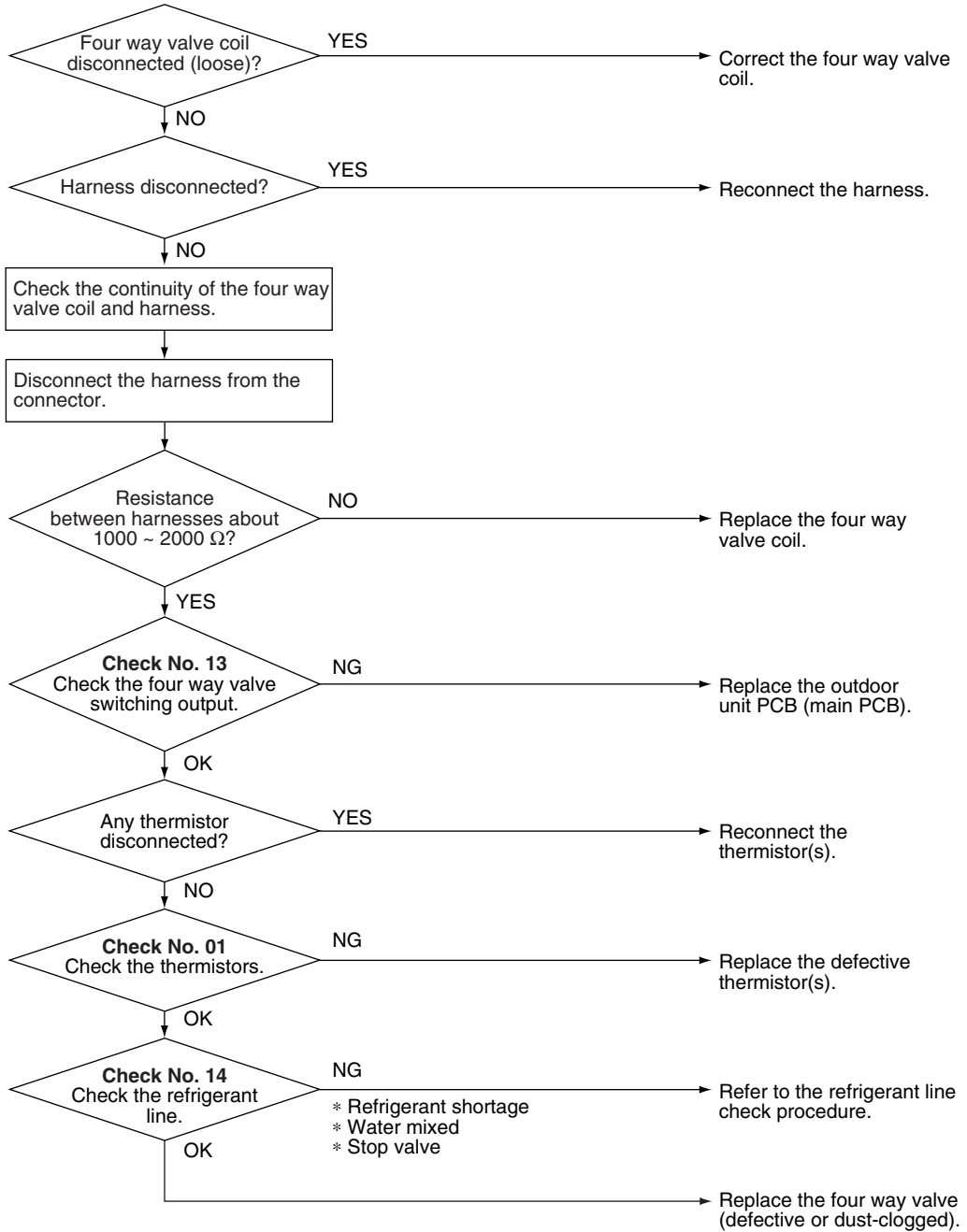

(R20405)

7.12 Discharge Pipe Temperature Control

Error Code



Outdoor Unit LED Display

A 1 2 3 4 5

Method of Error Detection

An error is determined with the temperature detected by the discharge pipe thermistor.

Error Decision Conditions

- If the temperature detected by the discharge pipe thermistor rises above **A**, the compressor stops.
- The error is cleared when the discharge pipe temperature is dropped below **B**.

	A	B
18 class	120°C (248°F)	95°C (203°F)
24/36 class	120°C (248°F)	107°C (224.6°F)

- If the error repeats, the system is shut down.
- Reset condition: Continuous run for about 60 minutes without any other error

Supposed Causes

- Defective discharge pipe thermistor
(Defective outdoor heat exchanger thermistor or outdoor temperature thermistor)
- Defective electronic expansion valve or coil
- Refrigerant shortage
- Defective four way valve
- Water mixed in refrigerant
- Defective stop valve
- Defective outdoor unit PCB

Troubleshooting



Check No.01
Refer to P.191



Check No.12
Refer to P.194







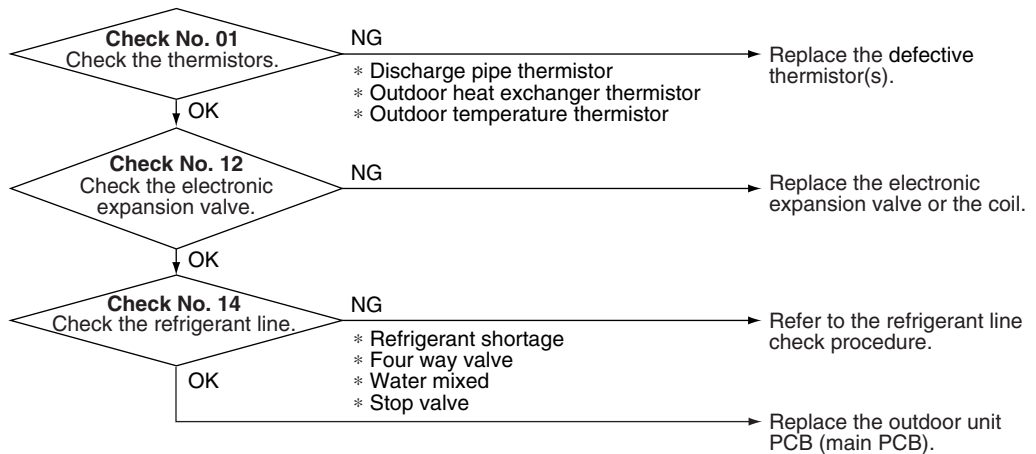

Check No.14
Refer to P.195







Caution Be sure to turn off the power switch before connecting or disconnecting connectors, or parts may be damaged.



7.13 High Pressure Control in Cooling

Error Code	F6
Outdoor Unit LED Display	A  1  2  3  4  5 
Method of Error Detection	High pressure control (operation halt, frequency drop, etc.) is activated in cooling operation if the temperature sensed by the outdoor heat exchanger thermistor exceeds the limit.
Error Decision Conditions	<ul style="list-style-type: none"> ■ The temperature sensed by the outdoor heat exchanger thermistor rises above about 65°C (149°F). ■ The error is cleared when the temperature drops below about 49.5°C (121.1°F).
Supposed Causes	<ul style="list-style-type: none"> ■ The installation space not large enough ■ Dirty outdoor heat exchanger ■ Defective outdoor fan motor ■ Defective stop valve ■ Defective electronic expansion valve or coil ■ Defective outdoor heat exchanger thermistor ■ Defective outdoor unit PCB

Troubleshooting

- 
Check No.01
Refer to P.191
- 
Check No.12
Refer to P.194
- 
Check No.17
Refer to P.198
- 
Check No.18
Refer to P.198
- 
Check No.19
Refer to P.199

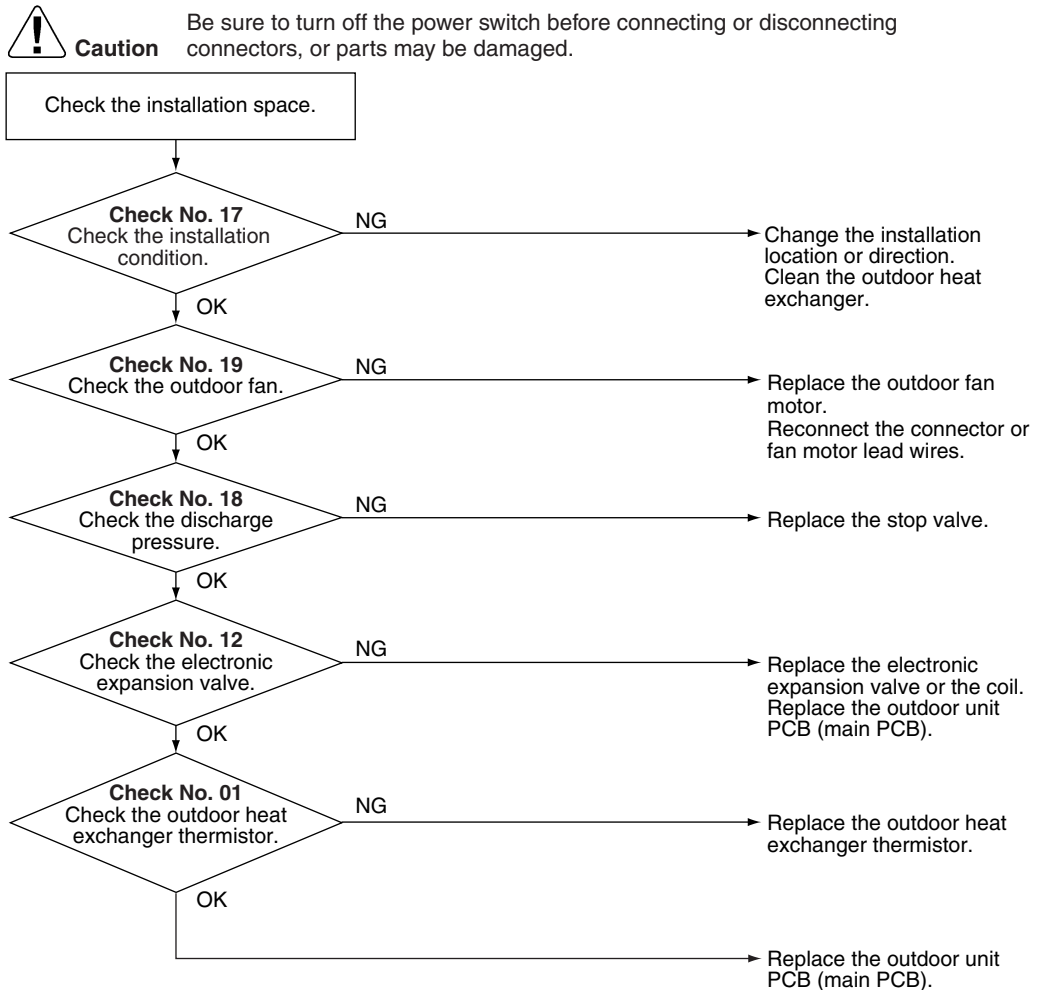

(R20418)

7.14 Compressor Sensor System Abnormality

Error Code

H0

Outdoor Unit LED Display

A  1  2  3  4  5

Method of Error Detection

- The system checks the power supply voltage and the DC voltage before the compressor starts.
- The system checks the DC current of the compressor right after the compressor starts.

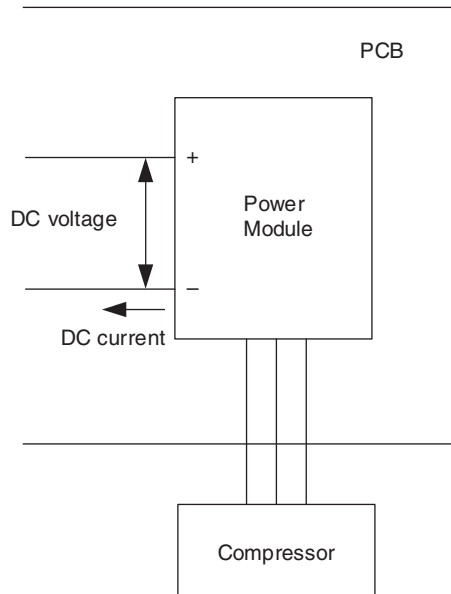

(R22001)

Error Decision Conditions

- The power supply voltage and the DC voltage is obviously low or high.
- The DC current of the compressor does not flow when the compressor starts.

Supposed Causes



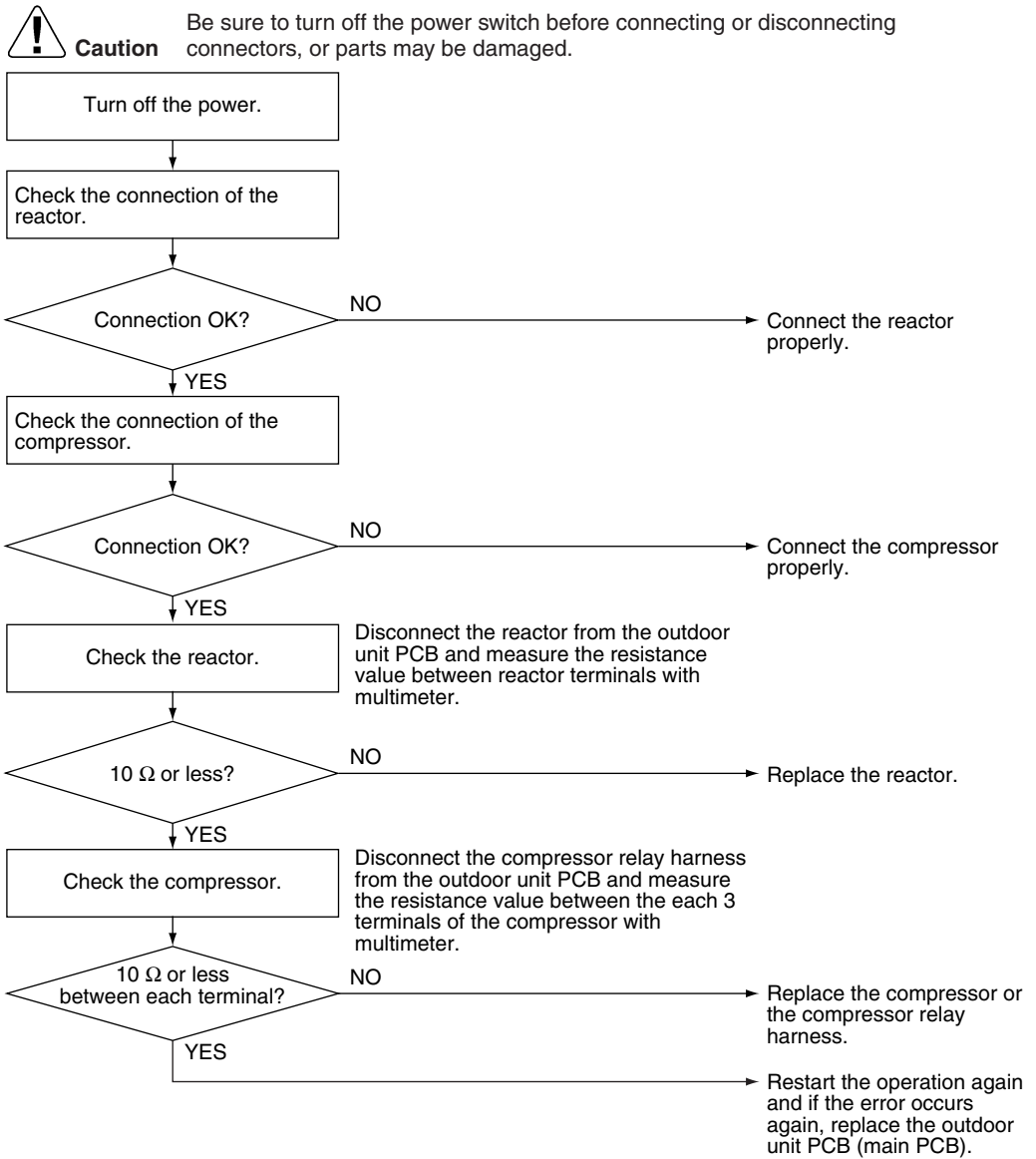

- Disconnection of reactor
- Disconnection of compressor harness
- Defective outdoor unit PCB
- Defective compressor

Troubleshooting



(R20419)

7.15 Position Sensor Abnormality

Error Code	H6
Outdoor Unit LED Display	A  1  2  3  4  5
Method of Error Detection	A compressor start-up failure is detected by checking the compressor running condition through the position detection circuit.
Error Decision Conditions	<ul style="list-style-type: none"> ■ If the error repeats, the system is shut down. ■ Reset condition: Continuous run for about 5 minutes without any other error
Supposed Causes	<ul style="list-style-type: none"> ■ Power supply voltage out of specification ■ Disconnection of the compressor harness ■ Defective compressor ■ Defective outdoor unit PCB ■ Start-up failure caused by the closed stop valve ■ Input voltage is outside the specified range.

Troubleshooting



Check No.15
Refer to P.196



Check No.18
Refer to P.198



Check No.20
Refer to P.199



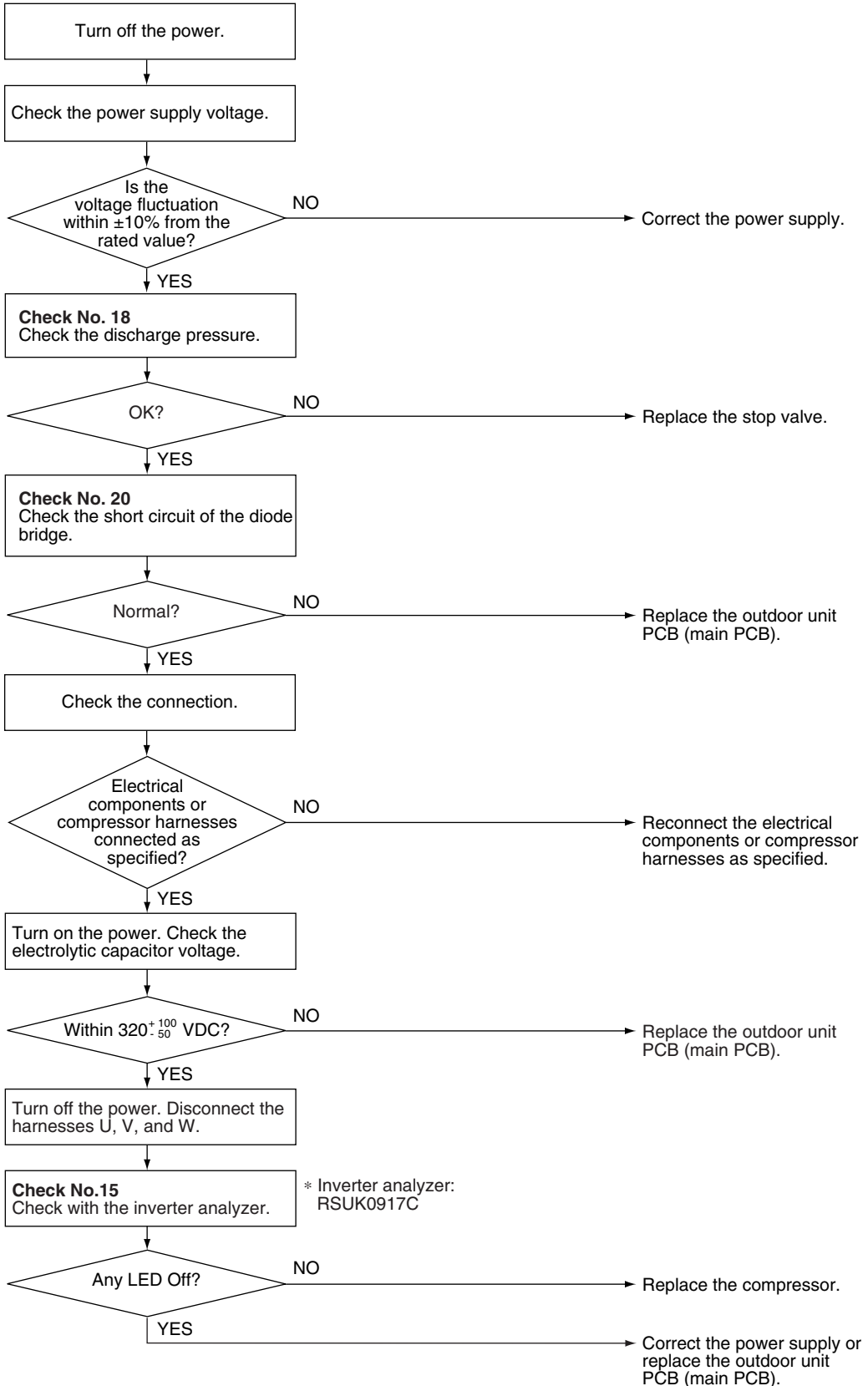

Caution Be sure to turn off the power switch before connecting or disconnecting connectors, or parts may be damaged.



(R22564)

7.16 CT or Related Abnormality

Error Code	H8									
Outdoor Unit LED Display	A  1  2  3 ● 4 ● 5 ●									
Method of Error Detection	A CT or related error is detected by checking the compressor running frequency and CT-detected input current.									
Error Decision Conditions	<ul style="list-style-type: none"> ■ The compressor running frequency is more than A Hz and input current is less than B A. <table border="1"> <thead> <tr> <th></th> <th>A (Hz)</th> <th>B (A)</th> </tr> </thead> <tbody> <tr> <td>18/24 class</td> <td>32</td> <td>0.5</td> </tr> <tr> <td>36 class</td> <td>55</td> <td>0.5</td> </tr> </tbody> </table> <ul style="list-style-type: none"> ■ If the error repeats, the system is shut down. ■ Reset condition: Continuous run for about 60 minutes without any other error 		A (Hz)	B (A)	18/24 class	32	0.5	36 class	55	0.5
	A (Hz)	B (A)								
18/24 class	32	0.5								
36 class	55	0.5								
Supposed Causes	<ul style="list-style-type: none"> ■ Defective power module ■ Broken or disconnected wiring ■ Defective reactor ■ Defective outdoor unit PCB 									

Troubleshooting



Check No.15
Refer to P.196



Check No.21
Refer to P.200



Caution Be sure to turn off the power switch before connecting or disconnecting connectors, or parts may be damaged.

Turn off the power. Then, turn on the power to restart the system.

Start operation.

* Running current as shown at right with relay cable 1 or 2?

YES

Replace the outdoor unit PCB (main PCB).

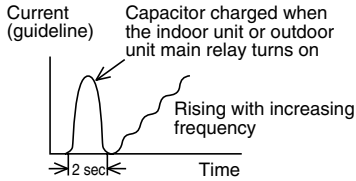

Check No. 21
Check the capacitor voltage.

Within $320 + \frac{100}{50}$ VDC?

YES

Turn off the power. Disconnect the harnesses U, V, and W.

Check No.15
Check with the inverter analyzer.

* Inverter analyzer: RSUK0917C

Any LED OFF?

YES

Correct the power supply or replace the outdoor unit PCB (main PCB).

NO

Turn off the power and reconnect the harnesses. Then turn on the power again and restart operation.

Compressor running?

NO

Replace the compressor.

YES

Replace the outdoor unit PCB (main PCB).

Voltage within the allowable range (Power supply voltage $\pm 15\%$)?

NO







Check the power supply voltage.

YES

Replace the outdoor unit PCB (main PCB).

(R22271)

7.17 Thermistor or Related Abnormality (Outdoor Unit)

Error Code	<i>H3, U3, U6, U8, U9, P4</i>
Outdoor Unit LED Display	A  1  2  3  4  5
Method of Error Detection	This fault is identified based on the thermistor input voltage to the microcomputer. A thermistor fault is identified based on the temperature sensed by each thermistor.
Error Decision Conditions	<ul style="list-style-type: none"> ■ The voltage between the both ends of the thermistor is above 4.96 V or below 0.04 V with the power on. ■ <i>U3</i> error is judged if the discharge pipe temperature is lower than the heat exchanger temperature. ■ The system is shut down if all the units are judged as the <i>U8</i> error.
Supposed Causes	<ul style="list-style-type: none"> ■ Disconnection of the connector for the thermistor ■ Thermistor corresponding to the error code is defective. ■ Defective heat exchanger thermistor in the case of <i>U3</i> error (outdoor heat exchanger thermistor in cooling operation, or indoor heat exchanger thermistor in heating operation) ■ Defective outdoor unit PCB
Troubleshooting	<p>In case of <i>P4</i></p> <p> Caution Be sure to turn off the power switch before connecting or disconnecting connectors, or parts may be damaged.</p> <p>Replace the outdoor unit PCB (main PCB).</p> <p><i>P4</i> : Radiation fin thermistor</p>

Troubleshooting

In case of *H9, J3, J5, J8, J9*

Check No.01
 Refer to P.191



Caution

Be sure to turn off the power switch before connecting or disconnecting connectors, or parts may be damaged.

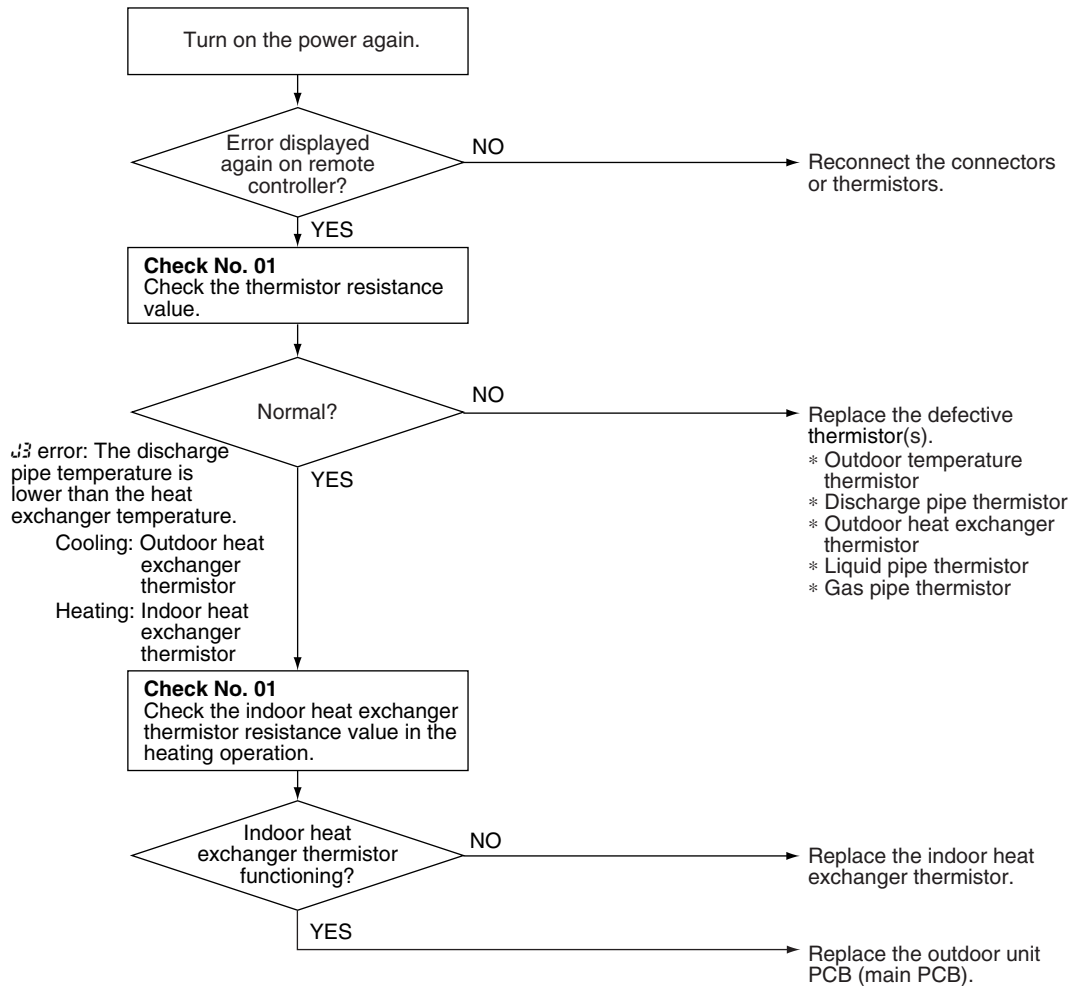

(R21118)

- H9* : Outdoor temperature thermistor
- J3* : Discharge pipe thermistor
- J5* : Outdoor heat exchanger thermistor
- J8* : Liquid pipe thermistor
- J9* : Gas pipe thermistor



Note: When replacing the defective thermistor(s), replace the thermistors as ASSY.

7.18 Electrical Box Temperature Rise

Error Code



Outdoor Unit LED Display

A 1 2 3 4 5

Method of Error Detection

An electrical box temperature rise is detected by checking the radiation fin thermistor with the compressor off.

Error Decision Conditions

- With the compressor off, the radiation fin temperature is above **A**.
- The error is cleared when the temperature drops below **B**.
- To cool the electrical components, the outdoor fan starts when the radiation fin temperature rises above **C** and stops when it drops below **B**.

A	B	C
100°C (212°F)	70°C (158°F)	85°C (185°F)

Supposed Causes

- Defective outdoor fan motor
- Short circuit
- Defective radiation fin thermistor
- Disconnection of connector
- Defective outdoor unit PCB

Troubleshooting

Check No.17
Refer to P.198

Check No.19
Refer to P.199

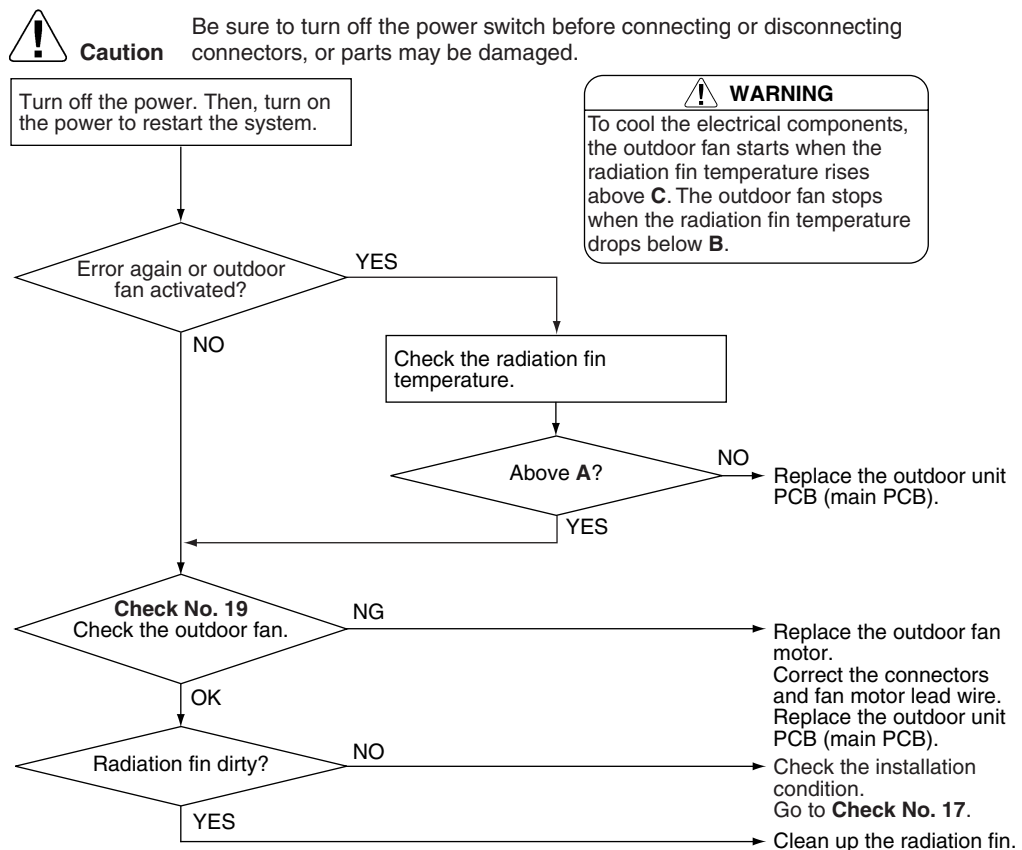

(R22272)

7.19 Radiation Fin Temperature Rise

Error Code

L4

Outdoor Unit LED Display

A 1 ● 2 ● 3 ● 4 5 ●

Method of Error Detection

A radiation fin temperature rise is detected by checking the radiation fin temperature with the compressor on.

Error Decision Conditions

- The radiation fin temperature with the compressor on is above **A**.
- The error is cleared when the temperature drops below **B**.

A	B
90°C (194°F)	85°C (185°F)

- If the error repeats, the system is shut down.
- Reset condition: Continuous run for about 60 minutes without any other error

Supposed Causes

- Defective outdoor fan motor
- Short circuit
- Defective radiation fin thermistor
- Disconnection of connector
- Defective outdoor unit PCB
- Silicone grease not applied properly on the radiation fin after replacing the outdoor unit PCB

Troubleshooting



Check No.17
Refer to P.198



Check No.19
Refer to P.199



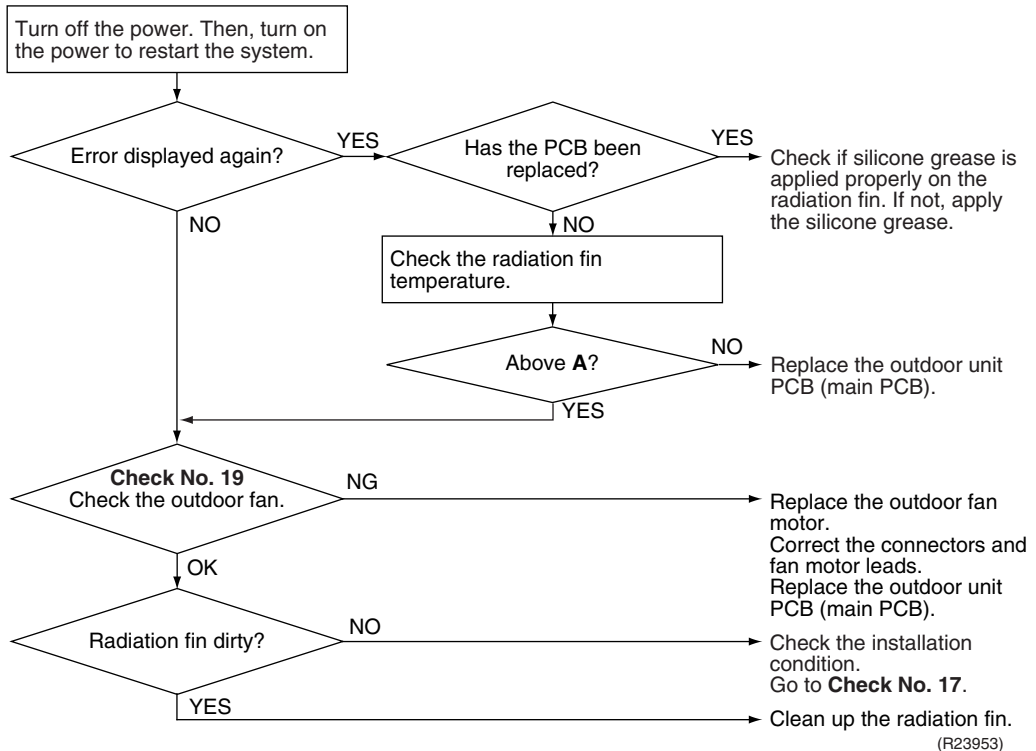

Caution

Be sure to turn off the power switch before connecting or disconnecting connectors, or parts may be damaged.



Note: Refer to Silicone Grease on Power Transistor/Diode Bridge on page 227 for details.

7.20 Output Overcurrent Detection

Error Code	L5
Outdoor Unit LED Display	A  1 ● 2 ● 3  4 ● 5 ●
Method of Error Detection	An output overcurrent is detected by checking the current that flows in the inverter DC section.
Error Decision Conditions	<ul style="list-style-type: none"> ■ A position signal error occurs while the compressor is running. ■ A rotation speed error occurs while the compressor is running. ■ An output overcurrent signal is fed from the output overcurrent detection circuit to the microcomputer. ■ If the error repeats, the system is shut down. ■ Reset condition: Continuous run for about 5 minutes without any other error
Supposed Causes	<ul style="list-style-type: none"> ■ Poor installation condition ■ Closed stop valve ■ Defective power module ■ Wrong internal wiring ■ Abnormal power supply voltage ■ Defective outdoor unit PCB ■ Supply voltage out of specification ■ Defective compressor

Troubleshooting



Check No.15
Refer to P.196



Check No.17
Refer to P.198



Check No.18
Refer to P.198



Check No.22
Refer to P.201



Caution Be sure to turn off the power switch before connecting or disconnecting connectors, or parts may be damaged.

* An output overcurrent may result from wrong internal wiring. If the system is interrupted by an output overcurrent after the wires have been disconnected and reconnected for part replacement, check the wiring again.

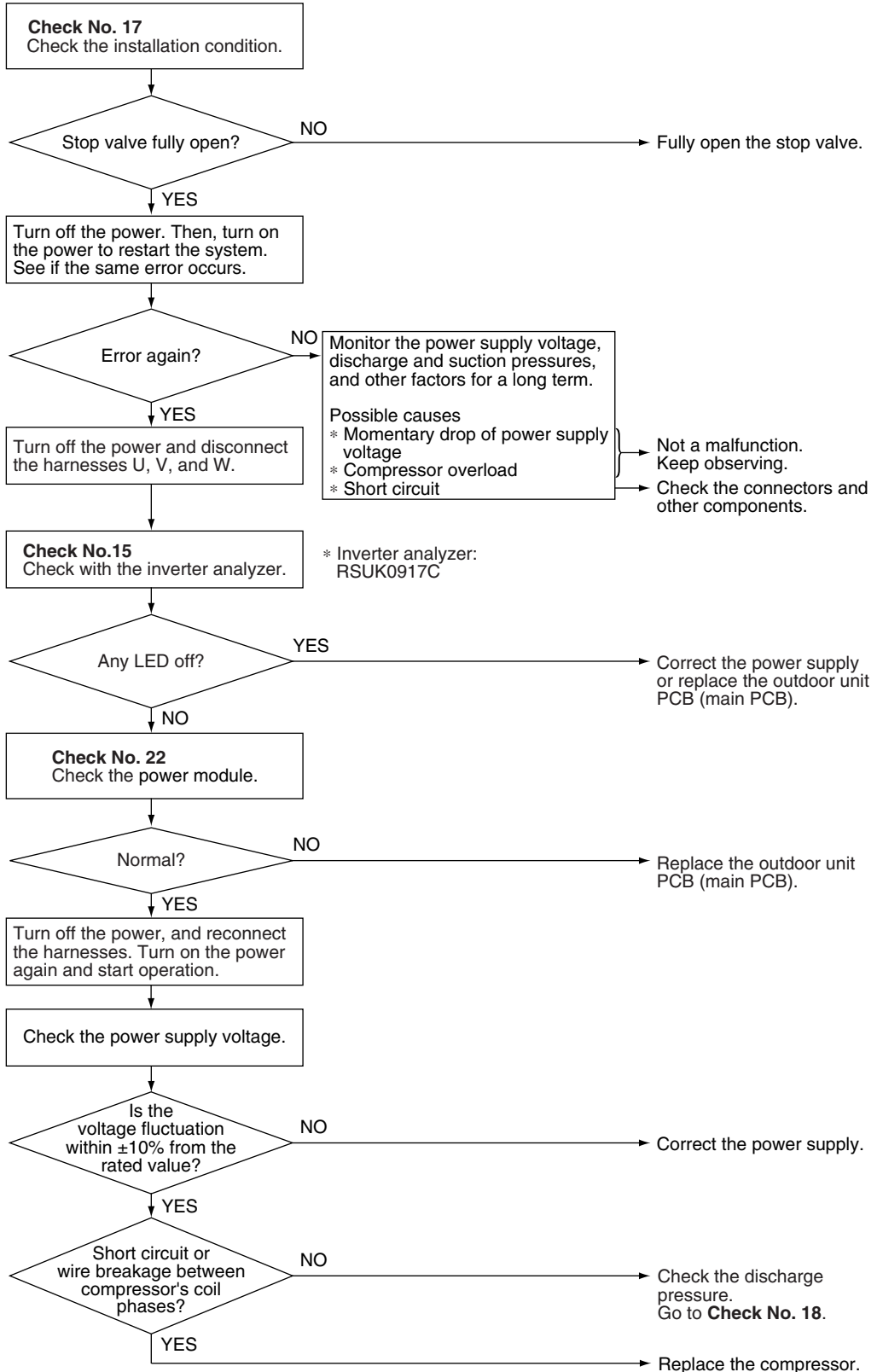

(R22566)

8. Check

8.1 Thermistor Resistance Check

Check No.01

Disconnect the connectors of the thermistors from the PCB, and measure the resistance of each thermistor using a multimeter.

The data is for reference purpose only.

Thermistor temperature		Resistance (kΩ)
°C	°F	
-20	-4	197.8
-15	5	148.2
-10	14	112.1
-5	23	85.60
0	32	65.93
5	41	51.14
10	50	39.99
15	59	31.52
20	68	25.02
25	77	20.00
30	86	16.10
35	95	13.04
40	104	10.62
45	113	8.707
50	122	7.176

(R25°C (77°F) = 20 kΩ, B = 3950 K)

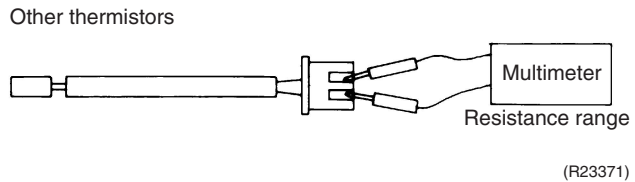
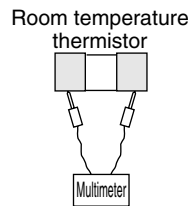
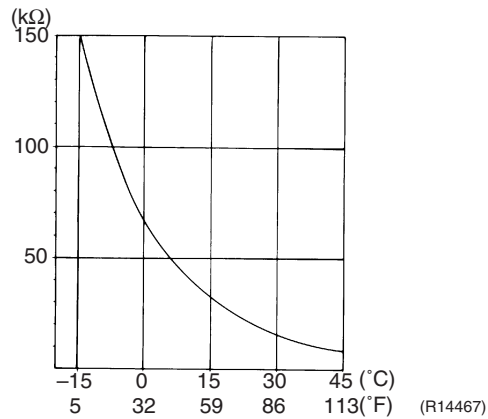

- When the room temperature thermistor is soldered on a PCB, remove the PCB from the control PCB to measure the resistance.
- When the connector of indoor heat exchanger thermistor is soldered on a PCB, remove the thermistor and measure the resistance.

8.2 Indoor Fan Motor Connector Check

Check No.02

CTXG, CTXS, FTXS, FVXS Series

1. Check the connection of connector.
2. Check motor power supply voltage output (pins 4 - 7).
3. Check motor control voltage (pins 4 - 3).
4. Check rotation command voltage output (pins 4 - 2).
5. Check rotation pulse input (pins 4 - 1).

S1 or S200

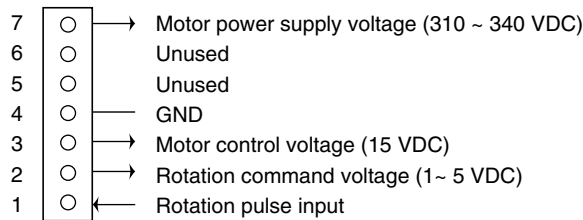

(R14225)

FFQ Series

1. Check the connection of connector.
2. Check motor power supply voltage output (pins 5 - 8).
3. Check motor control voltage (pins 5 - 4).
4. Check rotation command voltage output (pins 5 - 3).

X20A

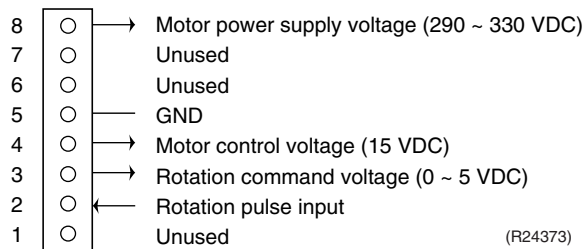

(R24373)

8.3 Hall IC Check

Check No.04

CDXS, FDXS Series

1. Check the connector connection.
2. With the power on, operation off, and the connector connected, check the following.
 - (1) Output voltage of about 5 V between pins 1 and 3.
 - (2) Generation of 3 pulses between pins 2 and 3 when the indoor fan motor is operating.

If NG in step (1) → Defective PCB → Replace the PCB (control PCB).

If NG in step (2) → Defective Hall IC → Replace the indoor fan motor.

If OK in both steps (1) and (2) → Replace the PCB (control PCB).

S7

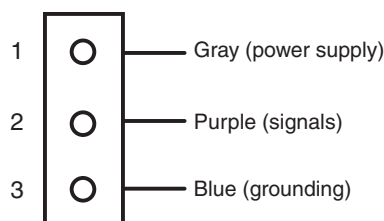

(R14211)

8.4 Power Supply Waveform Check

Check No.11

Measure the power supply waveform between No. 1 and No. 2 on the terminal board, and check the waveform disturbance.

- Check if the power supply waveform is a sine wave (Fig.1).
- Check if there is waveform disturbance near the zero-cross (sections circled in Fig.2)

[Fig.1]

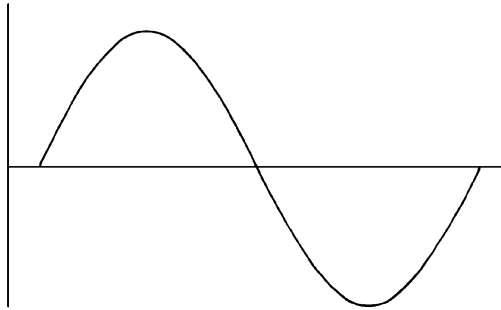

(R1736)

[Fig.2]

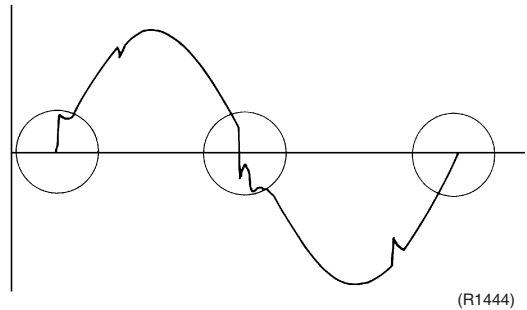

(R1444)

8.5 Electronic Expansion Valve Check

Check No.12

Conduct the following to check the electronic expansion valve (EV).

1. Check if the EV connector is correctly inserted in the PCB. Match the EV unit number and the connector number.
2. Turn the power off and on again, and check if all the EVs generate a latching sound.
3. If any of the EVs does not generate a latching sound in the above step 2, disconnect that connector and check the continuity using a multimeter.
Check the continuity between the pins 5 - 1, 5 - 2, 5 - 3, 5 - 4. If there is no continuity between the pins, the EV coil is faulty.
4. If no EV generates a latching sound in the above step 2, the outdoor unit PCB is faulty.
5. If the continuity is confirmed in the above step 3, mount a good coil (which generated a latching sound) in the EV unit that did not generate a latching sound, and check if that EV generates a latching sound.
*If a latching sound is generated, the outdoor unit PCB is faulty.
*If a latching sound is not generated, the EV unit is faulty.



Note: Please note that the latching sound varies depending on the valve type.

If the system keeps operating with a defective electronic expansion valve, the following problem may occur.

Valve opening position	Possible problem	Check method
Open	<p>Cooling:</p> <ul style="list-style-type: none"> ■ Flowing noise of refrigerant in the unit which is not in operation ■ Water leakage at the unit which is not in operation ■ Operation half due to anti-icing function <p>Heating:</p> <ul style="list-style-type: none"> ■ Flowing noise of refrigerant in the unit which is not in operation ■ The unit does not heat the room. 	<p>Reset power supply and conduct cooling operation unit by unit.</p> <p>Check the liquid pipe temperature of no-operation unit.</p> <p>Almost the same as the outdoor temperature?</p> <p>NO → The EV is not defective.</p> <p>YES → Replace the EV of the room. (R16019)</p>
Close	<p>Cooling:</p> <ul style="list-style-type: none"> ■ The problem unit does not cool the room. ■ Only the problem unit is in operation, the unit starts pump down. (The low pressure of the unit becomes vacuum.) ■ Abnormal discharge pipe temperature <p>Heating:</p> <ul style="list-style-type: none"> ■ Refrigerant shortage due to stagnation of liquid refrigerant inside the faulty indoor unit ■ The unit does not heat the room. ■ Abnormal discharge pipe temperature 	<p>Reset power supply and conduct cooling operation unit by unit.</p> <p>Check the low pressure.</p> <p>Does the pressure become into vacuum zone?</p> <p>NO → The EV is not defective.</p> <p>YES → Replace the EV of the room. (R16020)</p>

8.6 Four Way Valve Performance Check

Check No.13

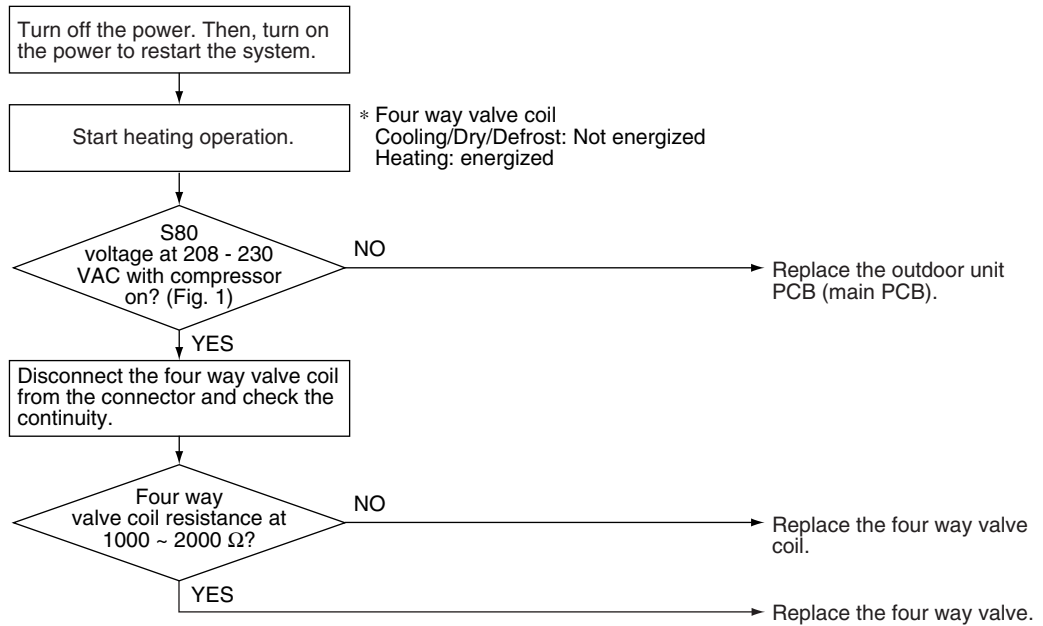

(R21936)

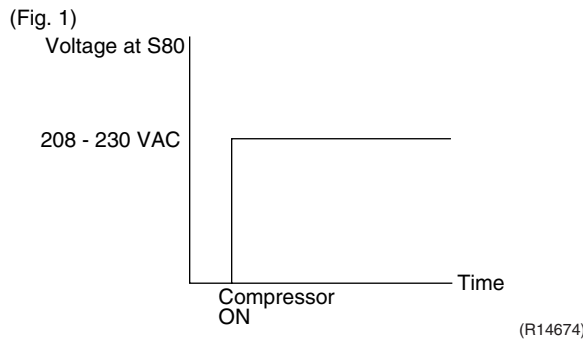

8.7 Inverter Unit Refrigerant System Check

Check No.14

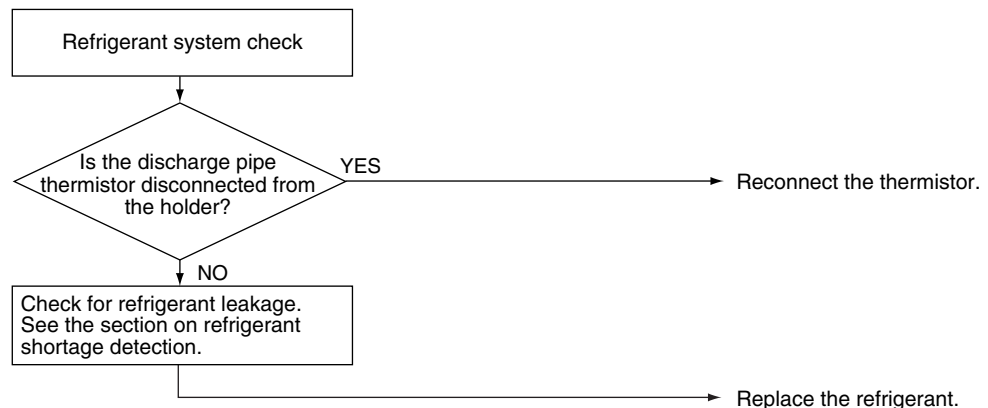

(R18870)

8.8 Inverter Analyzer Check

Check No.15

■ Characteristics

Inverter analyzer: RSUK0917C

If an abnormal stop occurs due to compressor startup failure or overcurrent output when using an inverter unit, it is difficult to judge whether the stop is caused by the compressor failure or some other failure (main PCB, power module, etc.). The inverter analyzer makes it possible to judge the cause of trouble easily and securely. (Connect an inverter analyzer as a quasi-compressor instead of compressor and check the output of the inverter)

■ Operation Method

Step 1

Be sure to turn the power off.

Step 2

Install an inverter analyzer instead of a compressor.

Note:

Make sure the charged voltage of the built-in smoothing electrolytic capacitor drops to 10 VDC or below before carrying out the service work.

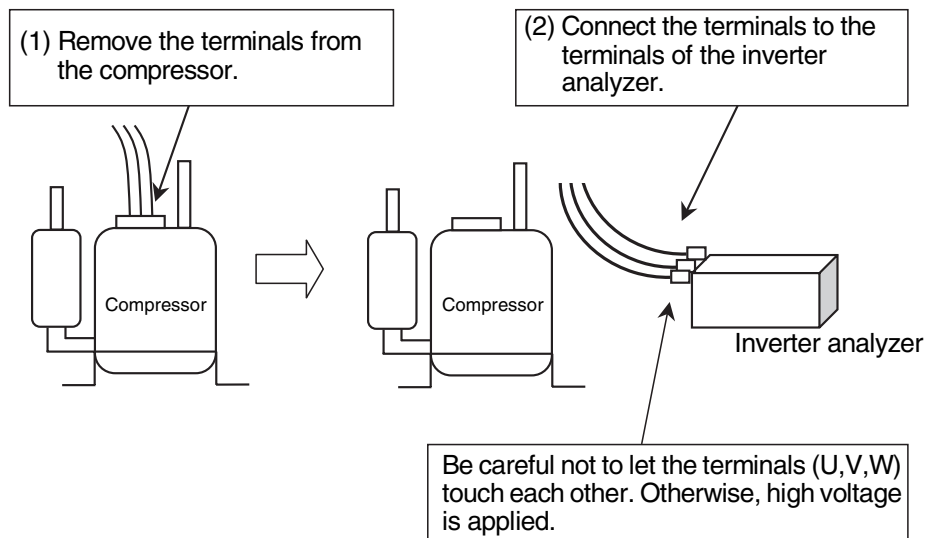

Reference:

If the terminals of the compressor are not FASTON terminals (difficult to remove the wire on the terminals), it is possible to connect wires available on site to the outdoor unit from output side of PCB. (Do not connect them to the compressor at the same time, otherwise it may result in incorrect detection.)

Step 3

Activate the power transistor test operation from the outdoor unit.

Press the forced cooling operation ON/OFF switch for 5 seconds.

(Refer to page 204 for the position.)

→ Power transistor test operation starts.

■ **Diagnose method (Diagnose according to 6 LEDs lighting status.)**

- (1) If all the LEDs are lit uniformly, the compressor is defective.
→ Replace the compressor.
- (2) If the LEDs are not lit uniformly, check the power module.
→ Refer to **Check No.22**.
- (3) If NG in **Check No.22**, replace the power module.
(Replace the main PCB. The power module (IPM1) is united with the main PCB.)
If OK in **Check No.22**, check if there is any solder cracking on the PCB.
- (4) If any solder cracking is found, replace the PCB or repair the soldered section.
If there is no solder cracking, replace the PCB.



Caution

- (1) When the output frequency is low, the LEDs blink slowly. As the output frequency increases, the LEDs blink quicker. (The LEDs look like they are lit.)
- (2) On completion of the inverter analyzer diagnosis, be sure to re-crimp the FASTON terminals. Otherwise, the terminals may be burned due to loosening.

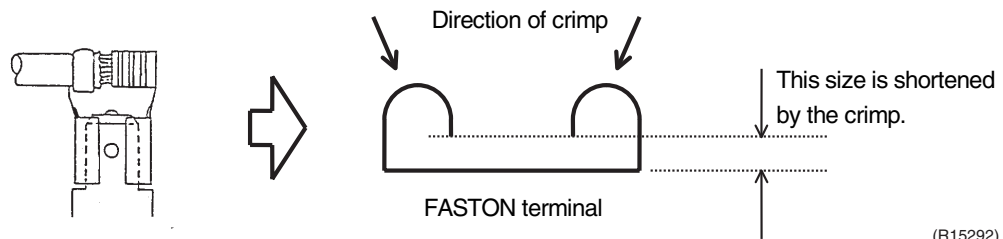

(R15292)

8.9 Rotation Pulse Check on the Outdoor Unit PCB

Check No.16

Outdoor fan motor

Make sure that the voltage of $320 \pm_{50}^{100}$ V is applied.

1. Set operation off and power off. Disconnect the connector S70.
2. Check that the voltage between the pins 4 - 7 is 320 VDC.
3. Check that the control voltage between the pins 4 - 3 is 15 VDC.
4. Check that the rotation command voltage between the pins 4 - 2 is 0 ~ 15 VDC.
5. Keep operation off and power off. Connect the connector S70.
6. Check whether 4 pulses (0 ~ 15 VDC) are input at the pins 4 - 1 when the outdoor fan motor is rotated 1 turn by hand.

When the fuse is melted, check the outdoor fan motor for proper function.

If NG in step 2 → Defective PCB → Replace the outdoor unit PCB (main PCB).

If NG in step 4 → Defective Hall IC → Replace the outdoor fan motor.

If OK in both steps 2 and 4 → Replace the outdoor unit PCB (main PCB).

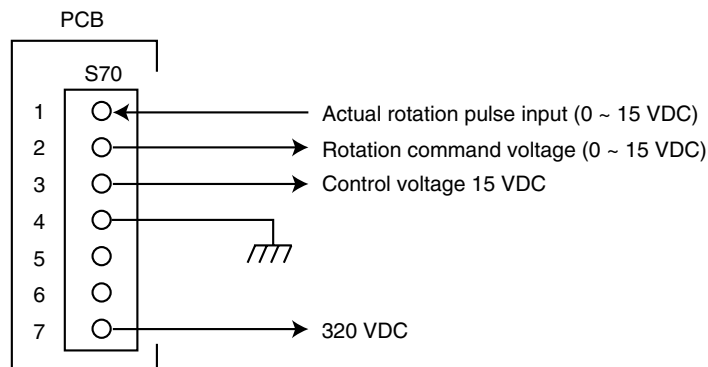

(R21120)

8.10 Installation Condition Check

Check No.17

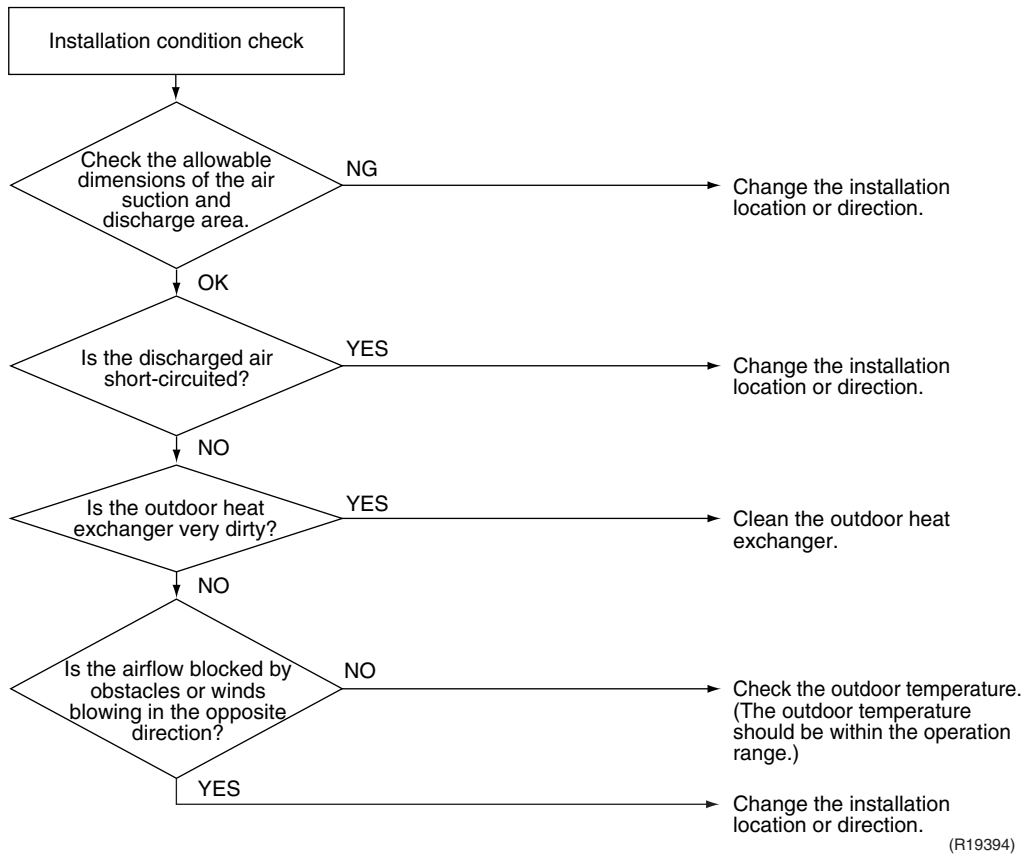

8.11 Discharge Pressure Check

Check No.18

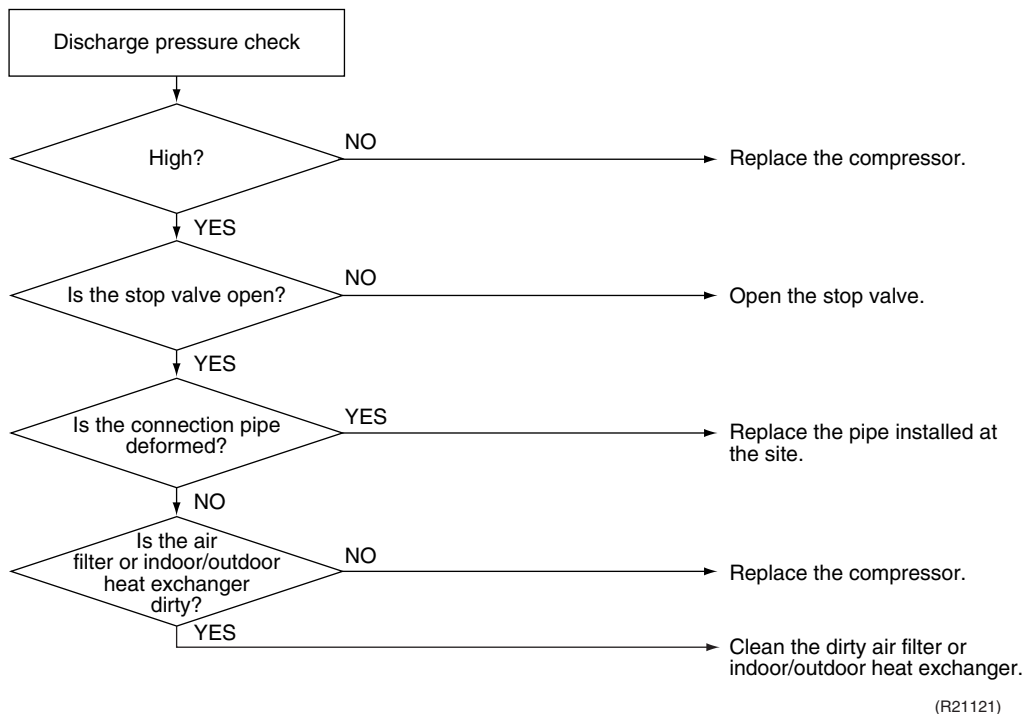

8.12 Outdoor Fan System Check

Check No.19

DC motor

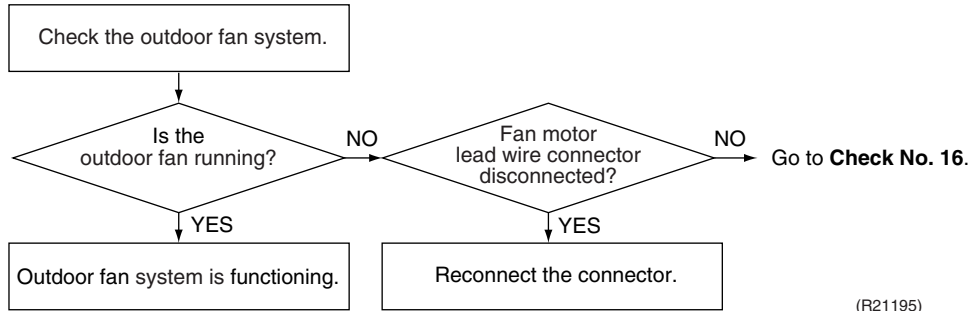

(R21195)

8.13 Main Circuit Short Check

Check No.20

Check to make sure that the voltage between (+) and (-) of the diode bridge (DB1) is about 0 V before checking

- Measure the resistance between the pins of the DB1 referring to the table below.
- If the resistance is ∞ or less than 1 k Ω , short circuit occurs on the main circuit.

Positive terminal (+) of digital multimeter	~ (2, 3)	+ (4)	~ (2, 3)	- (1)
Negative terminal (-) of digital multimeter	+ (4)	~ (2, 3)	- (1)	~ (2, 3)
Resistance is OK.	several k Ω ~ several M Ω			
Resistance is NG.	0 Ω or ∞			

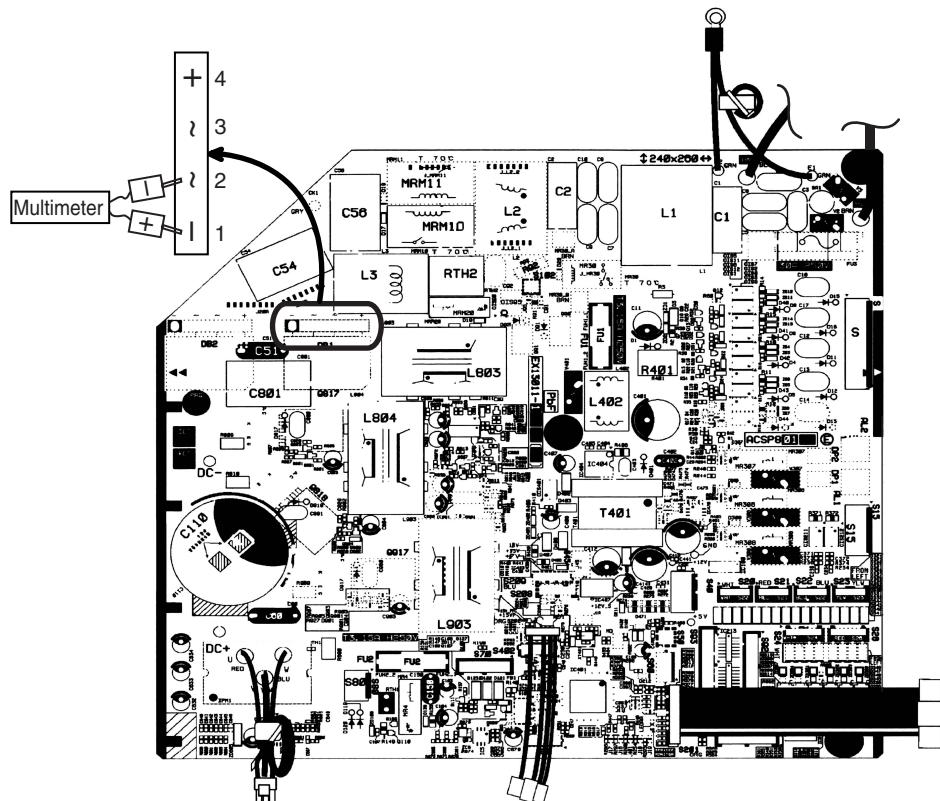

(R24592)

8.14 Capacitor Voltage Check

Check No.21

Before this check, be sure to check the main circuit for short circuit.

With the circuit breaker still on, measure the voltage according to the drawing of the model in question. Be careful never to touch any live parts.

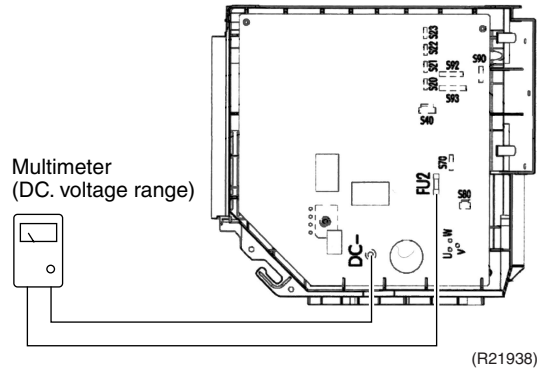

- To prevent an electrical shock, use a multimeter to check that the voltage between FU2 and DC- is 50 V or less.
- The surface of the test points (DC-) may be covered with the coating. Be sure to make firm contact between the multimeter probes and the test points.

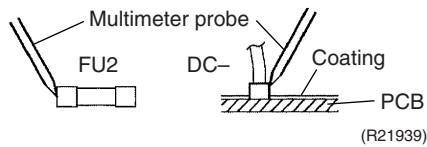

8.15 Power Module Check

Check No.22

Check to make sure that the voltage between (+) and (-) of the power module is about 0 V before checking.

- Disconnect the compressor harness connector from the outdoor unit PCB. To disengage the connector, press the protrusion on the connector.
- Follow the procedure below to measure resistance between the (+) or (-) terminal of the power module and the U, V, or W terminal of the compressor with a multimeter. Evaluate the measurement results referring to the following table.

Positive terminal (+) of digital multimeter	Power module (+)	UVW	Power module (-)	UVW
Negative terminal (-) of digital multimeter	UVW	Power module (+)	UVW	Power module (-)
Resistance is OK.	several kΩ ~ several MΩ			
Resistance is NG.	0 Ω or ∞			

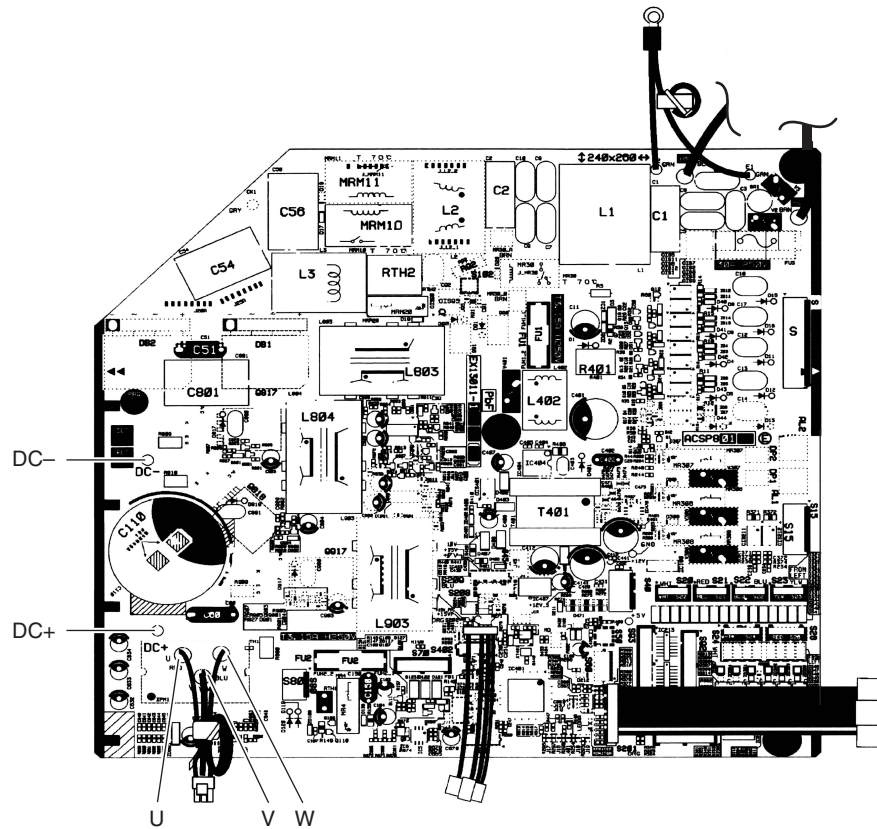

(R24593)

Part 7

Trial Operation and Field Settings

1. Pump Down Operation	203
2. Forced Cooling Operation	204
3. Wiring Error Check Function	205
4. Trial Operation	207
4.1 CTXG, CTXS, FTXS, CDXS, FDXS, FVXS Series	207
4.2 FFQ Series	209
5. Field Settings	212
5.1 Outdoor Unit	212
5.2 CTXG, CTXS, FTXS, CDXS, FDXS, FVXS Series	214
5.3 FFQ Series	219
6. Silicone Grease on Power Transistor/Diode Bridge	227

1. Pump Down Operation

Pump Down Operation

In order to protect the environment, be sure to conduct pump down operation when relocating or disposing the unit.

1. Remove the valve caps from the liquid stop valve and the gas stop valve.
2. Carry out forced cooling operation.
3. After 5 ~ 10 minutes, close the liquid stop valve with a hexagonal wrench.
4. After 2 ~ 3 minutes, close the gas stop valve and stop the forced cooling operation.

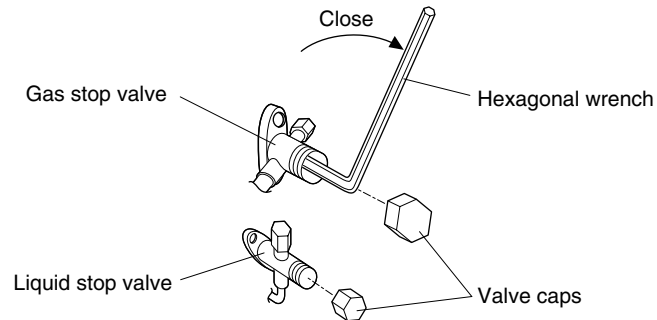

(R14566)

2. Forced Cooling Operation

Outline

The forced cooling operation is allowed when both the following conditions are met.

1. The outdoor unit is not abnormal and not in the 3-minute standby mode.
2. The outdoor unit is not operating.

Protection functions have priority over all other functions during forced cooling operation.

Procedure

1. Turn off the power.
2. Remove the service lid (2 screws).
3. Remove the service PC-board switch cover (1 screw).
4. Switch SW5 and SW6 to off.
5. Turn the operation mode switch (SW2) to COOL.
6. Screw the service PC-board switch cover back on (1 screw).
7. Turn on the power.
8. Push the forced operation switch (SW1) above the service PC-board cover. (The operation will start.)
 - Forced cooling operation will stop automatically after about 10 minutes.
 - To stop the operation, push the forced operation switch (SW1).

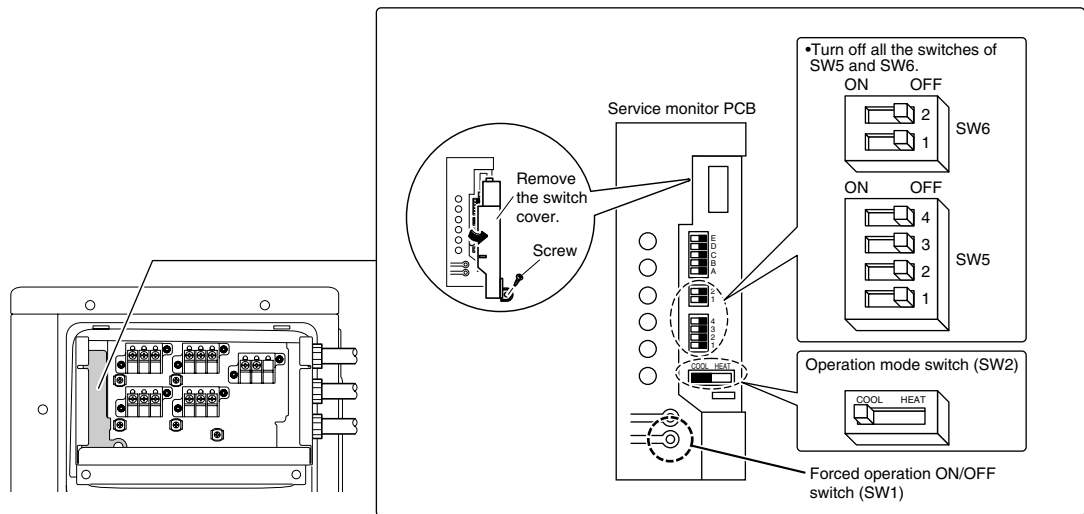

(R24623)

3. Wiring Error Check Function

Outline

Wiring error check function is designed for the microcomputer to correct wiring errors itself. If local wiring is unclear in the case of buried piping, for example, just press the wiring error check switch on the outdoor unit. Even if the connections for Room A and Room B are confused, the system may run without a hassle. Note that this check function does not work in the following cases.

- For 3-minute standby period after the power is turned on or after the compressor has stopped.
 - When the outdoor temperature is below 5°C (41°F).
 - If the indoor unit is in trouble (also in case of all-room transmission failure).
- When the piping and wiring are perfect, there is no need to use this function.

Procedure

1. Press the wiring error check switch (SW3) on the service monitor PCB of the outdoor unit, and the wiring error check function is activated.
2. In about 15 ~ 20 minutes, the check finishes automatically.
3. When the check is over, the service monitor LED indicators start blinking.

LED	1	2	3	4	5	Judgment
Status	Blinking one after another					Self-correction completed
	All blinking					Self-correction impossible
	Any of the LEDs stay on.					Emergency stop

- Self-correction completed...The LED indicators 1 ~ 2 (18 class), 1 ~ 3 (24 class), or 1 ~ 4 (36 class) blink one after another.
- Self-correction impossible...The LED indicators blink all at the same time.
 - * Transmission failure occurs at any of the indoor units.
 - * The indoor heat exchanger thermistor is disconnected.
 - * An indoor unit is in trouble (if a trouble occurs during the wiring error checking).
- Emergency stop...If any of the LED indicators stay on, follow the diagnostic procedure.

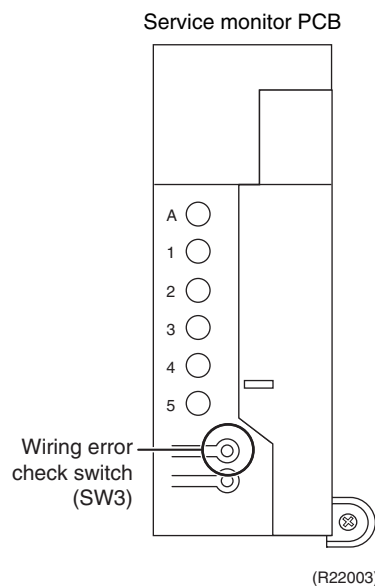

Details

- Refrigerant flows from Port A and on. The indoor heat exchanger temperatures are detected one by one to check up the matching between the piping and wiring.
- With this function on, freezing (crackling) noise may be heard from the indoor unit. This is not a problem. (This is because the indoor heat exchanger temperature is made to drop below 0°C (32°F) in order to increase the detection accuracy.)
- The indoor fan turns on or off during wiring checking.
- The results can be checked by looking at the service monitor LED indicators, when the wiring error checking is over. The LED indicators stop blinking when the ordinary operation starts.
 LED1...Room A wiring, LED2...Room B wiring
 1st blinking LED...Port A piping, 2nd blinking LED...Port B piping
 The 1st blinking LED means the room that is connected with Port A. The 2nd blinking LED means the one connected with Port B.

Ex: Suppose the LED indicators are blinking as follows.

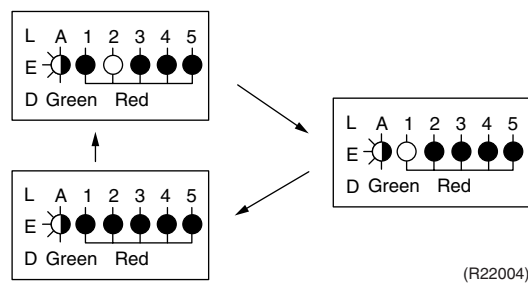

The above means that Port A is connected with Room B, and Port B with Room A (or self-corrected this way.)

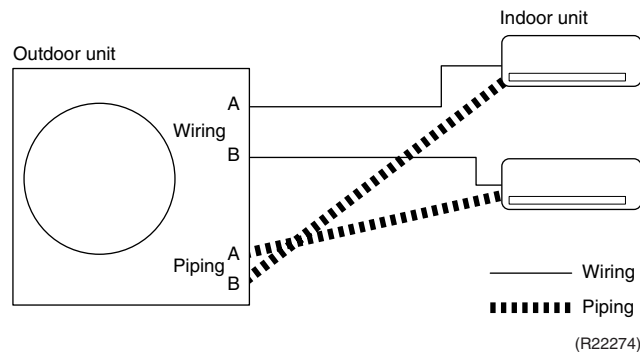
**Notes:**

1. Wrongly connected liquid and gas pipes cannot be self-corrected. Be sure to make the liquid pipe and the gas pipe in pairs.
2. To cancel the wiring error check procedure halfway, press the wiring error check switch again. In this case, the memory of the microcomputer returns to its initial status (Room A wiring → Port A piping, Room B wiring → Port B piping).
3. When replacing the outdoor unit PCB, be sure to use this function.
4. Make the priority room setting after wiring error check. If you set the priority room before wiring error check, the prioritized room may be changed after self-correction.

4. Trial Operation

4.1 CTXG, CTXS, FTXS, CDXS, FDXS, FVXS Series

Outline

Carry out the trial operation in accordance with the operation manual to ensure that all functions and parts, such as flap movement, are working properly.

Trial operation should be carried out in either cooling or heating operation.

Procedure

1. Measure the power supply voltage and make sure that it falls within the specified range.
2. In cooling operation, select the lowest programmable temperature (18°C (64°F)); in heating operation, select the highest programmable temperature (30°C (86°F)).
 - ♦ Trial operation may be disabled in either operation mode depending on the room temperature.
 - ♦ After trial operation is complete, set the temperature to a normal level (26 ~ 28°C (78 ~ 82°F) in cooling, 20 ~ 24°C (68 ~ 75°F) in heating).
 - ♦ For protection, the system does not start for 3 minutes after it is turned off.

ARC452 Series

- (1) Press **ON/OFF** button to turn on the system.
- (2) Press both of **TEMP** buttons and **MODE** button at the same time.
- (3) Press **MODE** button twice.
(? appears on the display to indicate that trial operation is selected.)
- (4) Press **MODE** button and select the operation mode.
- (5) Trial operation terminates in about 30 minutes and switches into normal mode. To quit trial operation, press **ON/OFF** button.

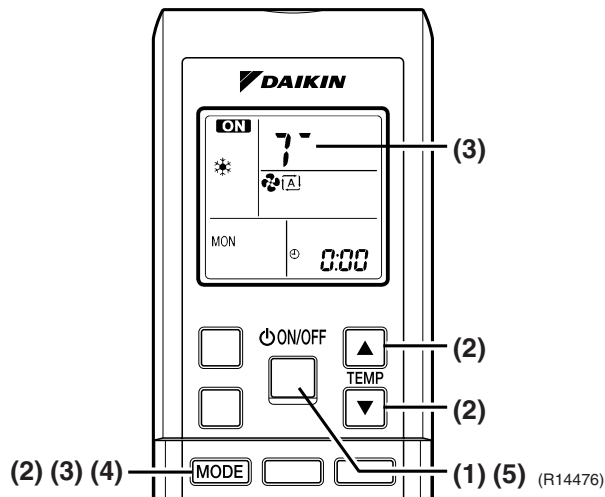

ARC466 Series

- (1) Press **On/Off** button to turn on the system.
- (2) Press the center of **Temp** button and **Mode** button at the same time.
- (3) Select 7° (trial operation) with **Temp ▲** or **Temp ▼** button.
- (4) Press **Mode** button to start the trial operation.
- (5) Press **Mode** button and select operation mode.
- (6) Trial operation terminates in about 30 minutes and switches into normal mode. To quit trial operation, press **On/Off** button.

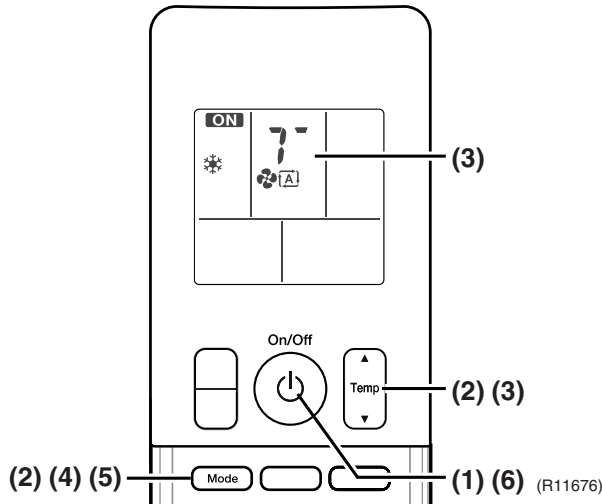

Test Items

Test Items	Symptom
Indoor and outdoor units are installed properly on solid bases.	Fall, vibration, noise
No refrigerant gas leaks.	Incomplete cooling/heating function
Refrigerant gas and liquid pipes and indoor drain hose extension are thermally insulated.	Water leakage
Draining line is properly installed.	Water leakage
System is properly grounded.	Electrical leakage
The specified wires are used for inter-unit wire connections.	Inoperative or burn damage
Indoor or outdoor unit's air inlet or outlet has clear path of air. Stop valves are opened.	Incomplete cooling/heating function
Indoor unit properly receives remote control commands.	Inoperative
The heat pump or cooling only mode is selectable with the DIP switch of the remote controller	Remote controller malfunctioning



Note: The test items above are for CTXS, FTXS series as representative. Refer to the installation manual for the other series.

4.2 FFQ Series

Outline

- Make sure to install the decoration panel before carrying out trial operation if the wireless remote controller is used.
- Trial operation should be carried out in either cooling or heating operation.
 1. Measure the supply voltage and make sure that it is within the specified range.
 2. In cooling operation, select the lowest programmable temperature; in heating operation, select the highest programmable temperature.
 3. Carry out the trial operation following the instructions in the operation manual to ensure that all functions and parts, such as the movement of the flaps, are working properly.
 - ◆ To protect the air conditioner, restart operation is disabled for 3 minutes after the system has been turned off.
 4. After trial operation is complete, set the temperature to a normal level (78°F to 82°F (26°C to 28°C) in cooling operation, 68°F to 75°F (20°C to 24°C) in heating operation).



Caution

When performing field settings or trial operation without attaching the decoration panel, do not touch the drain pump. This may cause electric shock.
After finishing the construction of refrigerant piping, drain piping, and electric wiring, conduct trial operation accordingly to protect the unit.

Procedure



When operating the air conditioner in cooling operation in winter, or heating operation in summer, set it to the trial operation mode using the following method.

■ **With Wired Remote Controller (BRC1E73)**

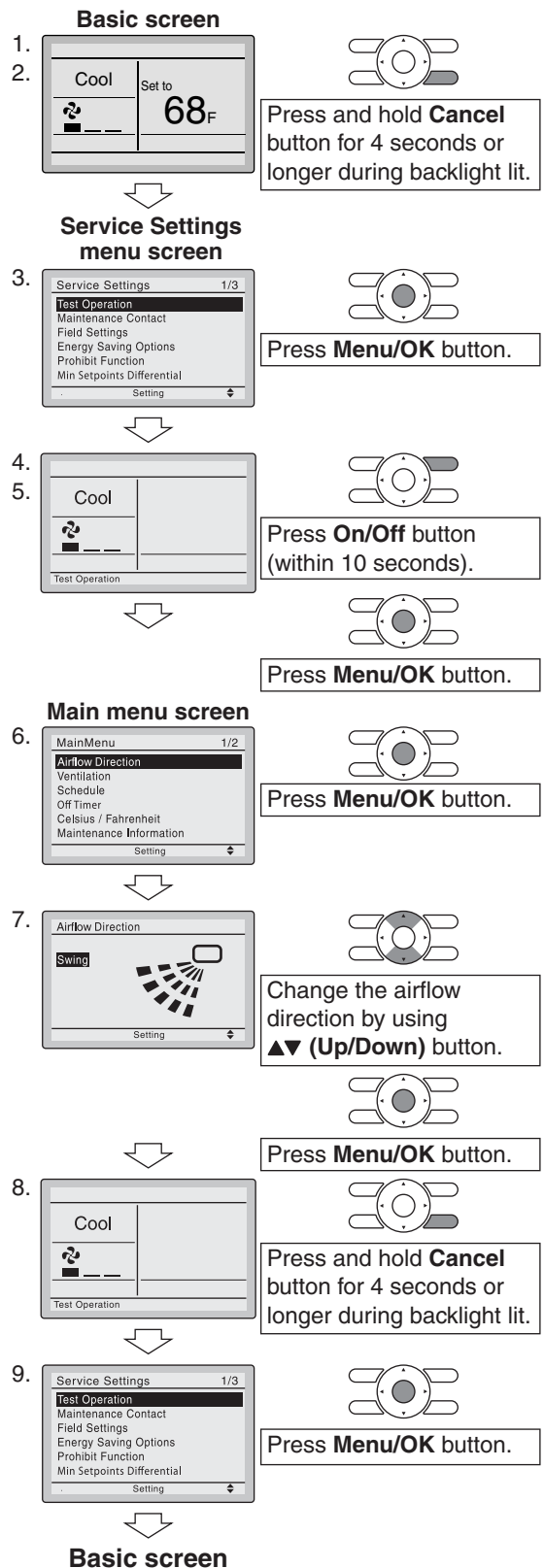
1. Set to COOL or HEAT operation using the remote controller.
2. Press and hold **Cancel** button for 4 seconds or longer. Service settings menu is displayed.
3. Select **Test Operation** in the service settings menu, and press **Menu/OK** button. Basic screen returns and “Test Operation” is displayed at the bottom.
4. Press **On/Off** button within 10 seconds, and the test operation starts.
Monitor the operation of the indoor unit for a minimum of 10 minutes. During test operation, the indoor unit will continue to cool/heat regardless of the temperature setpoint and room temperature.
 - ◆ In the case of above-mentioned procedures 3 and 4 in reverse order, test operation can start as well.
5. Press **Menu/OK** button in the basic screen. Main menu is displayed.
6. Select **Airflow Direction** in the main menu and press **Menu/OK** button. Check that airflow direction is actuated according to the setting. For operation of airflow direction setting, see the operation manual.
7. After the operation of airflow direction is confirmed, press **Menu/OK** button. Basic screen returns.
8. Press and hold **Cancel** button for 4 seconds or longer in the basic screen. Service settings menu is displayed.
9. Select **Test Operation** in the service settings menu, and press **Menu/OK** button. Basic screen returns and normal operation is conducted.
 - ◆ Test operation will stop automatically after 15 ~ 30 minutes. To stop the operation, press **On/Off** button.
10. If the decoration panel has not been installed, turn off the power after the test operation.



■ With Wireless Remote Controller Kit (BRC082A41W, BRC082A42W(S))

1. Press  button and select the COOL or HEAT operation.
2. Press  button twice. "TEST" is displayed.
3. Press  button within 10 seconds, and the test operation starts.

Monitor the operation of the indoor unit for a minimum of 10 minutes. During test operation, the indoor unit will continue to cool/heat regardless of the temperature setpoint and room temperature.

- ◆ In the case of above-mentioned procedures (1) and (2) in reverse order, test operation can start as well.
- ◆ Test operation will stop automatically after 15 ~ 30 minutes. To stop the operation, press  button.
- ◆ Some of the functions cannot be used in the test operation mode.

Test Items

Test items	Symptom
Indoor and outdoor units are installed securely.	Fall, vibration, noise
Is the outdoor unit fully installed?	No operation or burn damage
No refrigerant gas leaks.	Incomplete cooling/heating function
Refrigerant gas and liquid pipes and indoor drain hose extension are thermally insulated.	Water leakage
Draining line is properly installed.	Water leakage
Does the power supply voltage correspond to that shown on the name plate?	No operation or burn damage
Only specified wires are used for all wiring, and all wires are connected correctly.	No operation or burn damage
System is properly grounded.	Electrical leakage
Is wiring size according to specifications?	No operation or burn damage
Is something blocking the air outlet or inlet of either the indoor or outdoor units?	Incomplete cooling/heating function
Are refrigerant piping length and additional refrigerant charge noted down?	The refrigerant charge in the system is not clear
Pipes and wires are connected to the corresponding connection ports/terminal blocks for the connected unit.	No cooling/heating
Stop valves are opened.	Incomplete cooling/heating function
Check that the connector of the lead wires of the decoration panel is connected securely.	Louvers do not move
Indoor unit properly receives wireless remote control commands.	No operation

5. Field Settings

5.1 Outdoor Unit

5.1.1 Priority Room Setting

Outline

1. Operation mode
The operation mode of the prioritized room takes precedence. For example, when the prioritized indoor unit starts cooling operation, the other indoor units which have been in heating operation enter the standby mode. Heating operation will resume if the prioritized indoor unit stops cooling operation.
2. POWERFUL operation
The electronic expansion valves are controlled to provide more capacity to the prioritized room and the capacities for the other indoor units will be slightly reduced.
3. OUTDOOR UNIT QUIET operation
When the OUTDOOR UNIT QUIET operation is selected in the prioritized room, the outdoor unit runs quietly.
(Without priority room setting, OUTDOOR UNIT QUIET operation starts only when the function is set for all the operating indoor units.)

Procedure

1. Turn the circuit breaker off before changing the setting.
2. Turn on the one of the switches of the SW4 on the service monitor PCB.
Only one room can be set as the priority room.
3. Turn the power on.

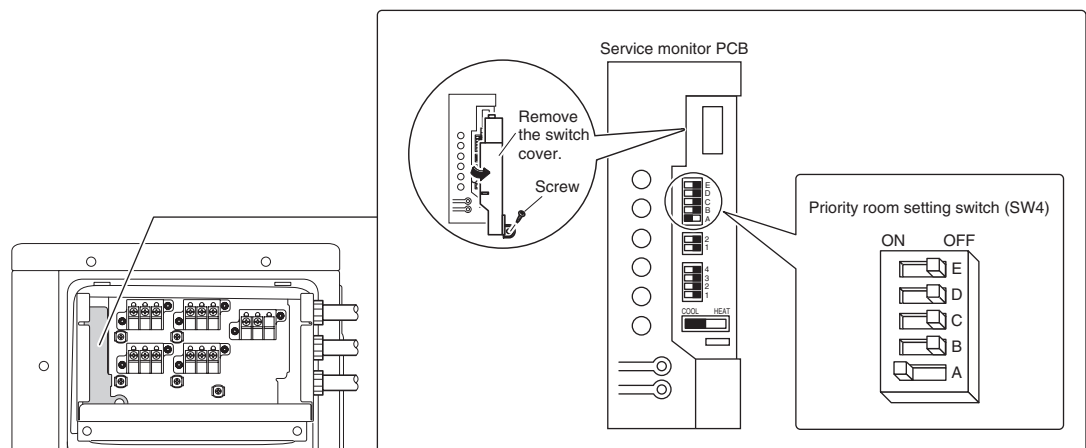

(R22006)

5.1.2 COOL/HEAT Mode Lock

Use the S15 connector to set the unit to cooling only or heating only.
 Setting to heating only (H): Short-circuit the pins 1 and 3 of the connector S15.
 Setting to cooling only (C): Short-circuit the pins 3 and 5 of the connector S15.
 The following specifications apply to the connector housing and pins.

- JST products:
 Housing: VHR-5N
 Pin: SVH-21T-1, 1

Note that forced operation is also possible in cooling/heating mode.

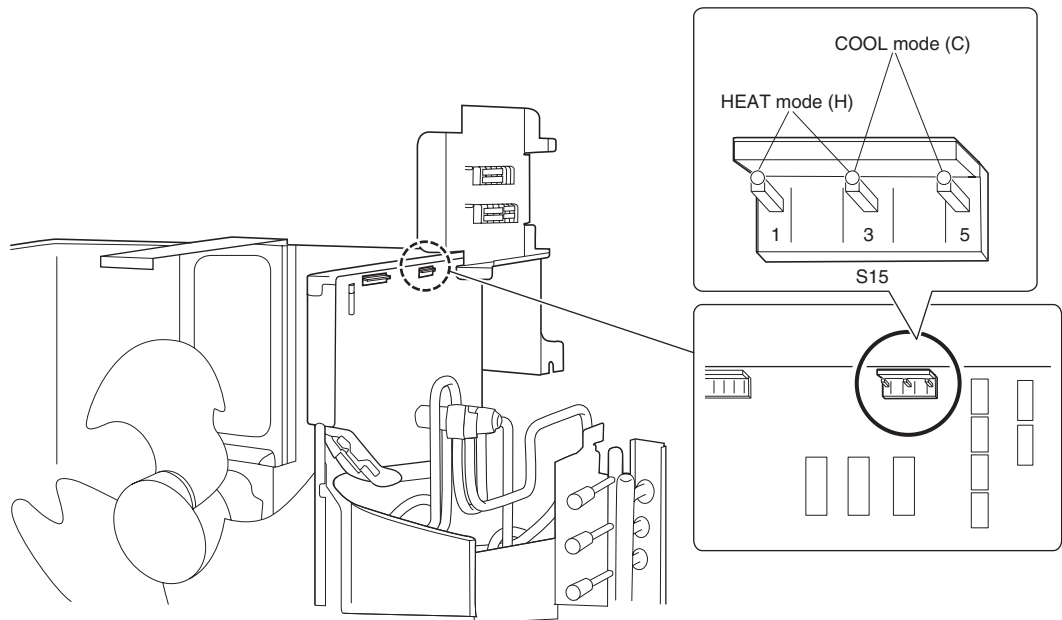

(R22007)

5.1.3 NIGHT QUIET Mode

Outline

If NIGHT QUIET mode is to be used, initial settings must be made when the unit is installed. Explain the function of NIGHT QUIET mode, as described below, to the customer, and confirm whether or not the customer wants to use NIGHT QUIET mode. NIGHT QUIET mode function reduces operating noise of the outdoor unit at nighttime. This function is useful if the customer is worried about the effects of the operating noise on the neighbors. However, if NIGHT QUIET mode is running, cooling capacity is reduced.

Procedure

Turn on the SW6-1 on the service monitor PCB of the outdoor unit.

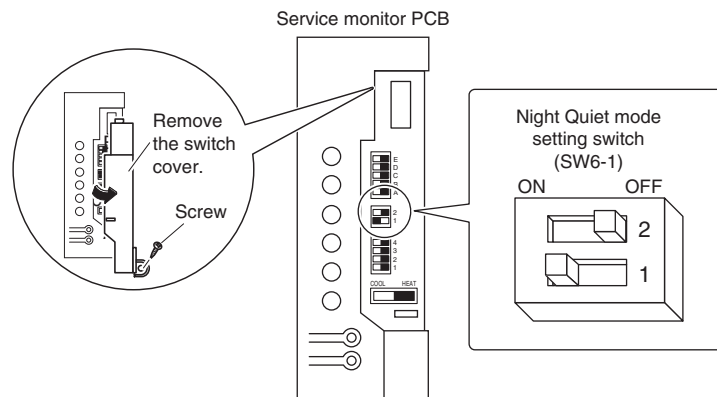

(R22008)

5.2 CTXG, CTXS, FTXS, CDXS, FDXS, FVXS Series

5.2.1 Model Type Setting

ARC452A21, ARC452A23

- The remote controller is common to the heat pump model and cooling only model.
- Make sure the DIP switch is set to the left side. The heating operation will not be available when the DIP switch is set to the right side.

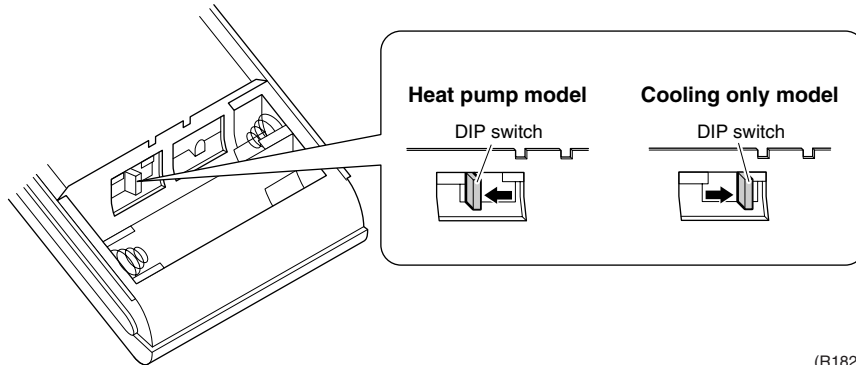

(R18201)

ARC466A21, ARC466A36

- The remote controller is common to the heat pump model and cooling only model.

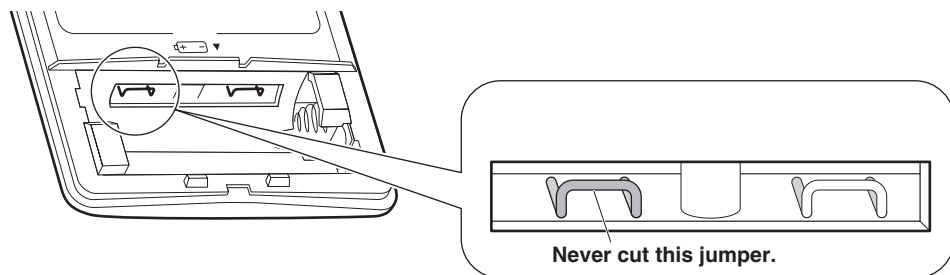

(R23955)



Caution

Replace the remote controller if you cut the jumper on the left side.

The heating operation will not be available when the jumper on the left side is cut.

5.2.2 Temperature Display Switch

You can select Fahrenheit or Celsius for temperature display.

ARC452A21, ARC452A23

- Press **TEMP▲** and **TEMP▼** buttons at the same time for 5 seconds to change the unit of temperature display.

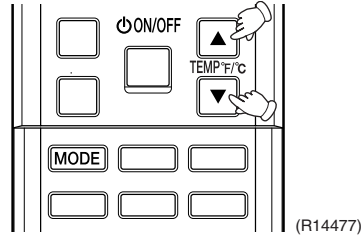

ARC466A21, ARC466A36

- Press the upper side of **Temp** button and **On** button at the same time for 5 seconds to change the unit of temperature display.

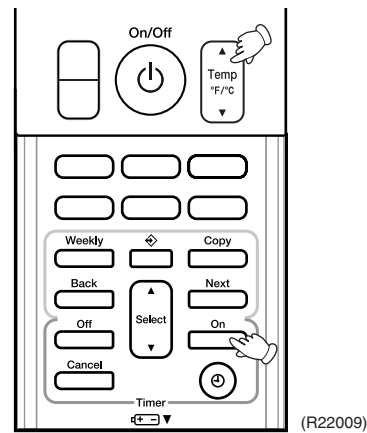

5.2.3 When 2 Units are Installed in 1 Room

Outline

When 2 indoor units are installed in 1 room, 1 of the 2 indoor units and the corresponding wireless remote controller can be set for different address.
Both the indoor unit PCB and the wireless remote controller need alteration.

The method of address setting varies depending on the type of indoor unit and the series of wired remote controller. Refer to the following pages for the appropriate indoor unit and wireless remote controller.

CTXG, CTXS, FTXS Series

- (1) Remove the front grille.
- (2) Remove the electrical box.
- (3) Remove the shield plate of the electrical box.
- (4) Cut the address setting jumper JA on the PCB.

CTXG Series

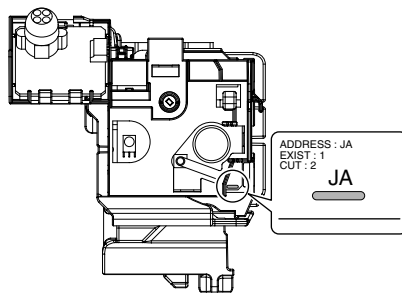

(Bottom of electrical box)
(R21128)

CTXS07LVJU, FTXS09/12LVJU

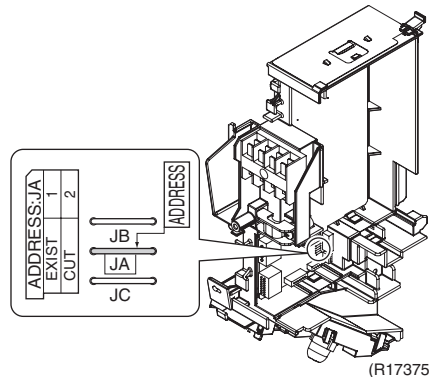

(R17375)

FTXS15/18LVJU

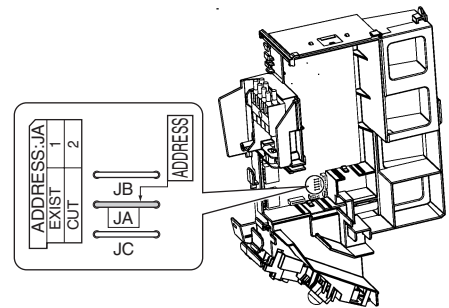

(R9665)



Caution

Replace the PCB if you accidentally cut a wrong jumper.

Jumpers are necessary for electronic circuit. Improper operation may occur if you cut any of them.

CDXS, FDXS Series

- Cut the jumper JA on PCB.

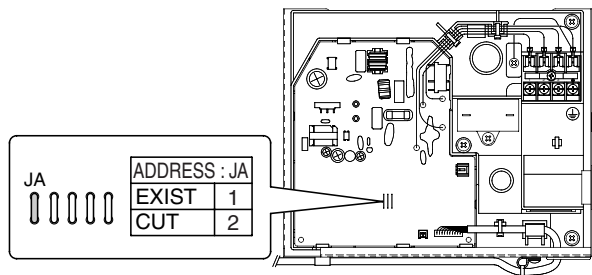

(R22010)



Caution

Replace the PCB if you accidentally cut a wrong jumper.

Jumpers are necessary for electronic circuit. Improper operation may occur if you cut any of them.

FVXS Series

- (1) Remove the front grille.
- (2) Lift the sensor PCB fixing plate and remove the front shield plate.
- (3) Disconnect the connectors S1, S41, S42.
- (4) Remove the electric box (1 screw).
- (5) Pull out the indoor heat exchanger thermistor.
- (6) Remove the shield plate (8 tabs).
- (7) Cut the address setting jumper JA on the indoor unit PCB.

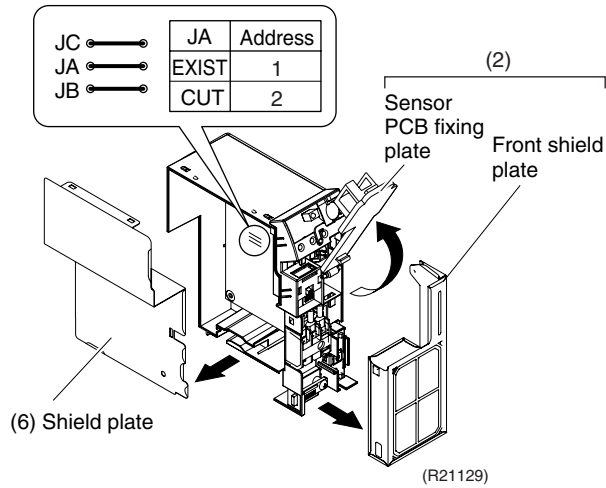
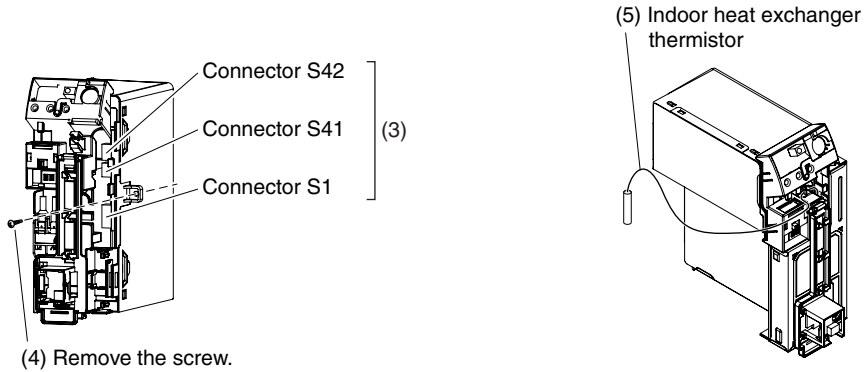

Caution

Replace the PCB if you accidentally cut a wrong jumper.

Jumpers are necessary for electronic circuit. Improper operation may occur if you cut any of them.

Wireless Remote Controller

- (1) Remove the cover and take it off.
- (2) Cut the address setting jumper.

ARC452 series

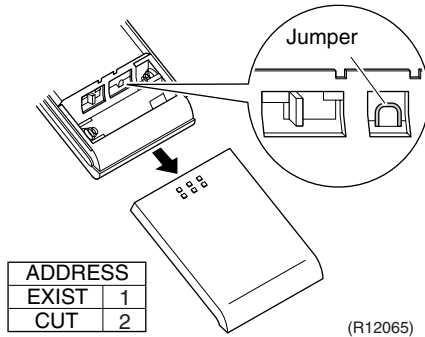

ARC466 series

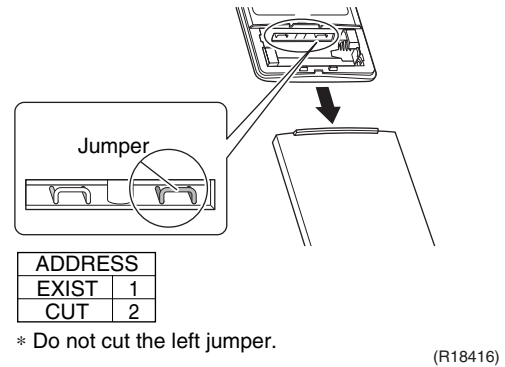

Caution

Replace the remote controller if you accidentally cut a wrong jumper.

Jumpers are necessary for electronic circuit. Improper operation may occur if you cut any of them.

5.2.4 Jumper Settings

CTXG, CTXS, FTXS, CDXS, FDXS, FVXS series

Jumper (on indoor unit PCB)	Function	When connected (factory set)	When cut
JB	Fan speed setting when compressor stops for thermostat OFF. (effective only at cooling operation)	Fan speed setting; Remote controller setting	The fan stops.
JC	Power failure recovery function	Auto-restart	The unit does not resume operation after recovering from a power failure. Timer settings are cleared.

FVXS series only

Switch (on indoor unit PCB)	Function	OFF (factory setting)	ON
SW2-4	Upward airflow limit setting	Exposed or half embedded installation	Set the switch to ON position when you install the indoor unit embedded in the wall to avoid condensation.



For the location of the jumper, refer to the following pages.

CTXG09/12/18QVJUW(S): page 21

CTXS07LVJU, FTXS09/12LVJU: page 23

FTXS15/18/24LVJU: page 25

FDXS09/12LVJU, CDXS15/18/24LVJU: page 27

FVXS09/12/15/18NVJU: page 29

5.3 FFQ Series

5.3.1 How to Change the Field Settings

Outline

If optional accessories are mounted on the indoor unit, the indoor unit setting may have to be changed. Refer to the instruction manual for each optional accessory.



Note: When using 2 remote controllers for 1 indoor unit, change the field settings from MAIN remote controller. Note that the field settings can not be set from SUB remote controller.

Wired Remote Controller (BRC1E73)

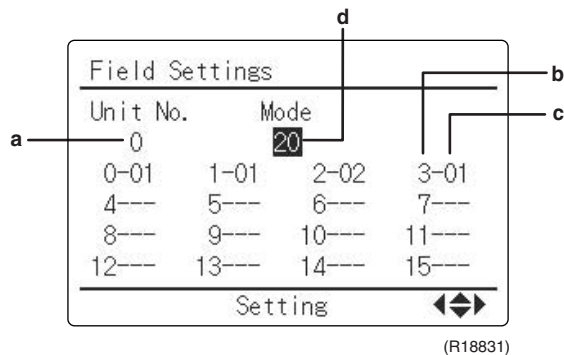

- a Unit No.
- b First code No.
- c Second code No.
- d Mode

1. Press and hold **Cancel** button for 4 seconds or longer. Service settings menu is displayed.

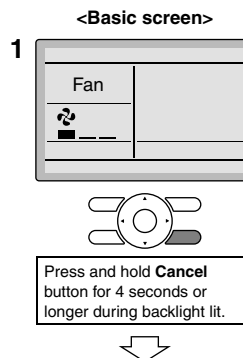

2. Select **Field Settings** in the Service Settings menu, and press **Menu/OK** button. Field settings screen is displayed.

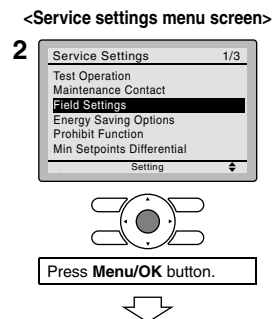

3. Highlight the mode, and select desired "Mode No." by using ▲ ▼ (Up/Down) button.
4. In the case of setting per indoor unit during group control (When Mode No. such as **20**, **22**, **23**, **25** are selected), highlight the unit No. and select "Indoor unit No." to be set by using ▲ ▼ (Up/Down) button. (In the case of group setting, this operation is not needed.)

[In the case of individual setting per indoor unit, current settings are displayed. And, SECOND CODE NO. " - " means no function.]

5. Highlight SECOND CODE NO. of the FIRST CODE NO. to be changed, and select desired "SECOND CODE NO." by using ▲ ▼ (Up/Down) button. Multiple identical mode number settings are available.

[In the case of setting for all indoor units in the remote control group, available SECOND CODE NO. is displayed as "*" which means it can be changed. When SECOND CODE NO. is displayed as " - ", there is no function.]

<Service settings screen>

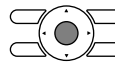
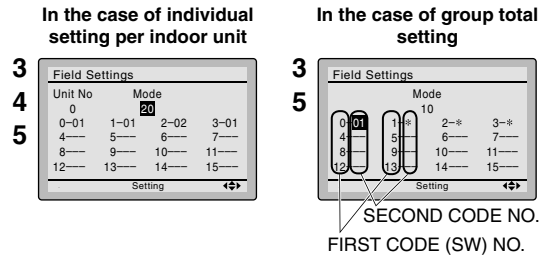

Press Menu/OK button.

6. Press **Menu/OK** button. Setting confirmation screen is displayed.
7. Select **Yes** and press **Menu/OK** button. Setting details are determined and field settings screen returns.
8. In the case of multiple setting changes, repeat 3 to 7.
9. After all setting changes are completed, press **Cancel** button twice.
10. Backlight goes out, and **[Checking the connection. Please stand by.]** is displayed for initialization. After the initialization, the basic screen returns.



<Setting confirmation screen>

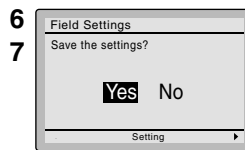

Press Menu/OK button.



Setting confirmation



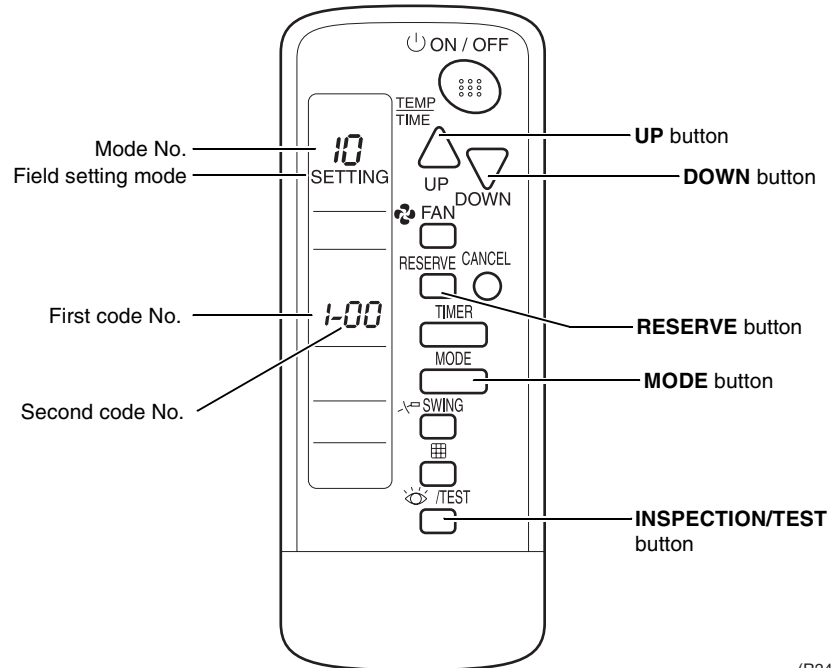

**Wireless Remote
Controller Kit
(BRC082A41W,
BRC082A42W(S))**



(R24061)

To set the field settings, you have to change:

- Mode No.
- First code No.
- Second code No.

1. When in normal mode, hold down the /TEST button for at least 4 seconds to enter the Field Set mode.
2. Select the desired Mode No. with the **MODE** button.
3. Press the  button and select the First code No.
4. Press the  button and select the Second code No.
5. Press the **RESERVE** button to confirm the settings.
6. Press the /TEST button to quit the Field Set mode and to return to normal display again.

5.3.2 Overview of the Field Settings

Mode No.	First Code No.	Description of setting		Second Code No.					
				01	02	03	04	05	06
10 (20)	0	Filter cleaning sign interval	Longlife filter	Light Approx. 2,500 hrs.	Heavy Approx. 1,250 hrs.	—	—	—	—
	2	Remote controller thermistor		Enabled	Disabled	—	—	—	—
	3	Filter cleaning sign		Display	No display	—	—	—	—
12 (22)	0	Optional accessories output selection (field selection of output for adaptor for wiring)		Compressor	—	Operation output	Error output	Outdoor air intake	Presence sensor
13 (23)	0	High air outlet velocity (for high ceiling applications)		≤ 2.7 m (≤ 8-7/8 ft)	2.7 ~ 3.0 m (8-7/8-9-13/16 ft)	3.0 ~ 3.5 m (9-13/16-11-1/2 ft)	—	—	—
	1	Selection of airflow direction (setting for when a blocking pad kit has been installed)		4-way flow	3-way flow	2-way flow	—	—	—
	4	Airflow direction range setting		Upper	Normal	Lower	—	—	—
15 (25)	3	Drain pump operation with humidifying		Not equipped	Equipped	—	—	—	—

■ : factory setting



Note: Any function that is not available on the indoor unit is not displayed.

5.3.3 MAIN/SUB Setting when Using 2 Wired Remote Controllers

Outline

The MAIN/SUB setting is necessary when 1 indoor unit is controlled by 2 remote controllers. When you use 2 remote controllers, set one to MAIN and the other to SUB.

Details

1. The following message is displayed after power-on.

Checking the connection.

Please stand by.

When the above message is displayed, the backlight will not be ON.

[In the case that 1 indoor unit is controlled by 2 remote controllers:]

Make sure to set the sub remote controller when the above message is displayed.

Hold **Mode** button for 4 seconds or longer to set.

When the display is changed from “Main RC” to “Sub RC” the setting is completed.

2. Basic screen is displayed.

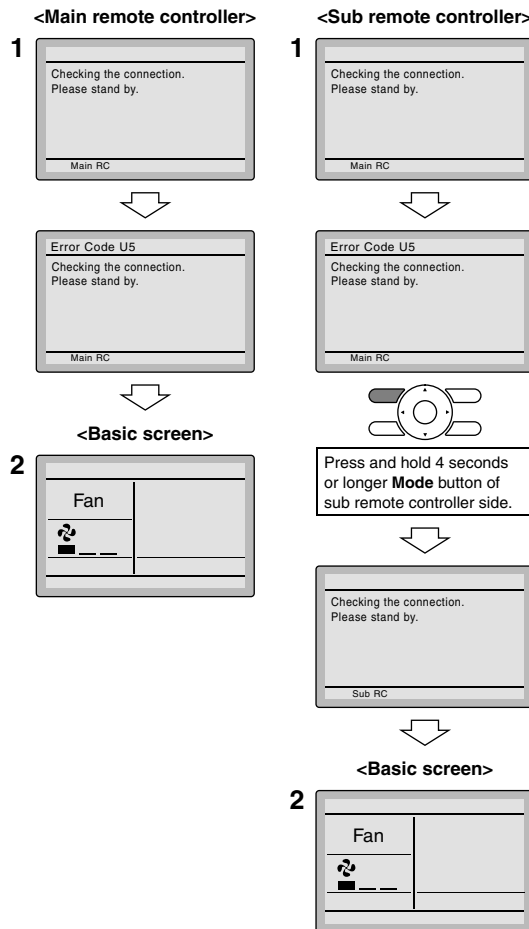

5.3.4 Address and MAIN/SUB Setting for Wireless Remote Controller



Outline

- If setting multiple wireless remote controllers to operate in one room, perform address setting for the receiver and the wireless remote controller.
- If using both a wired remote controller and a wireless remote controller with 1 indoor unit, change the MAIN/SUB switch of the transmitter board.

Transmitter Board

Wireless address switch

Set the wireless address setting switch (SS2) on the transmitter board according to the table below.

Unit No.	No.1	No.2	No.3
Wireless address switch (SS2)	 (S1935)	 (S1936)	 (S1937)

MAIN/SUB switch

When using both a wired and a wireless remote controller for 1 indoor unit, the wired controller should be set to MAIN. Therefore, set the MAIN/SUB switch (SS1) of the transmitter board to SUB.

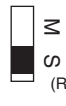
	MAIN	SUB
MAIN/SUB switch (SS1)	 (R24062)	 (R24063)

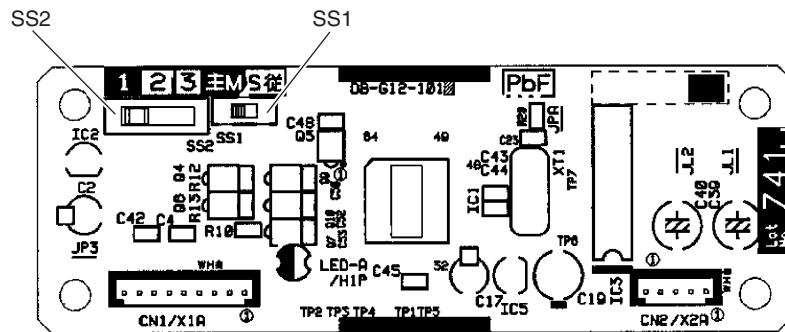

(R24374)

Wireless Remote Controller Address

Factory set is 1. Change the wireless remote controller address setting by the following steps, if necessary.

1. Hold down button and /TEST button at the same time for at least 4 seconds to enter the field setting mode. (SETTING is indicated on the display).
2. Press FAN button and select display setting (A or B). Each time the button is pressed, the display switches between A and B.
3. Press UP button and DOWN button to set the address.

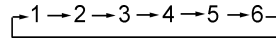

Address can be set from 1 ~ 6, but set it to 1 ~ 3 and to same address as the transmitter board. (The transmitter board does not work with address 4 ~ 6.)

4. Press **RESERVE** button to confirm the setting.
5. Hold down /TEST button to quit the field setting mode and return to the normal display.

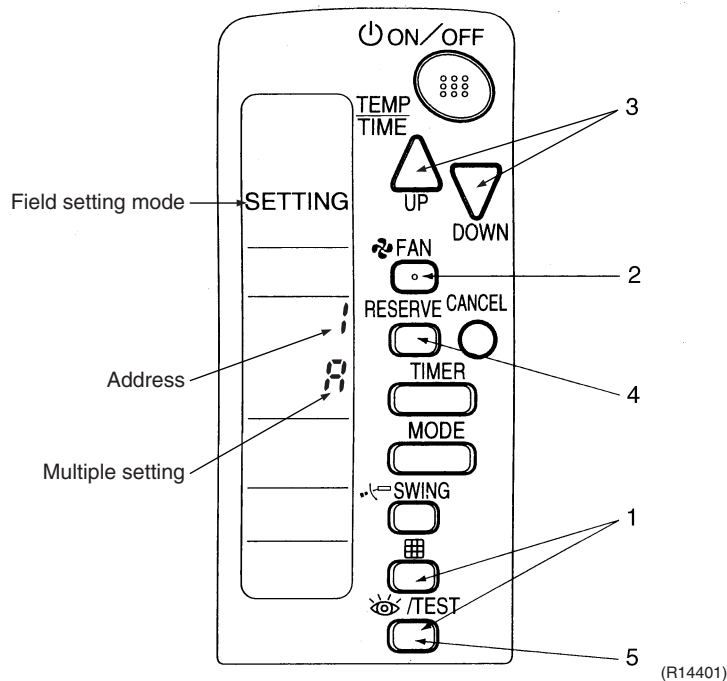

Display Settings
A or B

When the indoor unit is controlled by an outside controller (central remote controller, etc.), the indoor unit sometimes does not respond to ON/OFF command or temperature setting command from the wireless remote controller. Check what setting the customer needs and make the multiple setting as shown below.

Display setting	Remote controller display	Result of the display setting in case the target indoor unit is simultaneously being controlled by more than 1 device
A: standard	All operational items are permanently displayed.	In the operation mode changeover, temperature setting or the like are carried out from the wireless remote controller, the indoor unit rejects the instruction. (Signal receiving sound, 1 long beep or 3 short beeps) As a result, a display discrepancy between the operation state of the indoor unit and the indication on the wireless remote controller display occurs.
B: multi system	Operations only remain displayed for a short time after execution of the commands.	Since the indications on the wireless remote controller are turned off, a discrepancy such as described above no longer occurs.

After Setting

Affix corresponding unit number labels onto both air outlet of the decoration panel and onto back of the wireless remote controller.

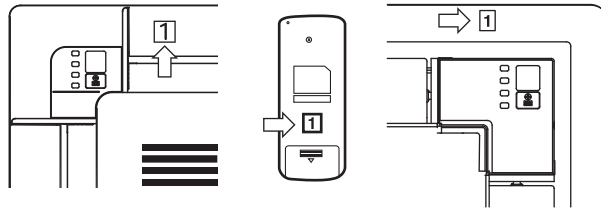

(R24066)



Note: Set the unit No. of the receiver and the wireless remote controller to be the equal. If the settings differ, the signal from the remote controller cannot be transmitted.

6. Silicone Grease on Power Transistor/Diode Bridge

Outline

Apply the specified silicone grease to the heat radiation part of a power transistor/diode bridge when you replace an outdoor unit PCB. The silicone grease encourages the heat radiation of a power transistor/diode bridge.

Details

1. Wipe off the old silicone grease completely.
2. Apply the silicone grease evenly. See the illustrations below for examples of application.
3. Tighten the screws of the power transistor/diode bridge.
4. Make sure that the heat radiation parts are firmly contacted to the radiation fin.

Note: Smoke emission may be caused by bad heat radiation when the silicone grease is not appropriately applied.

- OK: Evenly applied

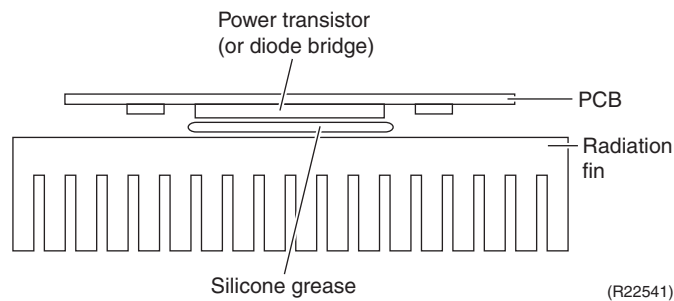

- NG: Not evenly applied

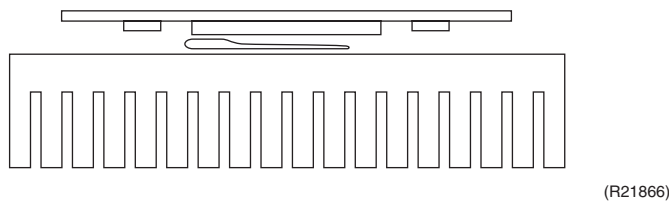

- NG: Foreign matter is stuck.

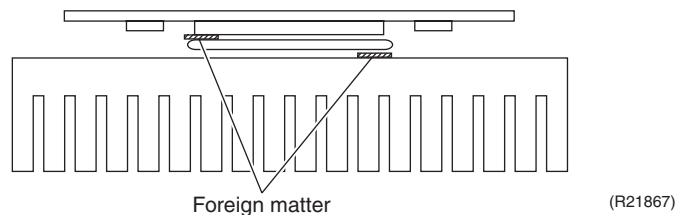

Part 8

Appendix

1. Piping Diagrams.....	229
1.1 Indoor Unit.....	229
1.2 Outdoor Unit.....	232
2. Wiring Diagrams.....	234
2.1 Indoor Unit.....	234
2.2 Outdoor Unit.....	240
3. Operation Limit.....	243

1. Piping Diagrams

1.1 Indoor Unit

CTXG09/12QVJUW(S)

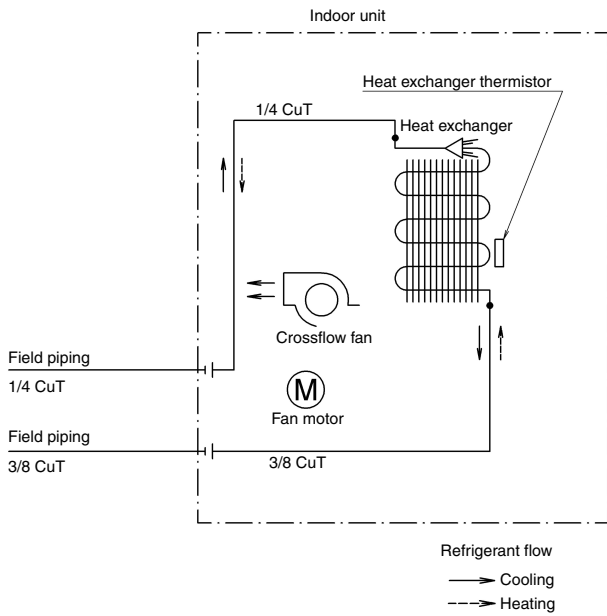

4D101008

CTXG18QVJUW(S)

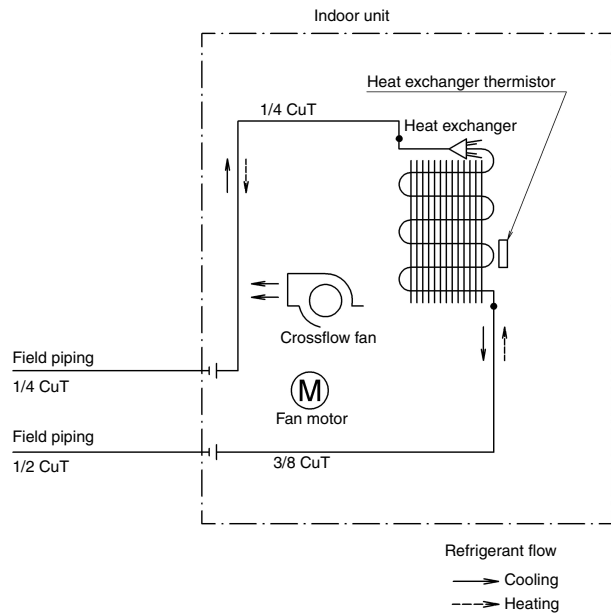

4D101010

CTXS07LVJU, FTXS09/12LVJU

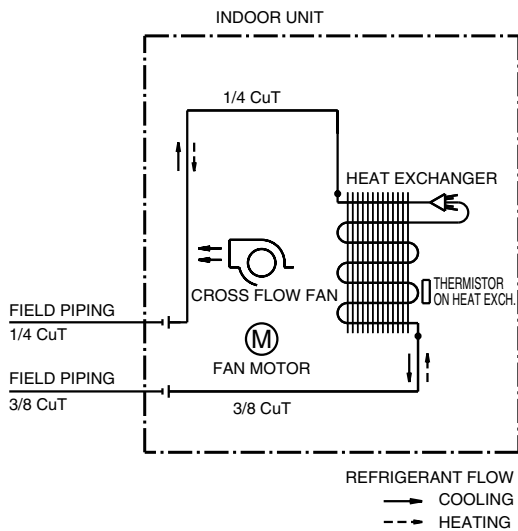

4D074606

FTXS15/18LVJU

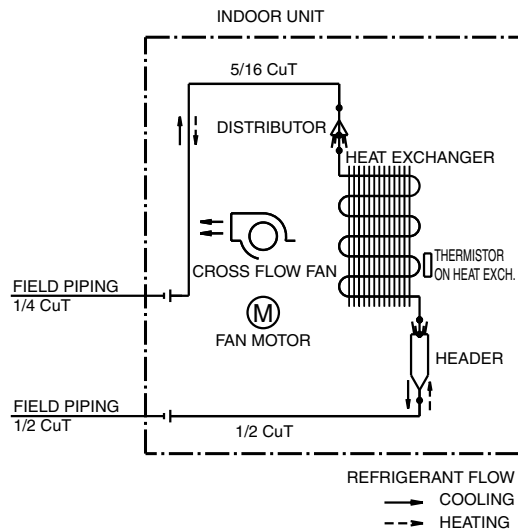

4D074609

FTXS24LVJU

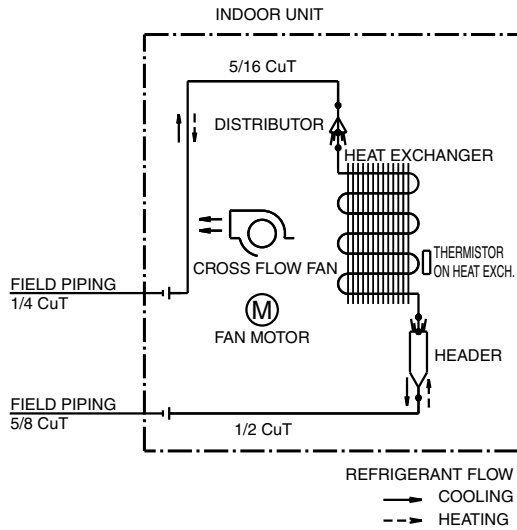

4D074608

FDXS09/12LVJU

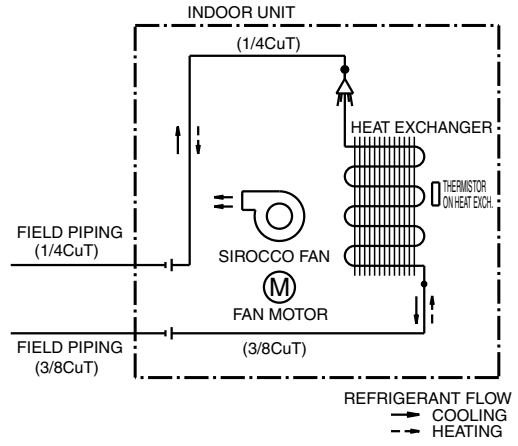

4D074621

CDXS15/18LVJU

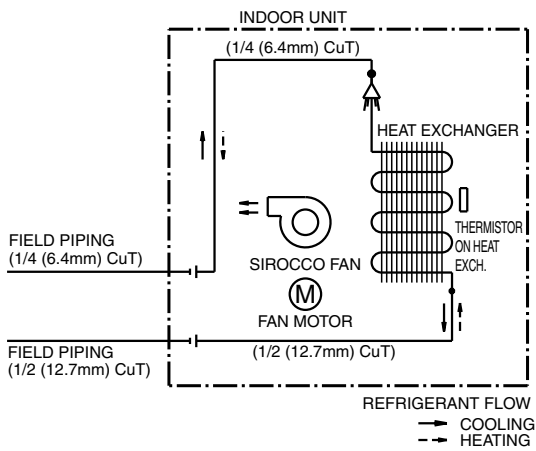

4D075271

CDXS24LVJU

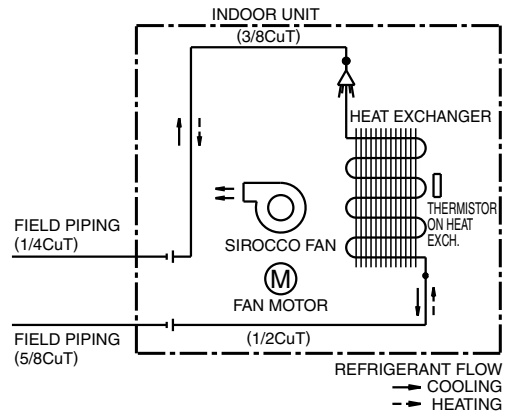

4D080593

FVXS09/12NVJU

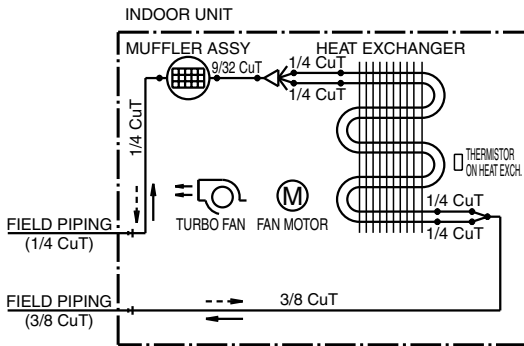

REFRIGERANT FLOW
 —> COOLING
 - - -> HEATING

4D091794

FVXS15/18NVJU

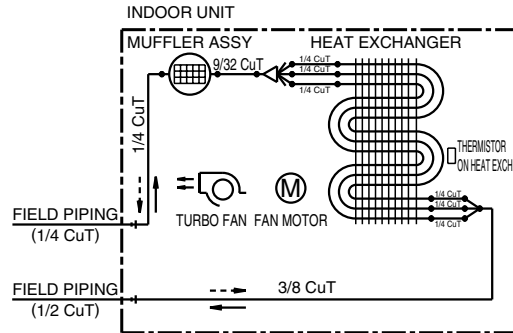

REFRIGERANT FLOW
 —> COOLING
 - - -> HEATING

4D091795A

FFQ09/12/15/18Q2VJU

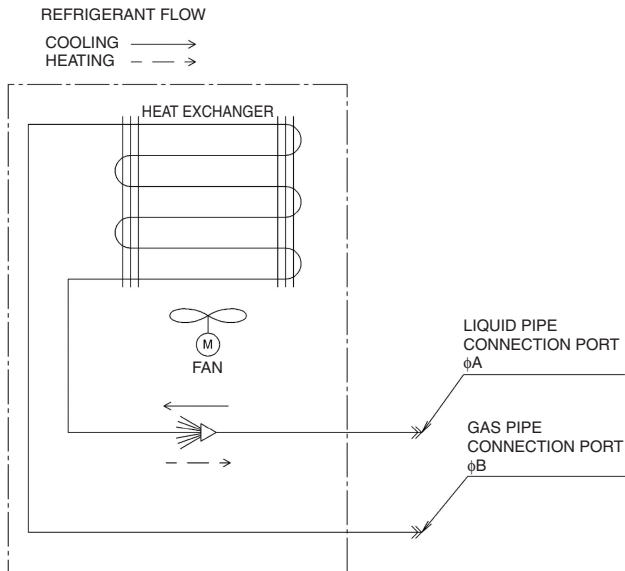

REFRIGERANT FLOW
 COOLING —>
 HEATING - - ->

MODEL	A	B
FFQ09Q2VJU	1/4 (6.4)	3/8 (9.5)
FFQ12Q2VJU		1/2 (12.7)
FFQ15Q2VJU		
FFQ18Q2VJU		

4D106033

1.2 Outdoor Unit

2MXS18NMVJU

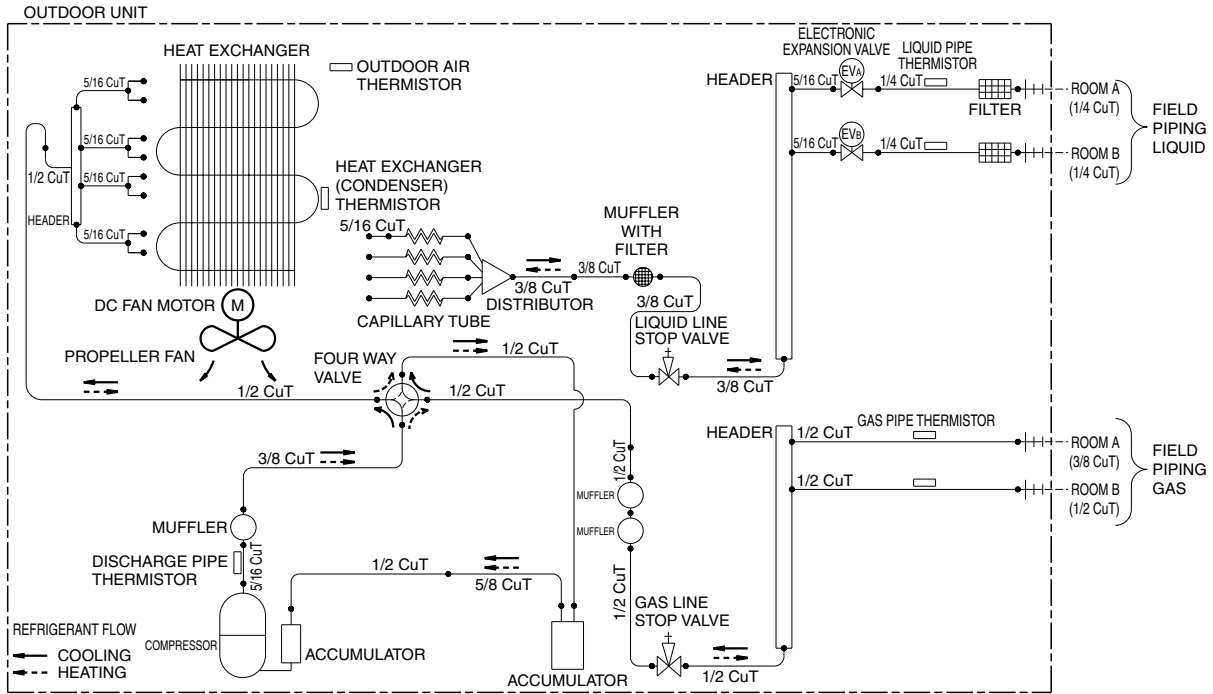

3D093190A

3MXS24NMVJU

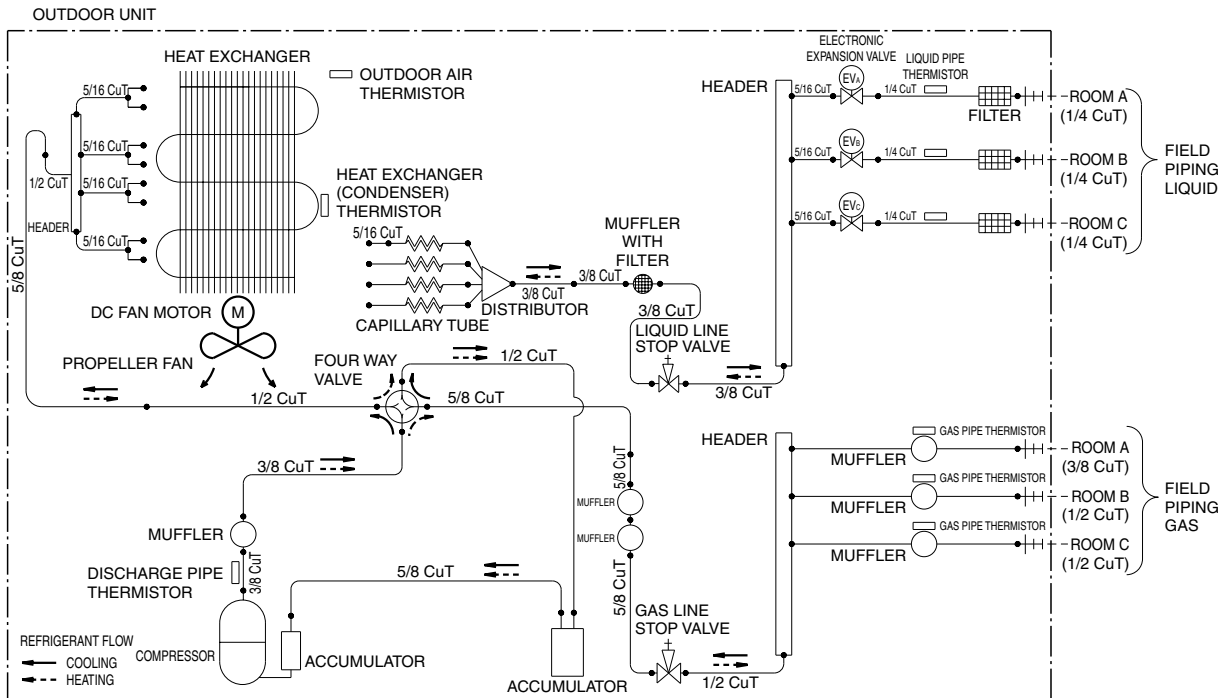

3D093191A

4MXS36NMVJU

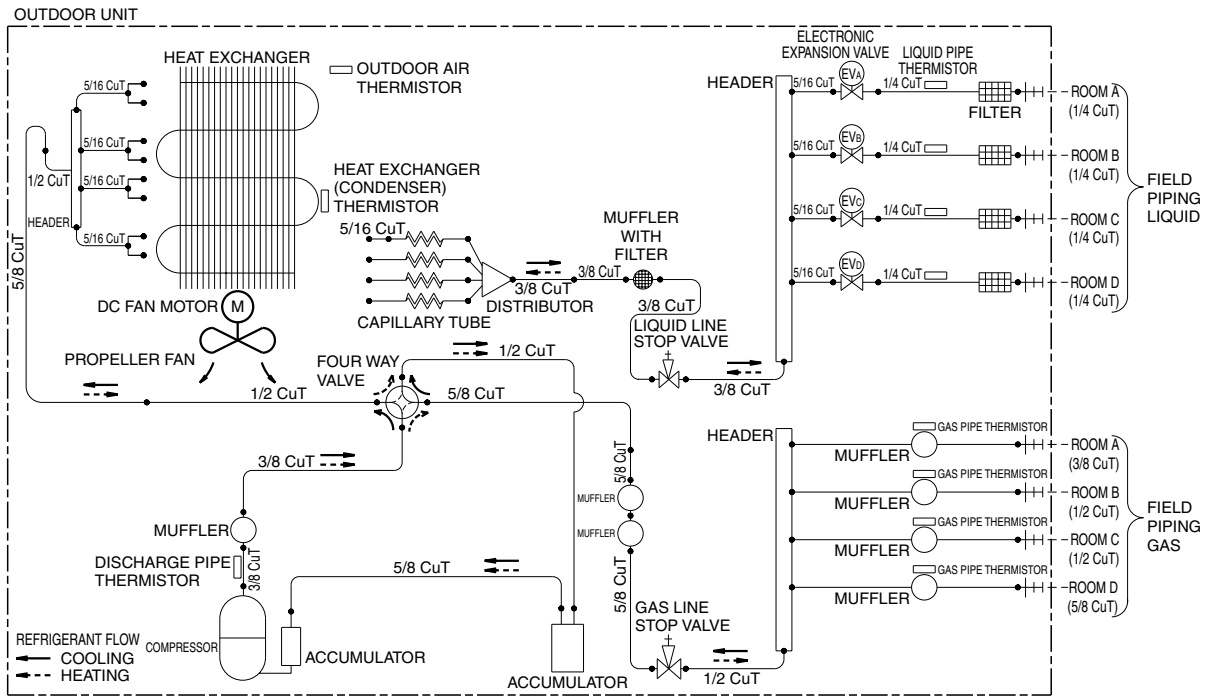

3D093192A

2. Wiring Diagrams

2.1 Indoor Unit

CTXG09/12/18QVJUW(S)

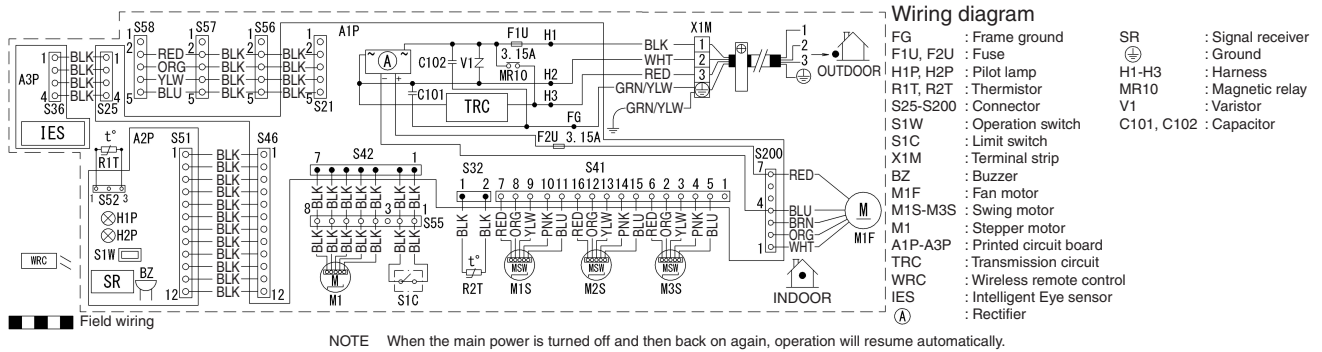

3D103375



Note: A1P: Control PCB
 A2P: Display/signal receiver PCB
 A3P: INTELLIGENT EYE sensor PCB
 Refer to Part 3 for Printed Circuit Board Connector Wiring Diagram.

CTXS07LVJU, FTXS09/12LVJU

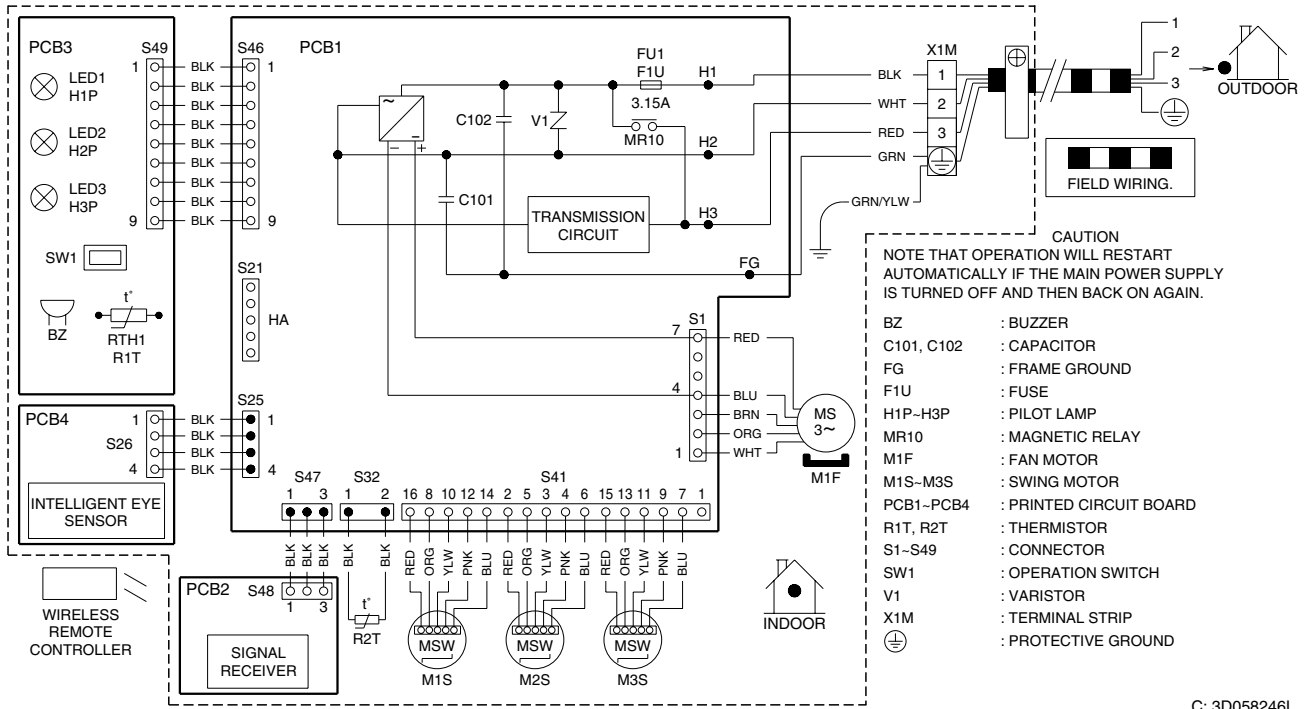

C: 3D058246L



Note: PCB1: Control PCB
 PCB2: Signal receiver PCB
 PCB3: Display PCB
 PCB4: INTELLIGENT EYE sensor PCB
 Refer to Part 3 for Printed Circuit Board Connector Wiring Diagram.

FTXS15/18/24LVJU

WIRING DIAGRAM

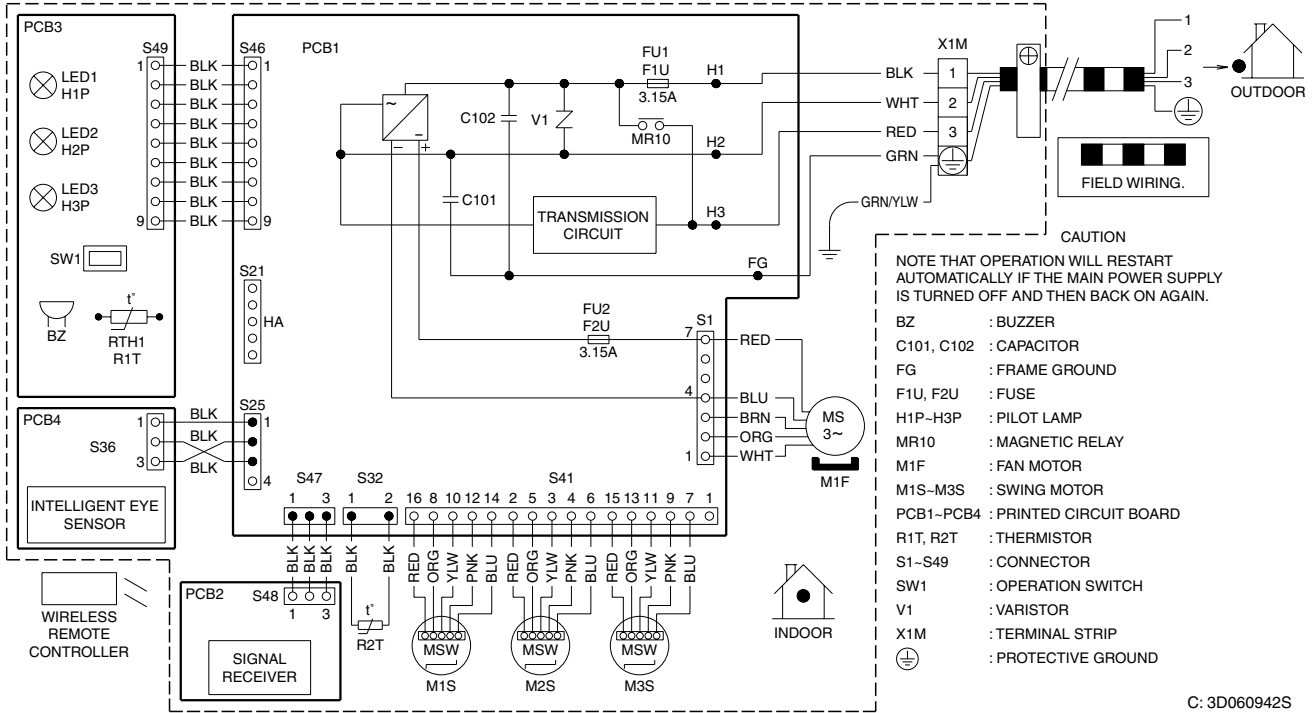

C: 3D060942S



Note: PCB1: Control PCB
 PCB2: Signal receiver PCB
 PCB3: Display PCB
 PCB4: INTELLIGENT EYE sensor PCB
 Refer to Part 3 for Printed Circuit Board Connector Wiring Diagram.

FDXS09/12LVJU, CDXS15/18/24LVJU

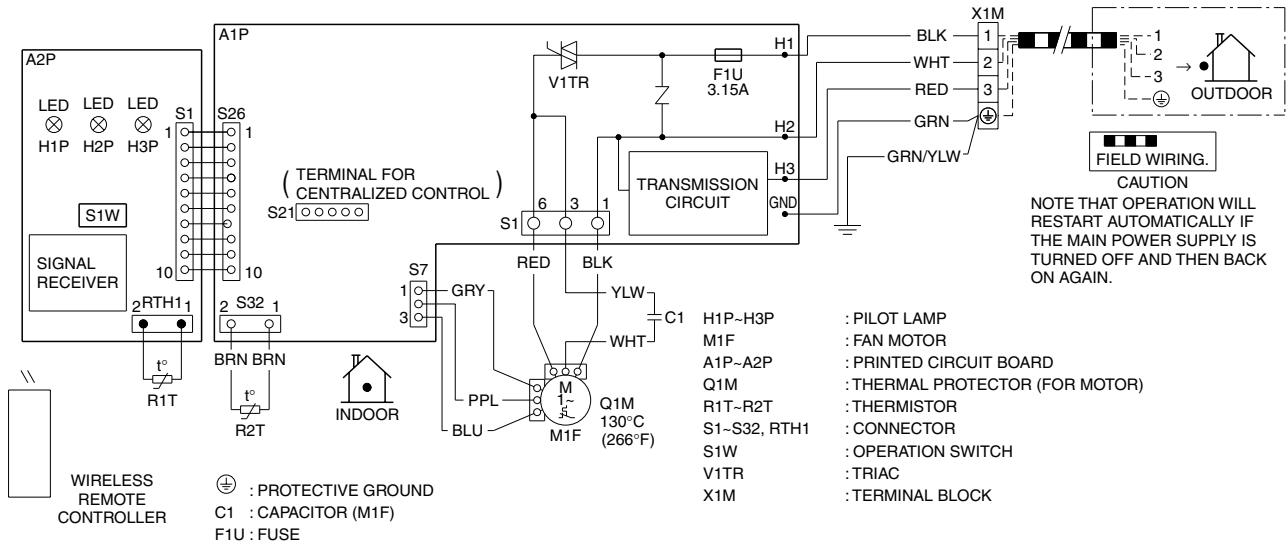

C: 3D073998B



Note: A1P: Control PCB
A2P: Display/signal receiver PCB
Refer to Part 3 for Printed Circuit Board Connector Wiring Diagram.

FVXS09/12/15/18NVJU

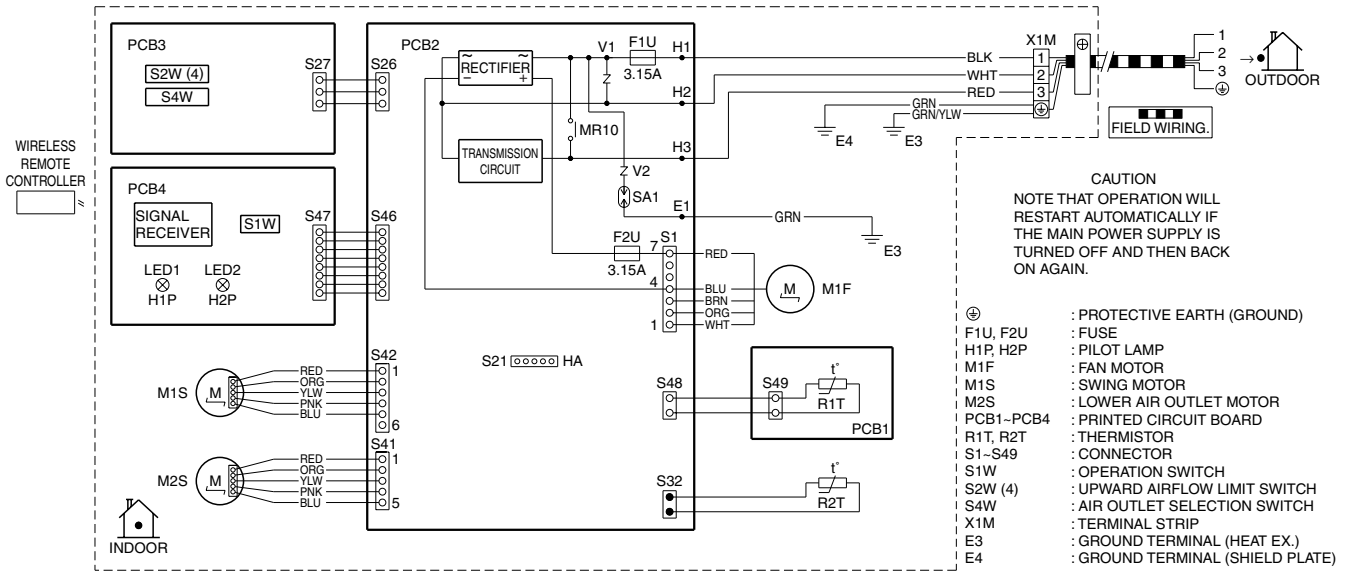

C: 3D090604A



Note: PCB1: Sensor PCB
 PCB2: Control PCB
 PCB3: Service PCB
 PCB4: Display/signal receiver PCB
 Refer to Part 3 for Printed Circuit Board Connector Wiring Diagram.

2.2 Outdoor Unit

2MXS18NMVJU

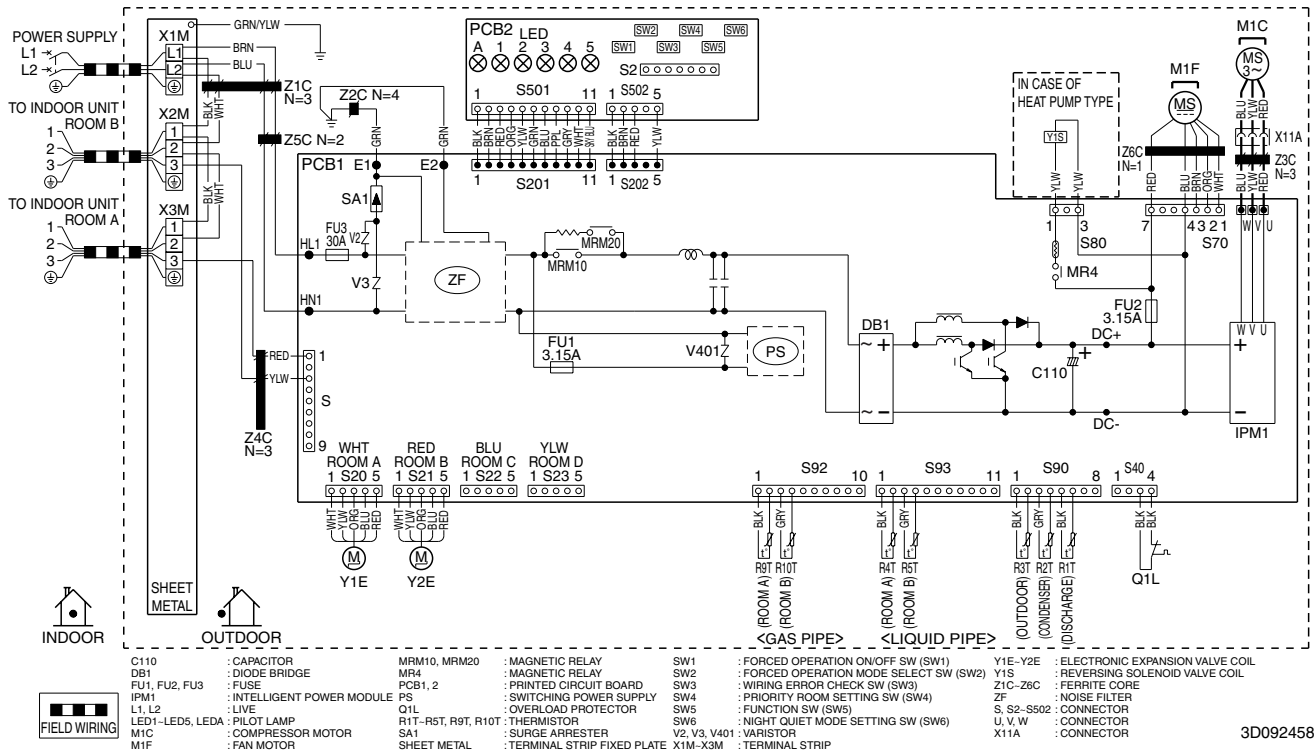

Note: PCB1: Main PCB
 PCB2: Service monitor PCB
 Refer to Part 3 for Printed Circuit Board Connector Wiring Diagram.

3MXS24NMVJU

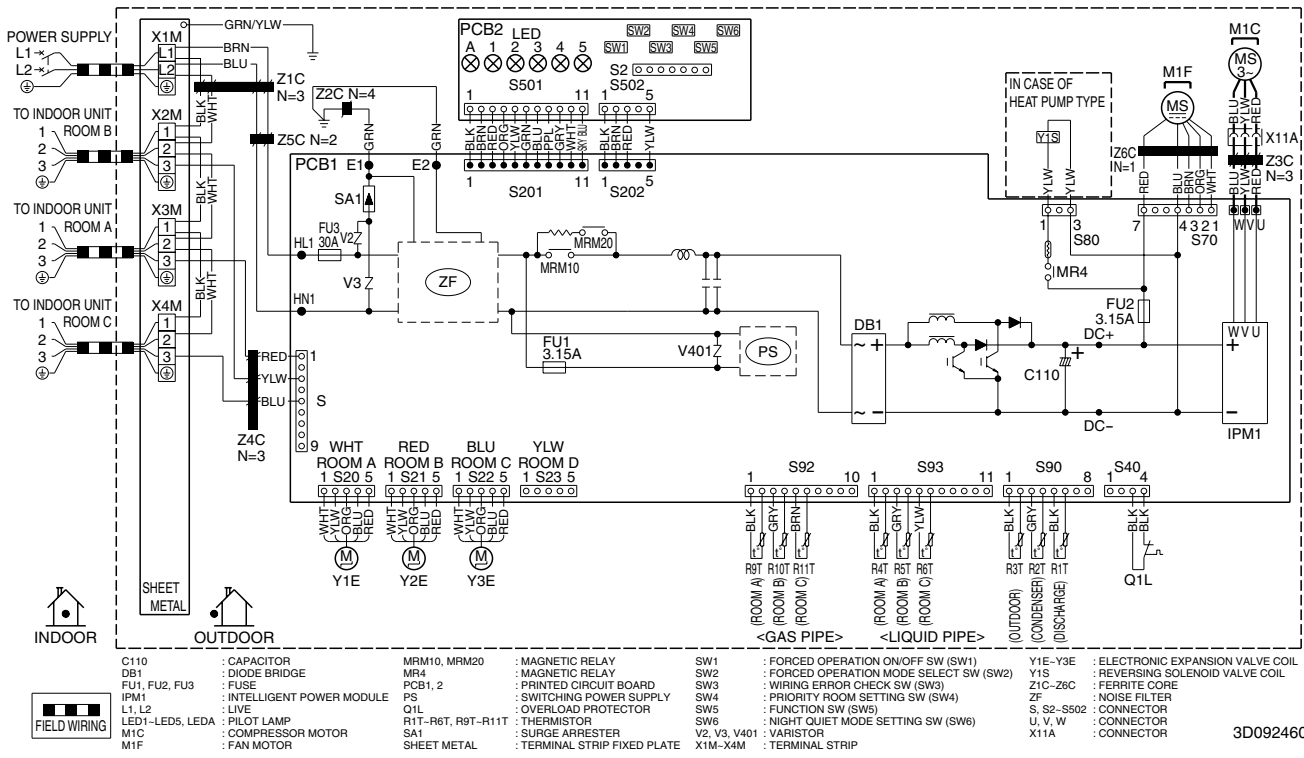

Note: PCB1: Main PCB
 PCB2: Service monitor PCB
 Refer to Part 3 for Printed Circuit Board Connector Wiring Diagram.

4MXS36NMVJU

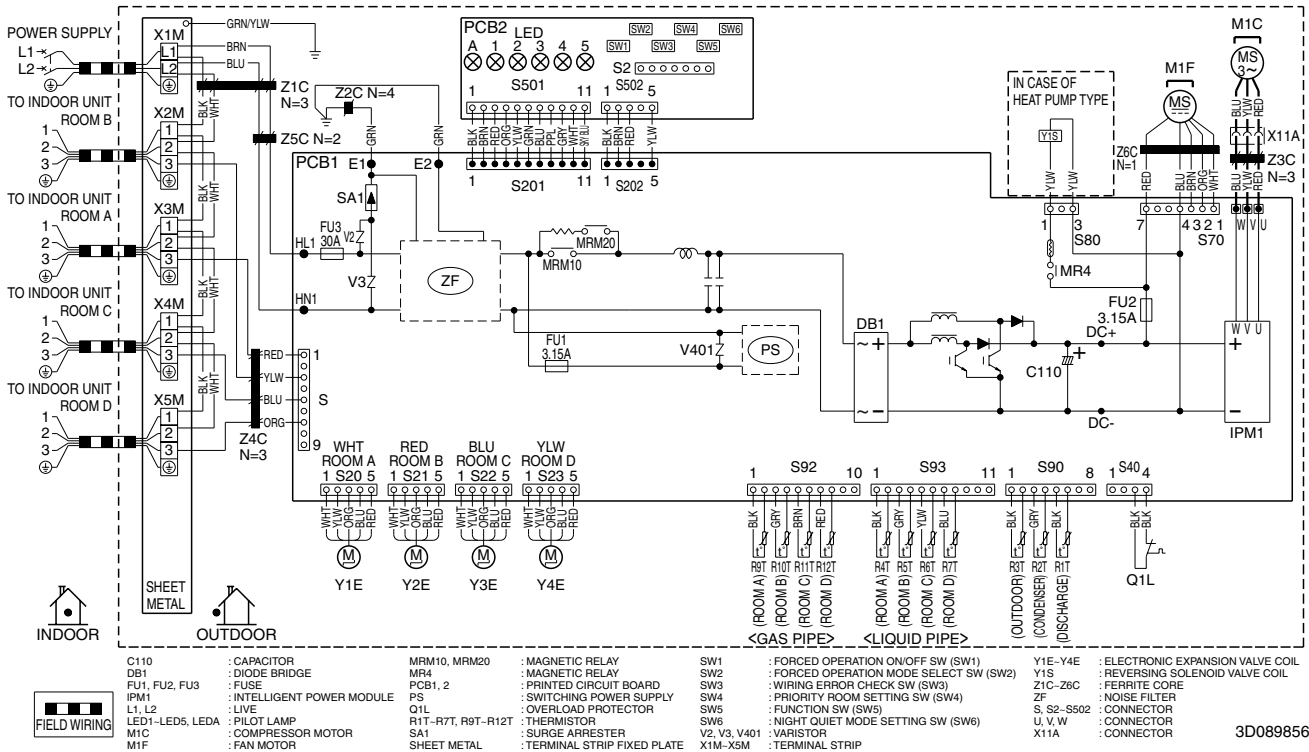

Note: PCB1: Main PCB
 PCB2: Service monitor PCB
 Refer to Part 3 for Printed Circuit Board Connector Wiring Diagram.

3. Operation Limit

2MXS18NMVJU, 3MXS24NMVJU, 4MXS36NMVJU

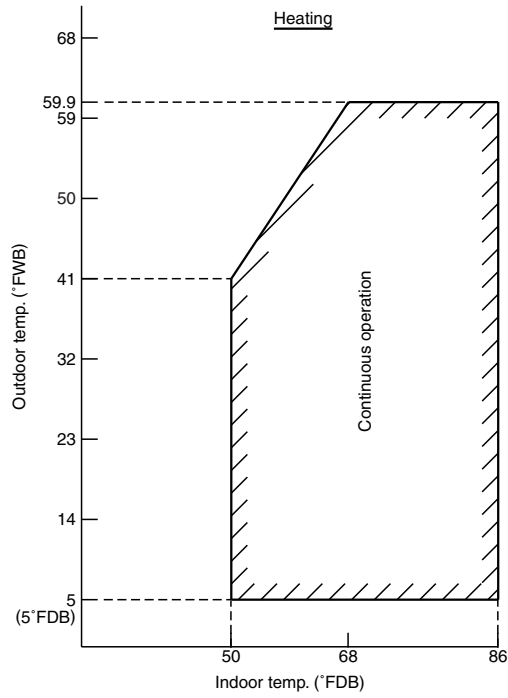
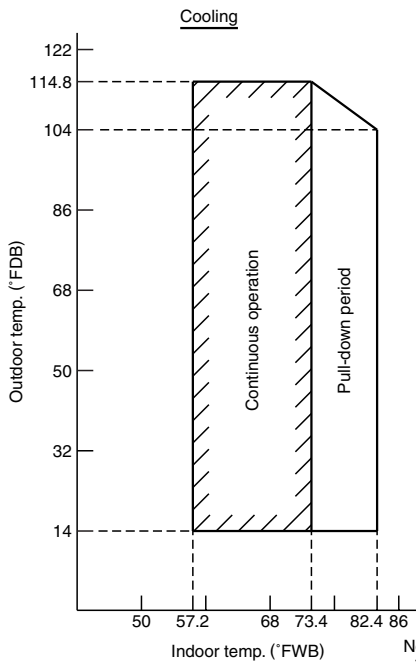

Notes:
 The graphs are based on the following conditions.
 • Equivalent piping length 25ft
 • Level difference 0ft
 • Airflow rate High

3D048149B

Revision History

Month / Year	Version	Revised contents
09 / 2016	SiUS121630E	First edition
03 / 2017	SiUS121630EA	Model addition: FFQ18Q2VJU

Warning



- Daikin products are manufactured for export to numerous countries throughout the world. Prior to purchase, please confirm with your local authorized importer, distributor and/or retailer whether this product conforms to the applicable standards, and is suitable for use, in the region where the product will be used. This statement does not purport to exclude, restrict or modify the application of any local legislation.
- Ask a qualified installer or contractor to install this product. Do not try to install the product yourself. Improper installation can result in water or refrigerant leakage, electrical shock, fire or explosion.
- Use only those parts and accessories supplied or specified by Daikin. Ask a qualified installer or contractor to install those parts and accessories. Use of unauthorized parts and accessories or improper installation of parts and accessories can result in water or refrigerant leakage, electrical shock, fire or explosion.
- Read the user's manual carefully before using this product. The user's manual provides important safety instructions and warnings. Be sure to follow these instructions and warnings.

If you have any inquiries, please contact your local importer, distributor and/or retailer.

Cautions on product corrosion

1. Air conditioners should not be installed in areas where corrosive gases, such as acid gas or alkaline gas, are produced.
2. If the outdoor unit is to be installed close to the sea shore, direct exposure to the sea breeze should be avoided. If you need to install the outdoor unit close to the sea shore, contact your local distributor.

Dealer

© All rights reserved

● Specifications, designs and other content appearing in this brochure are current as of March 2017 but subject to change without notice.